

Radionički nacrt stojnog dijela LM.22-DT.57

Matovina, Luka

Supplement / Prilog

Publication year / Godina izdavanja: **2022**

Permanent link / Trajna poveznica: <https://urn.nsk.hr/urn:nbn:hr:190:426503>

Rights / Prava: [Attribution 4.0 International](#)/[Imenovanje 4.0 međunarodna](#)

Download date / Datum preuzimanja: **2025-01-15**



Repository / Repozitorij:

[Repository of the University of Rijeka, Faculty of Engineering](#)



$\sqrt{\text{Ra } 6.3}$

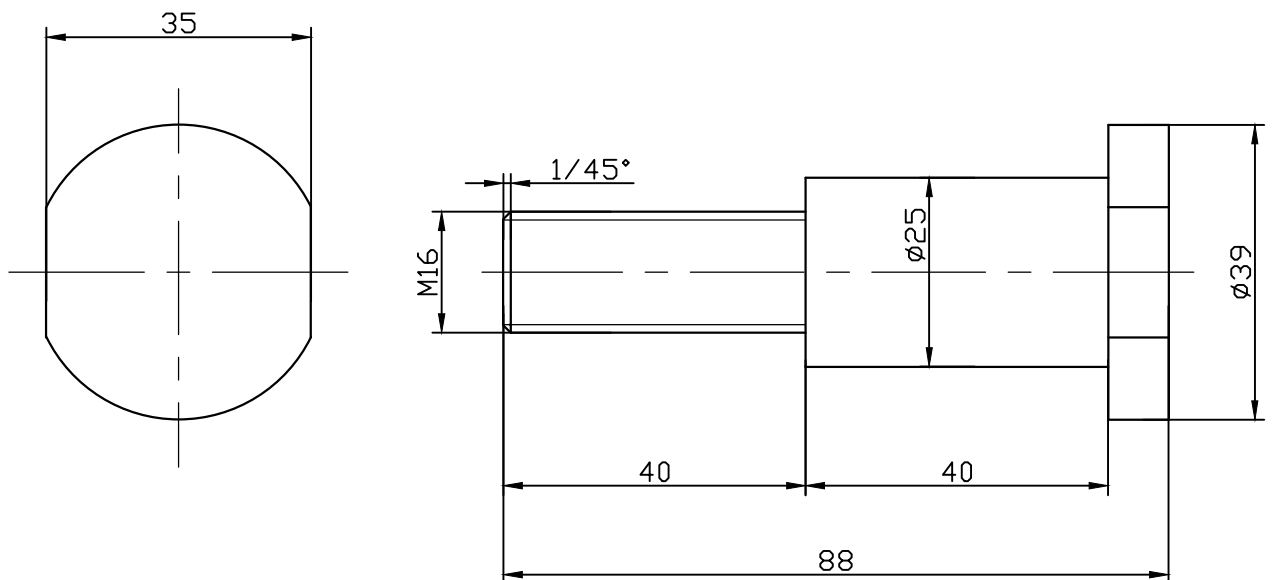

NAPOMENE:

1) Poboľjšati na 30^{+2} HRC

Ime i prezime: L.Matovina		Datum: 1.6.2022	Masa (kg): 0,08	Mjerilo: 1:1
 Sveučilište u Rijeci TEHNIČKI FAKULTET 51000 RIJEKA, Vukovarska 58, HRVATSKA	Prilog 1	Materijal: 42CrMo4	Količina: 1	
	Naziv dijela: LM.22-DT57			