

Podjela broda u grupe

Donadić, Dorian

Supplement / Prilog

Publication year / Godina izdavanja: **2022**

Permanent link / Trajna poveznica: <https://urn.nsk.hr/urn:nbn:hr:190:754651>

Rights / Prava: [Attribution 4.0 International](#)/[Imenovanje 4.0 međunarodna](#)

Download date / Datum preuzimanja: **2024-07-20**



Repository / Repozitorij:

[Repository of the University of Rijeka, Faculty of Engineering](#)



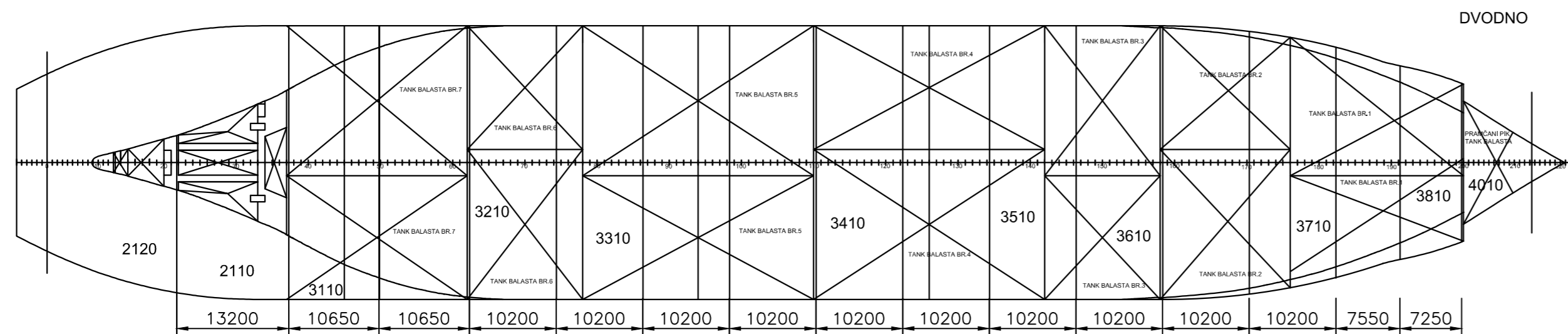
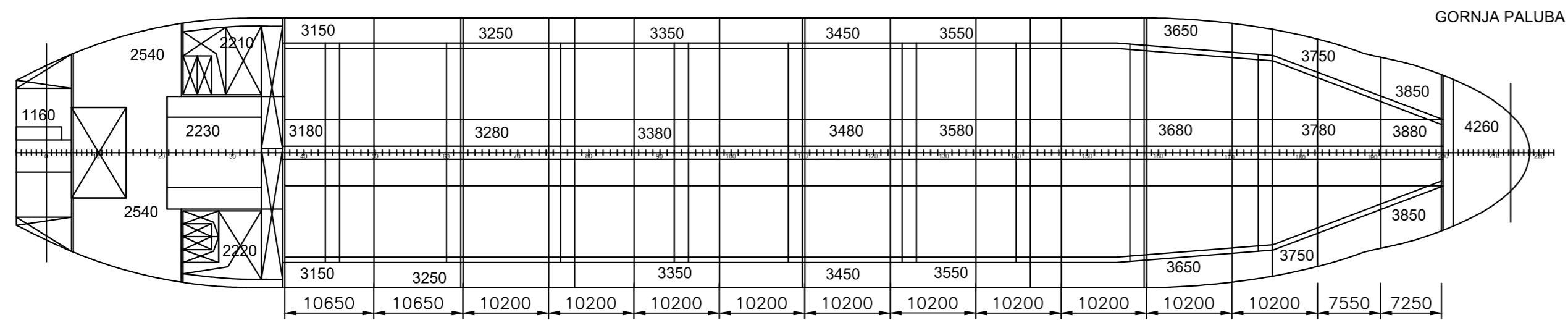
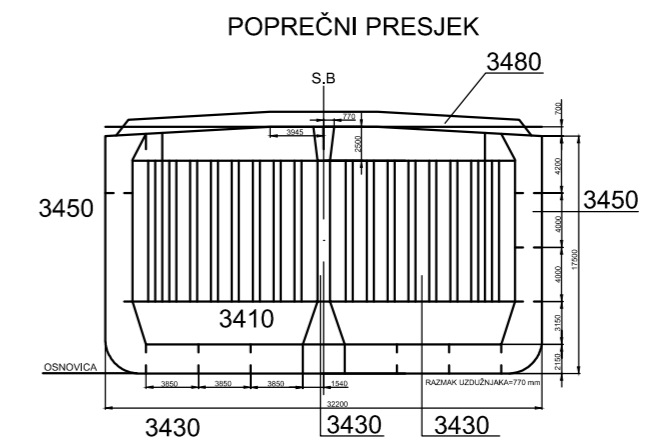
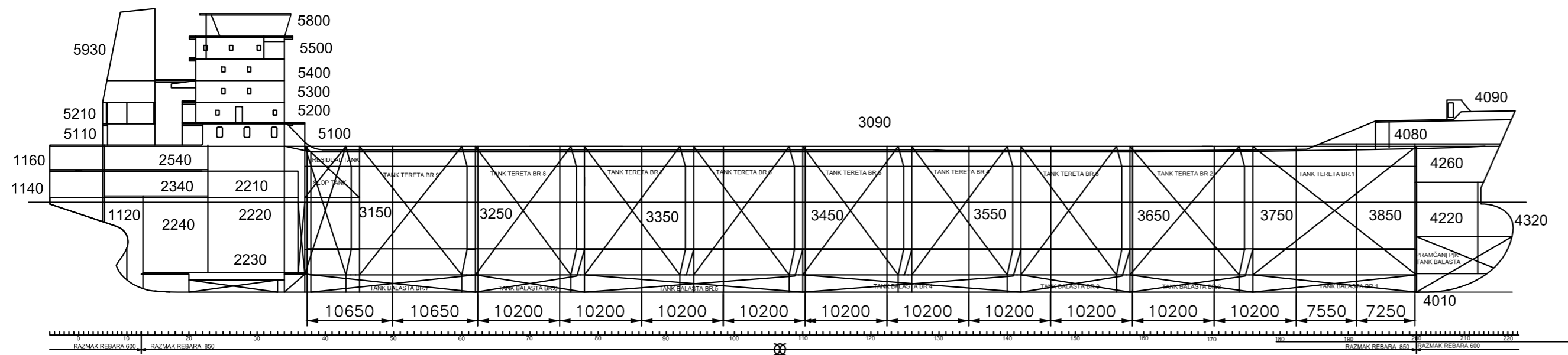

TANKER ZA PRIJEVOZ NAFTNIH PRERAĐEVINA I KEMIČALIJA
50000 DWT

DULJINA PREKO SVEGA	182,80 m
DULJINA IZMEĐU OKOMICA	174,80 m
ŠIRINA	32,20 m
VISINA	17,50 m
GAZ	11,20 m

Naziv sklopa:	Datum	Ime i mat. br.	Potpis	Diplomski rad	Mjerilo:
	Nacrtao:	27.06.2022	Dorian Donadić 0069079747		
Broj skl. crteža:	Provjerio:			List / listova: 1/1	
		Odobrio:			Akademski godina 2021/2022
Tehnički fakultet Rijeka	Naziv dijela: Podjela broda u grupe			Broj crteža:	