

Sklop CR

Donadić, Dorian

Supplement / Prilog

Publication year / Godina izdavanja: **2022**

Permanent link / Trajna poveznica: <https://urn.nsk.hr/urn:nbn:hr:190:485635>

Rights / Prava: [Attribution 4.0 International](#)/[Imenovanje 4.0 međunarodna](#)

Download date / Datum preuzimanja: **2024-11-27**



Repository / Repozitorij:

[Repository of the University of Rijeka, Faculty of Engineering](#)



CR043

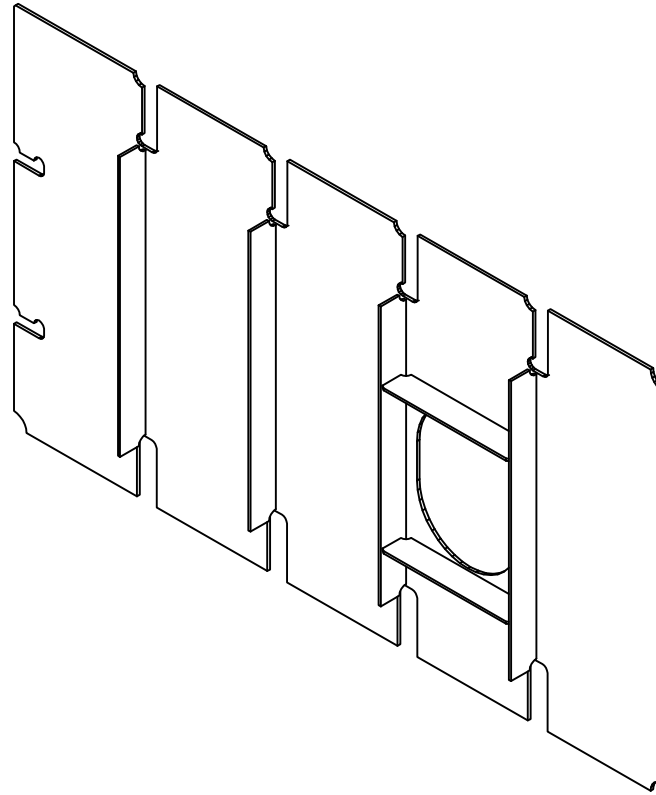

OZNAKA	RAD.MARKA	NAZIV	BROJ	DIMENZIJE	KV.MAT.	MASA [kg]
CT3410-X122F/S*	577	profil	2	FB10: 150x12.0 L=758.00	A	21.5
CT3410-X122F/S*	569	profil	4	FB10: 150x12.0 L=1530.00	A	87.2
CT3410-X122F-1P	278	lim	1	15.50	AH36	926.6

A4TEHNOL

SEKCIJA:	KP12	KP22					GRADNJA: 722,723	NACRT BROJ: 4-341-010	LIST: LISTOVA:	TEZINA: 1035.243 TEZISTE X: FR122
BROJ SKLOPOVA:	1	1					SKLOP: 3410-VT02-KP12-CR043 X122CL			TEZISTE Y: 11175 TEZISTE Z: 1079
							DATUM:			