

# UTJECAJ NADGRAĐA NA UZDUŽNU ČVRSTOĆU OBOSTRANO UKRCAJNOG TRAJEKTA ZA AUTOMOBILE

---

**Vojnić, Dora**

**Master's thesis / Diplomski rad**

**2024**

*Degree Grantor / Ustanova koja je dodijelila akademski / stručni stupanj:* **University of Rijeka, Faculty of Engineering / Sveučilište u Rijeci, Tehnički fakultet**

*Permanent link / Trajna poveznica:* <https://um.nsk.hr/um:nbn:hr:190:542299>

*Rights / Prava:* [Attribution 4.0 International](#)/[Imenovanje 4.0 međunarodna](#)

*Download date / Datum preuzimanja:* **2024-07-23**



*Repository / Repozitorij:*

[Repository of the University of Rijeka, Faculty of Engineering](#)



SVEUČILIŠTE U RIJECI  
TEHNIČKI FAKULTET

Diplomski sveučilišni studij brodogradnje

Diplomski rad

**UTJECAJ NADGRAĐA NA UZDUŽNU ČVRSTOĆU  
OBOSTRANO UKRCAJNOG TRAJEKTA ZA AUTOMOBILE**

Rijeka, siječanj 2024.

Dora Vojnić

0035204093

SVEUČILIŠTE U RIJECI  
TEHNIČKI FAKULTET

Diplomski sveučilišni studij brodogradnje

Diplomski rad

**UTJECAJ NADGRAĐA NA UZDUŽNU ČVRSTOĆU  
OBOSTRANO UKRCAJNOG TRAJEKTA ZA AUTOMOBILE**

Mentor: prof. dr. sc. Albert Zamarin

Rijeka, siječanj 2024.

Dora Vojnić

0035204093

Rijeka, 16. ožujka 2023.

Zavod: **Zavod za brodogradnju i inženjerstvo morske tehnologije**  
Predmet: **Strukturalna analiza broda**  
Grana: **2.02.01 konstrukcija plovnih i pučinskih objekata**

## ZADATAK ZA DIPLOMSKI RAD

Pristupnik: **Dora Vojnić (0035204093)**  
Studij: **Sveučilišni diplomski studij brodogradnje**  
Modul: **Projektiranje i konstrukcija plovnih objekata**

Zadatak: **UTJECAJ NADGRAĐA NA UZDUŽNU ČVRSTOĆU OBOSTRANO UKRCAJNOG TRAJEKTA ZA AUTOMOBILE / SENSITIVITY ANALYSIS OF THE SUPERSTRUCTURE ON THE LONGITUDINAL STRENGTH OF THE DOUBLE ENDED FERRY**

### Opis zadatka:

Za predloženi trajekt za prijevoz putnika i automobila sa obostranim ukrcajnim rampama i za ograničeno područje plovidbe u Jadranu, te priloženu preliminarnu dokumentaciju (opći plan, nacrt glavnog rebra, knjiga trima i stabiliteta) potrebno je analizirati utjecaj nadgrađa na uzdužnu čvrstoću. Pri tome koristiti kombinaciju metode konačnih elemenata primjenom nekog od priznatih programskih paketa opće namjene i programskog paketa za preliminarno projektiranje strukture trupa broda MARS 2000. U tu je svrhu potrebno napraviti slijedeće:

- računalni model strukture cijelog broda,
- definirati opterećenje primjenom projektnih opterećenja iz pravila i propisa ili koristeći podatke iz knjige trima i stabiliteta za proračun vertikalnog momenta savijanja i vertikalne smične sile na mirnoj vodi, te vrijednosti vertikalnog valnog momenta savijanja i smične sile prema pravilima i propisima klasifikacijskog društva (HRB ili BV),
- provesti FE analizu globalne čvrstoće za odabrano najnepovoljnije stanje krcanja i za tri nivoa uključenosti strukture (do glavne palube, do putničke palube i do palube kormilarnice).
- provesti analizu mogućnosti uključivanja struktura nadgrađa u proračun uzdužne (globalne) čvrstoće trupa broda kombinacijom rezultata FEA i varijacije postotka uključenosti elemenata iznad glavne palube kroz MARS 2000 programski paket.

Prilikom analize voditi računa i o lokalnim kriterijima čvrstoće na izvijanje (HRB).

Rad mora biti napisan prema Uputama za pisanje diplomskih / završnih radova koje su objavljene na Zadatku i učenjima pristupnika. 20. ožujka 2023.

Mentor:

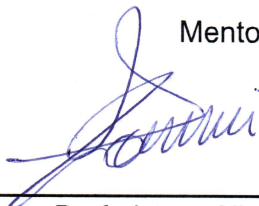

Prof. dr. sc. Albert Zamarin

Predsjednik povjerenstva za  
diplomski ispit:

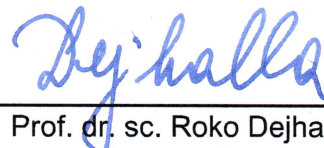

Prof. dr. sc. Roko Dejhalla

SVEUČILIŠTE U RIJECI

TEHNIČKI FAKULTET

Diplomski sveučilišni studij brodogradnje

## IZJAVA

Sukladno Pravilniku o diplomskom radu, diplomskom ispitu i završetku diplomskih sveučilišnih studija Tehničkog fakulteta u Rijeci, izjavljujem da sam samostalno izradila diplomski rad naslova „Utjecaj nadgrađa na uzdužnu čvrstoću obostrano ukrcajnog trajekta za automobile“ koristeći se znanjem stečenim tijekom studija uz konzultacije s mentorom.

Rijeka, siječanj 2024.

Dora Vojnić

---

## ZAHVALA

Ovim putem zahvaljujem se profesoru i mentoru prof. dr. sc. Albertu Zamarinu i asistentu dipl. ing. Davoru Bolfu na uloženom vremenu, smjericama za pisanje i strpljenju.

Također, zahvaljujem svojoj obitelji, kolegama i prijateljima na podršci, a posebno Ivi i Nikoli bez koji ovaj fotofiniš ne bi bio moguć, a onda i Anti i Mišelu bez kojih bi cijelo iskustvo akademskog školovanja bilo puno usamljenije.

## Sadržaj

1. Uvod.....	2
2. Brodovi za prijevoz tereta na kotačima i putnika .....	4
2.1. Strukturne specifičnosti .....	5
2.2. Računalni model strukture .....	8
3. Dimenzioniranje strukture po pravilima i propisima klasifikacijskog društva .....	11
3.1. Opterećenja brodske konstrukcije.....	12
3.2. Dimenzioniranje oplata .....	15
3.3. Uzdužna čvrstoća .....	17
3.4. Izvijanje.....	21
4. Analiza metodom konačnih elemenata .....	23
4.1. Omrežavanje geometrije .....	23
4.2. Rubni uvjeti.....	25
4.3. Prikaz rezultata.....	27
5. Utjecaj nadgrađa na uzdužnu čvrstoću trupa broda .....	40
6. Zaključak.....	44
LITERATURA .....	45
POPIS OZNAKA I KRATICA .....	46
SAŽETAK I KLJUČNE RIJEČI.....	47
DODATAK A – Dimenzioniranje strukture po pravilima Hrvatskog registra brodova.....	48
DODATAK B – Ekvivalentne grede s obzirom na otporni moment.....	104
DODATAK C – Rezultati iz programskog paketa MARS 2000.....	108

## 1. Uvod

Današnje vrijeme karakterizirano je izrazito brzim razvojem industrije i novih tehnologija. Od toga nije izuzeta ni brodska i pomorska industrija u kojoj dolazi do brze evolucije metodologija projektiranja i izgradnje, potaknute od strane industrije pomorskog prometa. S obzirom da je prijevoz brodom i dalje najefikasniji oblik prijevoza, raste potreba za složenim i izdržljivim plovilima, sposobnim za prijevoz putnika i tereta, nerijetko u teškim okolišnim uvjetima.

Jedan od primjera takvih plovila je i trajekt za prijevoz putnika i automobila sa obostrano ukrcajnim rampama (*engl. double-ended ferry*). Njegov jedinstveni dizajn, koji omogućuje česte plovidbe u složenim morskim uvjetima, postavlja izazov u projektiranju strukture, posebno u njegovoj uzdužnoj čvrstoći. Budući da ovi trajekti često prevoze značajan broj putnika i vozila, održavanje njihove sigurnosti i strukturalnog integriteta plovila postaje izrazito važno. Kada se ovome doda sve veće pritiske pomorskih propisa, standarda i ciljeva održivosti i korištenja zelenih tehnologija; jasno je zašto brodograđevni inženjeri neprestano teže optimiziranim rješenjima koji pružaju i funkcionalnost i sigurnost.

Ovaj rad bavi se strukturnom analizom i utjecajem nadgrađa na uzdužnu čvrstoću navedenog plovila. Duljina broda je značajno veća od njegove širine i visine te iz tog razloga uzdužna čvrstoća igra bitnu ulogu. Uzdužna čvrstoća definira se kao sposobnost brodske konstrukcije da u cijelosti i mjestimično preuzme i izdrži djelovanje vanjskog opterećenja za cijeli životni vijek broda. Nadgrađe je struktura koja je natkrivena palubom, nalazi se iznad palube nadvođa i prostire se od boka do boka broda, ili struktura čije bočne stijenke nisu udaljene od oplata za više od 4% širine broda. Nadgrađe koje se proteže najmanje 15% duljine broda unutar 0,4L u sredini broda (20% duljine broda sa svake strane glavnog rebra) općenito se može smatrati relevantnim za proračun uzdužne čvrstoće (*engl. effective superstructure*). Utjecaj ostalih nadgrađa i palubnih kućica treba se procijeniti od slučaja do slučaja putem analize metodom konačnih elemenata koja uzima u obzir opći raspored uzdužnih strukturnih elemenata (bokova, paluba, pregrada, itd.). Analiza metodom konačnih elemenata (*engl. Finite Element Analysis*; u daljnjem tekstu FEA ili MKE) je danas standardni računalni alat koji omogućuje inženjerima da simuliraju uvjete u stvarnom svijetu, pružajući detaljniji uvid u to kako se različiti dijelovi broda ponašaju pod različitim opterećenjima.



U prvom poglavlju biti će riječ općenito o trajektima i opisati će se obostrano ukrcajni trajekt za kojeg je potrebno provesti analizu. U drugom poglavlju biti će naveden proračun po pravilima klasifikacijskog društva koji je korišten za postavke analize metodom konačnih elemenata koja će biti pobliže objašnjena u trećem poglavlju. U četvrtom poglavlju provesti će se analiza mogućnosti uključivanja struktura nadgrađa u proračun uzdužne (globalne) čvrstoće trupa broda kombinacijom rezultata FEA i varijacije postotka uključenosti elemenata iznad glavne palube. U zaključku će se napraviti sinteza podataka i rezultata analiza napravljenih u radu.

Cilj ovoga rada je temeljem strukturne analize metodom konačnih elemenata analizirati utjecaj nadgrađa na uzdužnu čvrstoću obostrano ukrcajnog trajekta. U tu su svrhu korišteni sljedeći programski paketi: Rhinoceros 7.0 za izradu modela, Siemens FEMAP za provođenje analize metodom konačnih elemenata te MARS 2000 za varijacije postotka uključenosti elemenata iznad glavne palube i njihov utjecaj na rezultate.

## 2. Brodovi za prijevoz tereta na kotačima i putnika

Brodovi za prijevoz tereta na kotačima (*engl. Roll-on Roll-off*; skraćeno Ro-Ro) služe za prijevoz raznovrsnog tereta, od auta i kamiona pa sve do prikolica i vagona. U većini slučajeva, Ro-Ro brod ima pokrov dvodna, palubu nadvođa ili glavnu palubu i još jednu palubu nadgrađa (osim u slučaju brodova za prijevoz automobila koji imaju veći broj paluba). Tim se brodovima može prevoziti i teret koji nije na kotačima ako se ukrca i iskrcava dizalicom, što se uglavnom koristi za prijevoz kontejnera ili drugog glomaznog tereta na gornjoj palubi. Osim tereta, mogu prevoziti do dvanaest putnika, što je ograničenje za teretne brodove po SOLAS-u.

Ukoliko takav brod prevozi više od dvanaest putnika, riječ je o trajektu za prijevoz vozila i putnika (*engl. Roll-on Roll-off Passenger*; Ro-Pax). Njih karakterizira barem jedna paluba za vozila i jedna ili više paluba za smještaj putnika. Uglavnom su građeni tako da se vozila mogu ukrcati na jednoj strani broda, a iskrcati na drugoj. Ro-Pax brodovi koji redovno prevoze teret i putnike na kraćim relacijama nazivaju se trajektima. Trajekti takve vrste uglavnom su duljine dvadeset i pet do dvjesto pedeset metara. Uobičajena brzina im je do trideset čvorova. Primjer takvog plovila prikazan je na slici 2.1.



Slika.22.1.1 - Jadrolinijin trajekt Jadran [1]

## 2.1. Strukturne specifičnosti

Plovilo koje je tema ovog rada je obostrano ukrajni trajekt za prijevoz putnika i tereta kojemu je putanja ograničena na hrvatske vode. Preliminarni nacrt glavnog rebra prikazan je na slici 2.1.1, a opći plan na slici 2.1.2. Glavne dimenzije broda prikazane su u tablici 2.1.1.

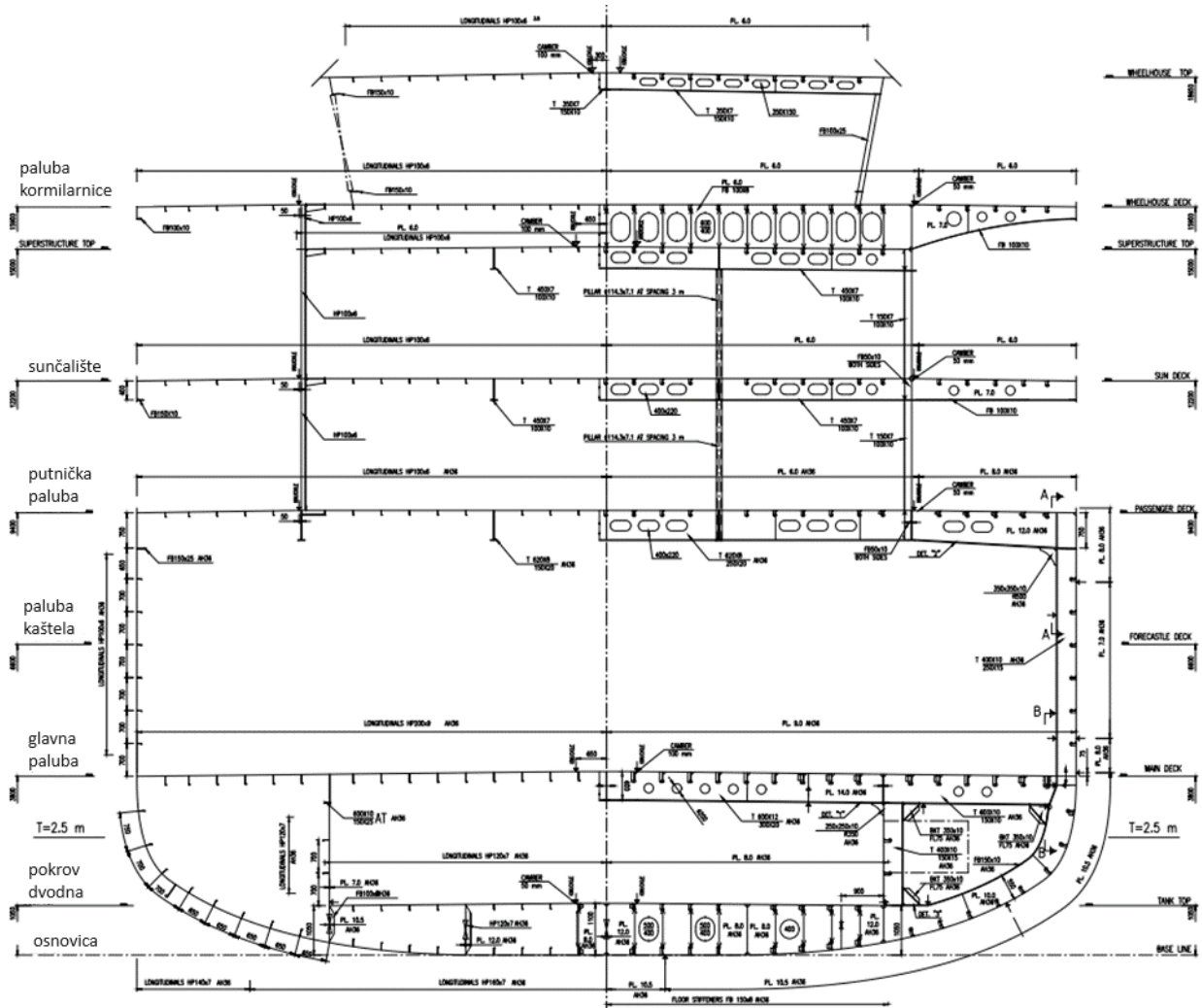

Slika 2.1.1 – Glavno rebro

Palube se nalaze na sljedećim visinama:

- ➔ pokrov dvodna na 1050 mm od osnovice
- ➔ glavna paluba na 3800 mm od osnovice
- ➔ paluba kaštela na 6600 mm od osnovice
- ➔ putnička paluba na 9400 mm od osnovice
- ➔ sunčalište na 12200 mm od osnovice
- ➔ paluba kormilarnice na 15900 mm od osnovice

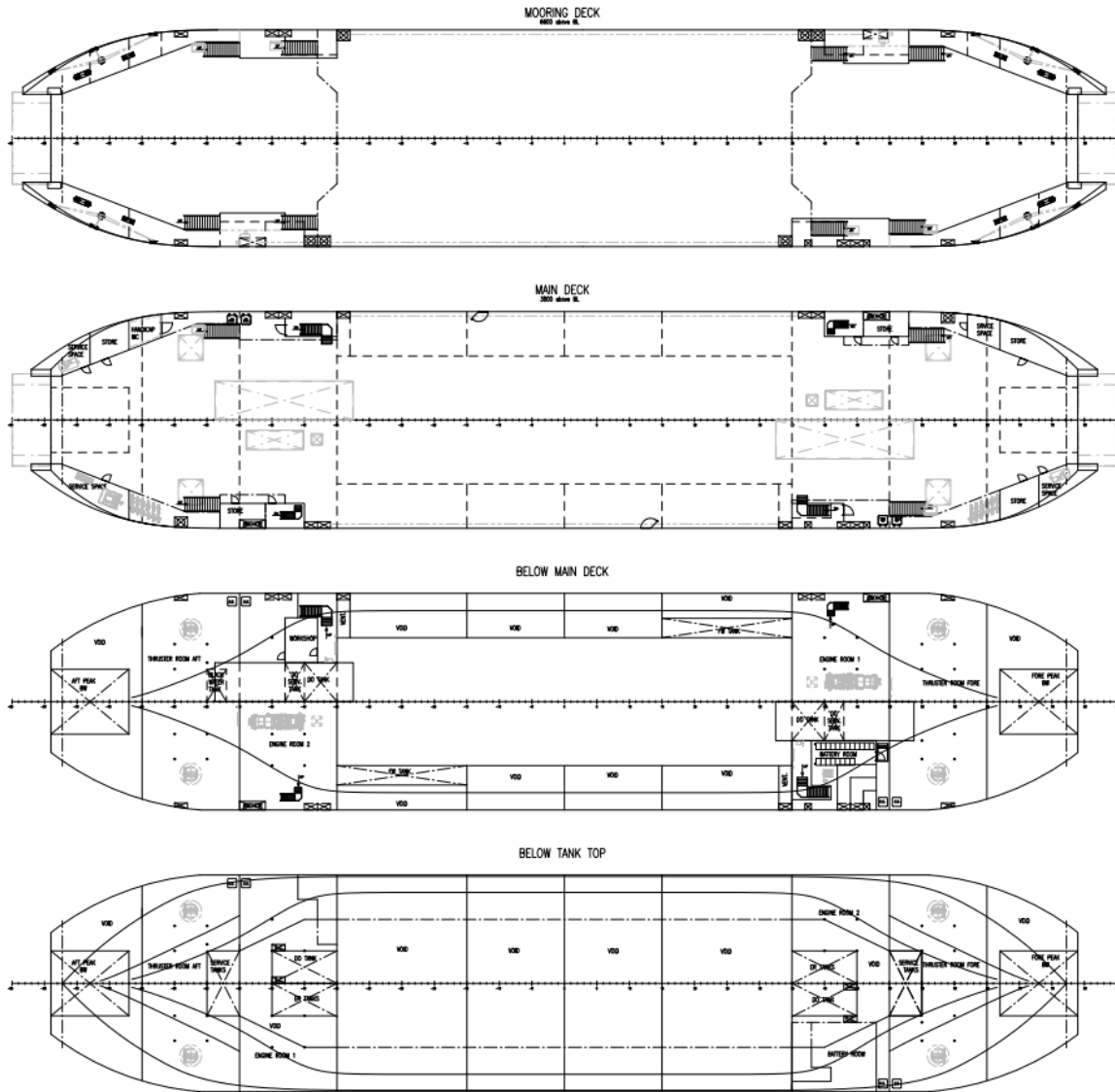

Slika 2.1.2 - Opći plan

Tablica 2.1.1 - Glavne dimenzije plovila

Duljina preko svega	101.9	m
Duljina između perpendikulara	92.7	m
Registarska širina	20.0	m
Visina dvodna (na glavnom rebru)	1.05	m
Visina do glavne palube (na glavnom rebru)	3.8	m
Maksimalni gaz	2.5	m
Nosivost (na maksimalnom gasu)	Oko 1000	t
Bruto tonaža	4860	GT

Plovilo ima zatvorenu garažu za smještaj vozila u potpalublju, otvorenu glavnu palubu koja je namijenjena za smještaj vozila, palubu za putnike, sunčalište i kormilarnicu. Pogon mu je hibridni: dizel motor s mogućnošću pogona na baterije. Plovilo je namijenjeno prijevozu privatnih automobila, kao i kombija, buseva, kamiona i prikolica. Kapacitet mu je 130 automobila ili 22 kamiona s prikolicom na glavnoj palubi i 40 automobila u potpalublju. Potpalublju se može prići s glavne palube preko dvije rampe, jedna od kojih je na krmenoj, a druga na pramčanoj strani. Rampe se pokreću hidraulički kako bi se glavna paluba u potpunosti mogla iskoristiti za parking. Na krmenom i pramčanom dijelu plovila nalaze se hidrauličke rampe preko kojih se vozila i putnici mogu nesmetano ukrcavati i iskrcavati. Plovilo može prevoziti do 600 putnika, a za posadu do 12 osoba osiguran je smještaj dok su na dužnosti.

## 2.2. Računalni model strukture

Računalni model strukture cijelog broda napravljen je u programu Rhinoceros 7.0 i prikazan na slici 2.2.1. Uzdužni presjek računalnog modela prikazan je na slici 2.2.2, a poprečni presjek na slici 2.2.3. Struktura ispod glavne palube prikazana je na slici 2.2.4. Struktura koja je relevantna za ovu analizu nalazi se unutar  $0,4L$  po sredini broda.

Materijali korišteni na ovom brodu su obični brodograđevni čelik i brodograđevni čelik povišene čvrstoće (kvaliteta AH36). Debljine limova kreću se od 6 mm za opločenje nadgrađa do 14 mm za ojačanja na poprečnim nosačima ispod glavne palube. Za brodograđevne čelike Youngov modul iznosi  $206000 \text{ N/mm}^2$  i Poissonov koeficijent iznosi 0,3. [2]

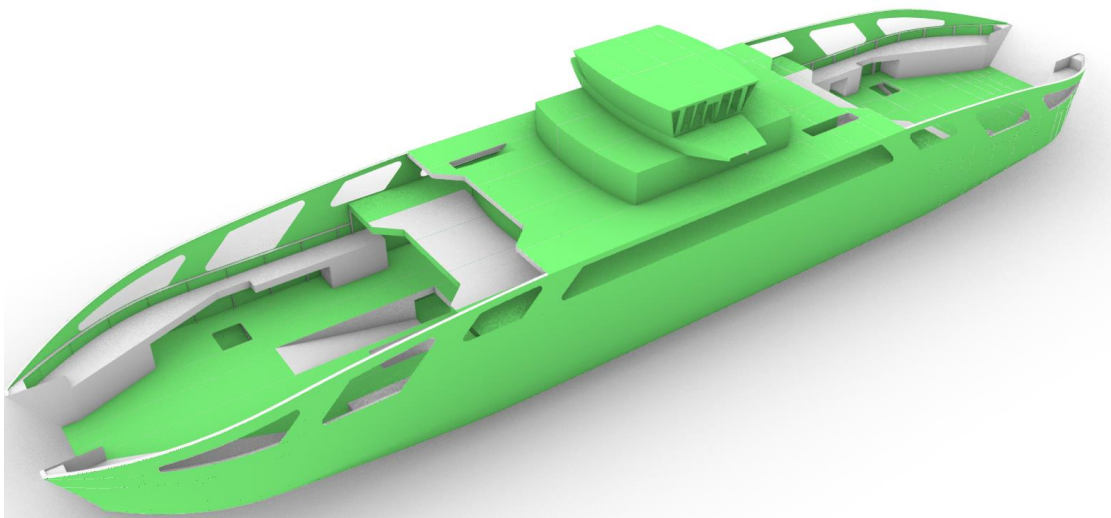

Slika 2.2.1 - Računalni model strukture cijelog broda

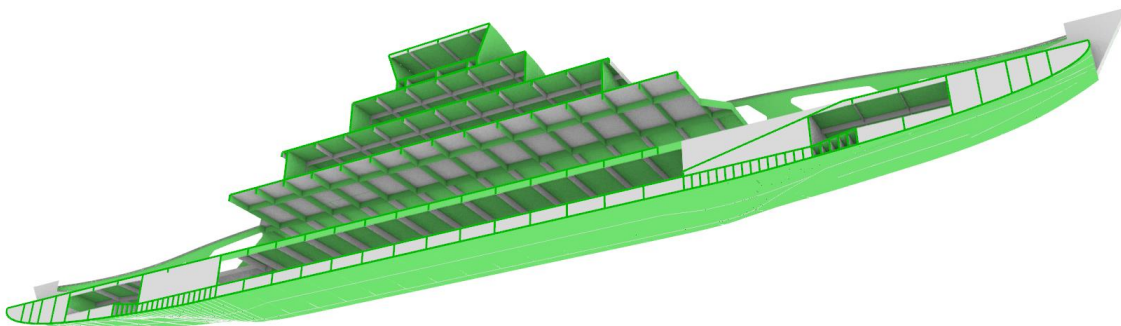

Slika 2.2.2 - Uzdužni presjek računalnog modela

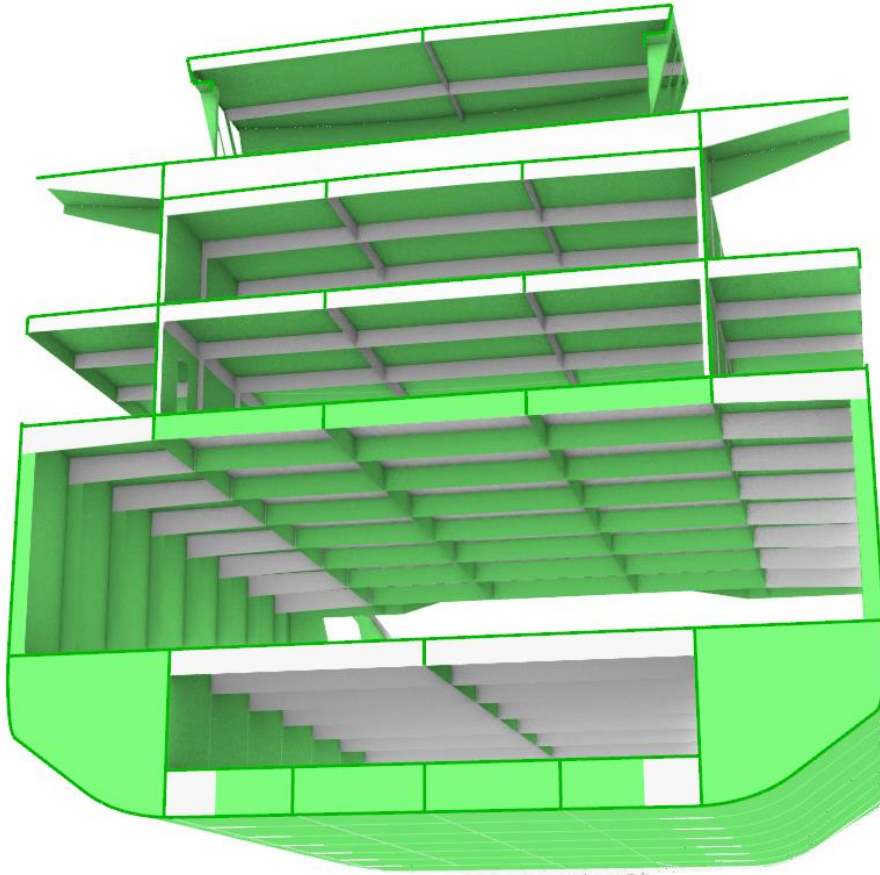

*Slika 2.2.3 - Poprečni presjek računalnog modela*

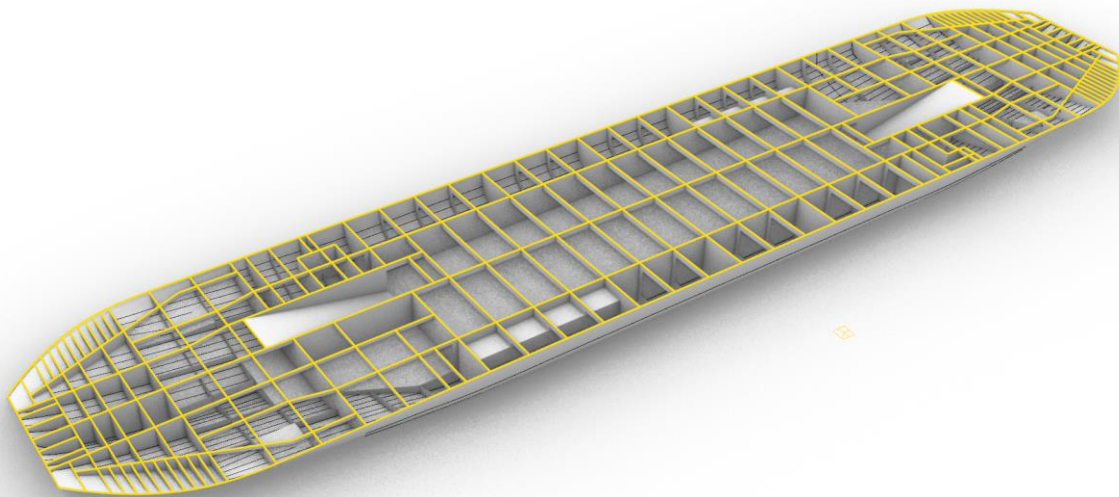

*Slika 2.2.4 - Računalni model strukture ispod glavne palube*

Specifičnost trajekata su otvorene palube za smještaj vozila s podiznim rampama sa prednje i stražnje strane broda zbog bolje protočnosti vozila. Iz istog razloga na palubama nema poprečnih pregrada te je zbog toga potrebno posebnu pažnju posvetiti opasnosti od izvijanja.

Trajekt je izrađen većinom uzdužnim načinom gradnje. Osnovni strukturni elementi uključuju strukturu koja se uzdužno prostire po većem dijelu broda: hrptenica, kobilica, uzdužne pregrade, uzdužnjaci dna, uzdužnjaci paluba, podveze i bočni nosači. Poprečni elementi strukture su rebrenice, poprečne okvire i poprečne pregrade. Poprečni sustav gradnje korišten je iznad putničke palube, gdje se mogu primijetiti i upore kojih na donjim palubama nema kako bi se povećala površina za skladištenje tereta i olakšao promet vozila po brodu.

S obzirom na način krcanja, trajekti imaju više sustavno težište u odnosu na ostale tipove brodova te je potrebno osigurati veći početni stabilitet. Na palubama nema pregrada te se treba uračunati i mogućnost naplavlivanja što stvara velike slobodne površine koje dodatno ugrožavaju stabilitet broda.



### 3. Dimenzioniranje strukture po pravilima i propisima klasifikacijskog društva

Detaljni proračun po pravilima Hrvatskog registra brodova (u daljnjem tekstu HRB) nalazi se u dodatku A ovog rada, dok su osnovne formule i krajnji rezultati obuhvaćeni proračunom prikazani u ovom poglavlju. Obostrano ukrcajni trajekt o kojem je riječ u ovom radu građen je većinski uzdužnim sustavom gradnje; poprečnim sustavom gradnje građena je samo vanjska oplata nadgrađa iznad palube za putnike. Sve palube i vanjska oplata ispod palube za putnike izvedene su uzdužnim sustavom gradnje.

Uzdužnu čvrstoću broda osiguravaju uzdužni konstrukcijski elementi koji se neprekinuto protežu duž broda: kobilica, hrptenica, bočni uzdužni nosači, bočne proveze, palubne proveze i podveze, oplata dna, neprekinuta oplata paluba, uzdužne pregrade, oplata pokrova dvodna i dijelom oplata boka u zonama udaljenima od neutralne osi. [3]

Prvi korak ka postizanju zadovoljavajuće uzdužne čvrstoće broda je pravilno dimenzioniranje konstrukcijskih elemenata po pravilima nekog klasifikacijskog društva, u ovom slučaju HRB-a. Klasifikacijska društva uz razvoj tehničke regulative razvijaju i prikladne računalne sustave za analizu brodskih konstrukcija po pravilima kojima se projektanti koriste u svakodnevnom radu. Tako će, primjerice, u ovom radu biti korišten MARS 2000, sustav koji je razvilo klasifikacijsko društvo Bureau Veritas.

Na slici 2.1.1 u prethodnom poglavlju prikazan je preliminarni nacrt glavnog rebra. Taj je nacrt korišten i za izračun momenta inercije glavnog rebra te su zbog jednostavnijeg računa umjesto bulb profila korištene trake s jednakim otpornim momentom, kako je prikazano u tablicama u prilogu B. Sve formule koje se nalaze u ovom poglavlju referiraju se na pravila i propise HRB-a. [4]

### 3.1. Opterećenja brodske konstrukcije

Opterećenje na izloženim palubama:

$$p_D = p_0 \cdot \frac{20 \cdot d}{(10+z-d) \cdot D} \cdot C_a, [\text{kN/m}^2], \quad (3.1)$$

gdje je:

$p_0$  – osnovno vanjsko opterećenje na element strukture (engl. basic external load)

$d$  – gaz broda na konstrukcijskoj vodnoj liniji

$z$  – visina elementa

$D$  – visina broda

$C_a$  – čimbenik koji ovisi o uzdužnom položaju elementa

Tablica 3.1 prikazuje opterećenja na izloženim palubama. U tablici 3.2 prikazana su minimalna opterećenja palube čvrstoće. Tablica 3.3 prikazuje opterećenja bočnih elemenata. Sva su opterećenja izražena u  $\text{kN/m}^2$ .

Tablica 3.1 - Opterećenja na izloženim palubama, HRB 3.2.1

<b>Opterećenje palube</b>	<b>[kN/m<sup>2</sup>]</b>
za putnike	11.56
sunčalište	9.91
kormilarnica	8.35
<b>Opterećenje sponja</b>	
za putnike	8.67
sunčalište	7.43
kormilarnica	6.26
<b>Opterećenje profila</b>	
za putnike	6.93
sunčalište	5.95
kormilarnica	5.01

Tablica 3.12 - Minimalno opterećenje palube čvrstoće, HRB 3.2.1.2

Opterećenje palube	16
Opterećenje sponja	12
Opterećenje profila	9.6

Opterećenje na bočne i pramčane elemente razlikuje se ovisno o visini pojedinog elementa. Za bočne i pramčane elemente koji se nalaze ispod konstrukcijske vodne linije opterećenje se računa prema formuli:

$$p_s = 10(d - z) + p_0 \cdot C_F \left(1 + \frac{z}{d}\right), \text{ [kN/m}^2\text{];} \quad (3.2)$$

Za bočne i pramčane elemente koji se nalaze iznad konstrukcijske vodne linije opterećenje se računa prema formuli:

$$p_s = p_0 \cdot C_F \frac{20}{10+z-d}, \text{ [kN/m}^2\text{];} \quad (3.3)$$

gdje je:  $C_F$  – faktor koji ovisi o uzdužnom položaju elementa

Opterećenje uzvoja iznosi 38.62 kN/m<sup>2</sup>.

Opterećenje na oplatu dna računa se po sljedećoj formuli:

$$p_B = 10 \cdot d + p_0 \cdot C_F, \text{ [kN/m}^2\text{]}, \quad (3.4)$$

i iznosi 39.84 kN/m<sup>2</sup>.

Tablica 3.3 - Opterećenja bočnih elemenata, HRB 3.2.2

	Opločenje boka	Bočne ukrepe	Uzdužnjaci boka
između pokrova dvodna i glavne palube	34.36	29.91	28.64
između glavne palube i palube kaštela	25.59	23.37	19.19
između palube kaštela i palube za putnike	20.61	19.15	15.46

Tablica 3.4 prikazuje opterećenja paluba nadgrađa, dok tablica 3.5 prikazuje opterećenja paluba kućica. Tablica 3.6 prikazuje opterećenja paluba teretom i paluba za smještaj. Sve vrijednosti opterećenja izražene su u  $\text{kN/m}^2$ .

Tablica 3.4 - Opterećenja paluba nadgrađa, HRB 3.2.5

Paluba kaštela	16
Paluba za putnike	5.78
Sunčalište	4.96

Tablica 3.5 - Opterećenja paluba kućica, HRB 3.2.5

Opločenje	4.17
Ukrepe	2.50
Profili	2.50

Tablica 3.6 - Opterećenje paluba teretom i paluba za smještaj, HRB 3.3

Opterećenje teretom	39.12
Opterećenje dvodna	5.11
Opterećenje nastambi	7.21
Opterećenje strojarnice	16.47

U tablici 3.7 prikazana su opterećenja tankova, čije su vrijednosti izražene u  $\text{kN/m}^2$ .

Tablica 3.7 - Opterećenja tankova, HRB 3.4

Opterećenja punih tankova	p1 slatka voda	31.74
	p1 protuljuljni tank	30.22
	p2 slatka voda	10.91
	p2 protuljuljni tank	9.44
Opterećenja djelomično ispunjenih tankova	p <sub>dx</sub>	27.33

Na nacrtu glavnog rebra (slika 2.1.1) prikazan je protuljuljni tank. Tank slatke vode proteže se od petnaestog do trideset i petog rebra na pramčanoj strani i na krmenoj strani broda, kako je vidljivo iz općeg plana broda (slika 2.1.2).

### 3.2. Dimenzioniranje oplata

Za brodove duže od 90 m oplata dna u sredini broda (srednjih 40% dužine) ne smije biti tanja od sljedećih vrijednosti:

$$t_1 = 18,3 \cdot n_1 \cdot s \cdot \sqrt{\frac{p_B}{\sigma_a}} + t_k, \text{ [mm]}, \quad (3.5)$$

$$t_2 = 1,21 \cdot s \cdot \sqrt{p_B \cdot k} + t_k, \text{ [mm]}, \quad (3.6)$$

gdje je:

$$\sigma_a = \sqrt{\sigma_{dop}^2 - 3 \cdot \tau_L^2} - 0,89 \cdot \sigma_L, \text{ [N/mm}^2\text{]};$$

$\sigma_a$  – opterećenje izraženo gornjom jednadžbom

$\sigma_L$  – najveće normalno opterećenje uzdužnog nosača

$\sigma_{dop}$  – dopušteno opterećenje

$$\sigma_L = \frac{120}{k} \text{ [N/mm}^2\text{]} \text{ za brodove duljine veće od 90 m;}$$

$k$  – faktor materijala (za obični brodograđevni čelik iznosi 1, za čelik povišene čvrstoće kvalitete AH36 iznosi 0,72)

$\tau_L$  – najveća projektana smična sila uslijed uzdužnog savijanja nosača

$s$  – udaljenost među profilima

Za brodove koji zadovoljavaju uvjete uzdužne čvrstoće oplata dna ne smije biti tanja od:

$$t_{krit} = c_1 \cdot 2,32 \cdot s \cdot \sqrt{\sigma_L} + t_k, \text{ [mm]}, \quad (3.7)$$

gdje je:

$t_k$  – dodatak za koroziju

$c_1$  – faktor; iznosi 0,5 za uzdužno orebrenje

Usvojena debljina oplata dna iznosi 10,5 mm. Debljina kobilice i dokobiličnog voja gredne kobilice ne smije biti manja od:

$$t_{KB} = t + 2$$

gdje je  $t$  debljina opločenja dna u mm. Usvojena debljina kobilice iznosi 11 mm.

Za brodove dulje od 90 m opločenje boka ne smije biti manje od:

$$t_1 = 18,3 \cdot n_1 \cdot s \cdot \sqrt{\frac{p_s}{\sigma_a}} + t_k, \text{ [mm]}, \quad (3.8)$$

$$t_2 = 1,21 \cdot s \cdot \sqrt{p_s \cdot k} + t_k, \text{ [mm]}, \quad (3.9)$$

gdje je:

$$\sigma_a = \sqrt{\sigma_{dop}^2 - 3 \cdot \tau_L^2} - 0,89 \cdot \sigma_{LS}, \text{ [N/mm}^2\text{]};$$

$\sigma_a$  – opterećenje izraženo gornjom jednačbom

$\sigma_L$  – najveće normalno opterećenje uzdužnog nosača

$\sigma_{dop}$  – dopušteno opterećenje

$$\sigma_{LS} = 0,76 \cdot \sigma_L$$

$$\sigma_L = \frac{120}{k} \text{ [N/mm}^2\text{]} \text{ for } L \geq 90 \text{ m};$$

$$\tau_L = \frac{55}{k} \text{ [N/mm}^2\text{]}.$$

Usvojena debljina opločenja boka iznosi 8 mm.

Širina završnog voja ne smije biti manja od:

$$b = 800 + 5 \cdot L, \text{ [mm]},$$

ni veća od 1800 mm. Usvojena širina završnog voja iznosi 1265 mm.

### 3.3. Uzdužna čvrstoća

Zbog razlike u raspodjeli uzgona i težina po dužini broda dolazi do pojave smičnih sila i momenata savijanja. Kako te sile i momenti ne bi uzrokovali pucanje konstrukcije ili izvijanje, potrebno je pravilno dimenzionirati elemente strukture kako bi se postigao dovoljan otporni moment. S obzirom da je dužina broda puno veća od njegove širine, u ovom proračunu obrađuje se samo uzdužna čvrstoća broda, samo za slučaj najnepovoljnijeg stanja krcanja.

Standardna stanja krcanja koja se ispituju uključuju varijaciju krcanja (maksimalno nakrcani brod, brod bez tereta i djelomično nakrcani brod) kao i varijaciju provijanata (10, 50 i 100 posto provijanata). Najnepovoljnije stanje krcanja po rezultatima iščitanim iz knjige trima i stabiliteta je LC02: maksimalno nakrcani brod sa 100% provijanata.

Smične sile i momenti savijanja na mirnoj vodi iščitan su iz izvotka knjige trima i stabiliteta. Prikazani su na slici 3.3.1 i njihove vrijednosti navedene su u tablici 3.3.1.

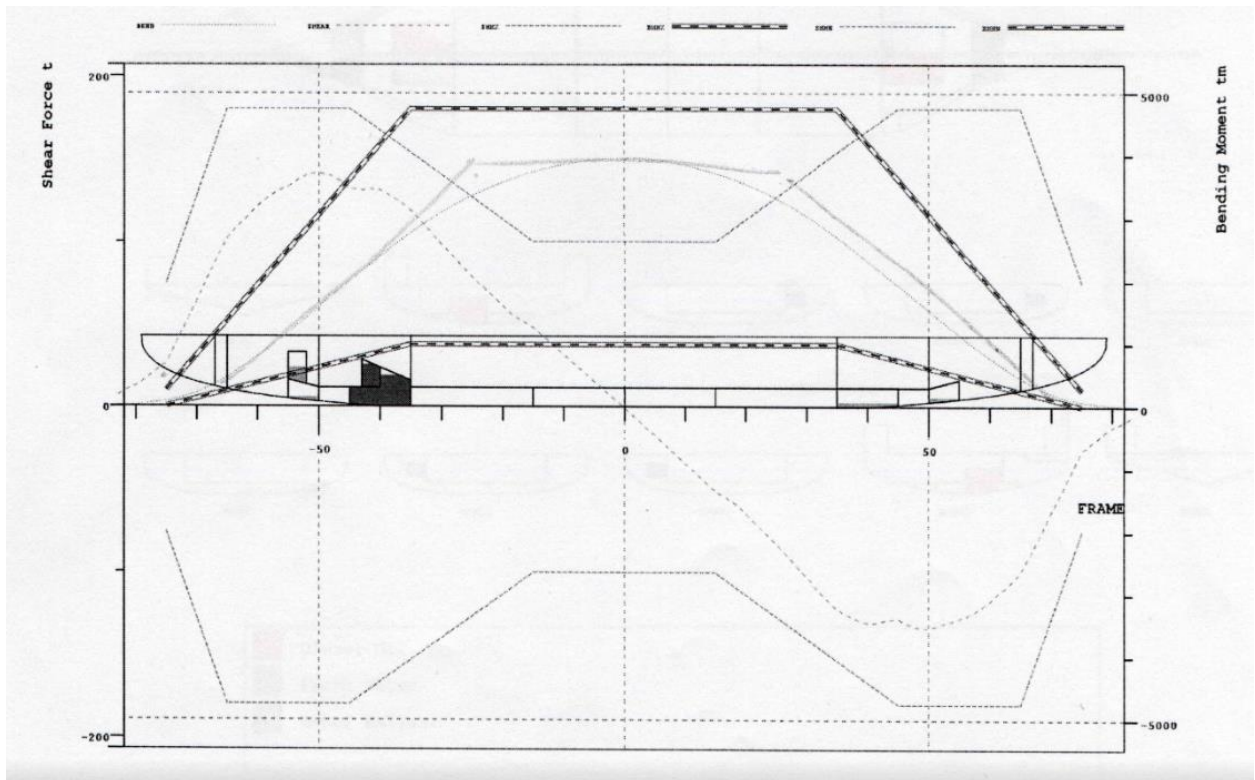

Slika 3.3.1 - Smične sile i momenti savijanja na mirnoj vodi

Tablica 3.3.1 - Smične sile i momenti savijanja na mirnoj vodi

	t	kN
Pozitivna smična sila na mirnoj vodi	141	1382.74
Negativna smična sila na mirnoj vodi	-141	-1382.74
	tm	kNm
Moment savijanja pri pregibu	3955	38785.30
Moment savijanja pri progibu	-3955	-38785.30

Zbog gibanja mora dolazi do različite razdiobe uzgona i težina te se zbog toga računaju momenti savijanja i smične sile na valovima. Vrijednosti istih računaju prema pravilima i propisima HRB-a po sljedećoj formuli:

a) Pregibno stanje

$$M_w = +190M \cdot C_w \cdot L^2 \cdot B \cdot C_b \cdot 10^{-3}, [\text{kNm}]; \quad (3.10)$$

$$F_w = +30 F_1 \cdot C_w \cdot L \cdot B \cdot (C_b + 0,7) \cdot 10^{-2}, [\text{kN}]; \quad (3.11)$$

b) Progibno stanje

$$M_w = -110M \cdot C_w \cdot L^2 \cdot B \cdot (C_b + 0,7) \cdot 10^{-3}, [\text{kNm}] \quad (3.12)$$

$$F_w = -30 F_2 \cdot C_w \cdot L \cdot B \cdot (C_b + 0,7) \cdot 10^{-2}, [\text{kN}] \quad (3.13)$$

gdje je:

$M, F_1, F_2$  – faktori koji ovise o uzdužnom položaju elementa

$$M(x) = \begin{cases} 2,5 \cdot \frac{x}{L}, & \text{for } \frac{x}{L} < 0,40 \\ 1,0, & \text{for } 0,4 \leq \frac{x}{L} \leq 0,65, \\ \frac{1-\frac{x}{L}}{0,35}, & \text{for } \frac{x}{L} > 0,65 \end{cases}$$

$$C_w = 10,75 - \left(\frac{300-L}{100}\right)^{1,5}$$

$L$  – dužina broda

$B$  – širina broda

$C_b$  - koeficijent punoće istisnine



S obzirom da je plovidba trajekta ograničena na hrvatske vode (područje 5), moment savijanja može se umanjiti za 30%. Usvojeni moment savijanja na valovima za pregibno stanje iznosi 106500,4 kNm, a za progibno -133592,6 kNm. Smična sila na valovima iznosi  $\pm 3930,35$  kN.

Moment inercije glavnog rebra i modul presjeka izračunati su pomoću programa Rhinoceros 7.0, kako je prikazano na slici 3.3.2. Analizom koja će biti pobliže objašnjena u kasnijim poglavljima utvrđeno je koji dio strukture ulazi u uzdužnu čvrstoću te je za taj dio strukture izračunata neutralna os, moment inercije i otporni momenti. Njihove vrijednosti navedene su u tablici 3.3.2.

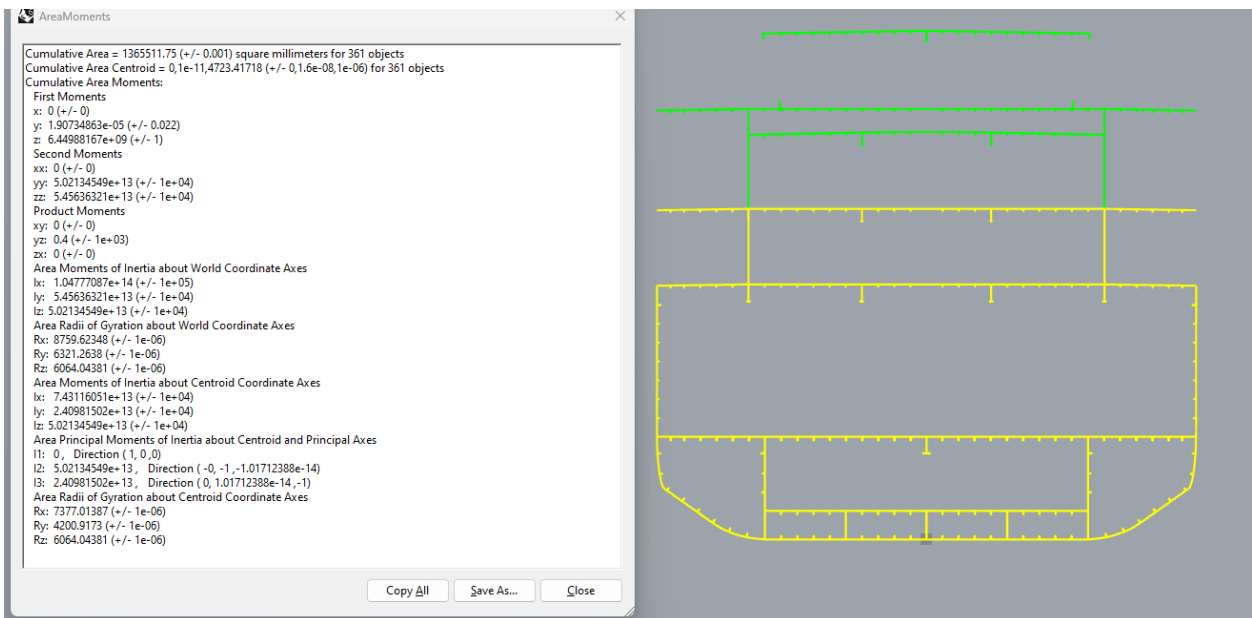

Slika 3.3.2 - Moment inercije i otporni moment glavnog rebra

Tablica 3.3.2 - Moment inercije i otporni moment glavnog rebra

Površina presjeka uzdužnih elemenata	13655.12	cm <sup>4</sup>
Horizontalna udaljenost od centralne linije do vertikalne neutralne linije, Y <sub>n</sub>	0	m
Vertikalna udaljenost od osnove do horizontalne neutralne linije, Z <sub>n</sub>	4.723	m
Vertikalni moment inercije, I <sub>y</sub>	24.1	m <sup>4</sup>
Horizontalni moment inercije, I <sub>z</sub>	50.21	m <sup>4</sup>
Moment otpora dna, W <sub>D</sub>	3.65	m <sup>3</sup>
Moment otpora palube, W <sub>P</sub>	1.76	m <sup>3</sup>
Statički moment površine presjeka elemenata uzdužne čvrstoće oko neutralne osi	6.45	m <sup>3</sup>
Omjer momenta inercije i statičkog momenta površine	3.74	m

Otporni moment ne smije biti manji od vrijednosti dobivene formulom:

$$W = \frac{|M_s + M_w|}{\sigma} \cdot 10^3, [\text{cm}^3], \quad (3.14)$$

gdje je:

$\sigma$  - dopušteno normalno naprezanje [N/mm];

$$\text{za } L \geq 90, \sigma(x) = \begin{cases} \left(0,5 + \frac{5}{3} \cdot \frac{x}{L}\right) \cdot \frac{18,5\sqrt{L}}{k}, & \text{for } \frac{x}{L} < 0,3 \\ \frac{175}{k}, & \text{for } 0,3 \leq \frac{x}{L} \leq 0,7 \\ \frac{5}{3} \cdot \left(1,3 - \frac{x}{L}\right) \cdot \frac{18,5\sqrt{L}}{k}, & \text{for } \frac{x}{L} > 0,7 \end{cases} ;$$

$k = 1,0$  za običan brodograđevni čelik

$k = 0,72$  for za čelik povišene čvrstoće kome je  $ReH = 355 \text{ N/mm}^2$  (AH36)

$$\sigma = \frac{175}{k} = 243,06 \text{ N/mm}$$

$$W_{min, \text{progib}} = \frac{|M_s + M_w|}{\sigma} \cdot 10^3 = 0,598 \text{ m}^3$$

$$W_{min, \text{pregib}} = \frac{|M_s + M_w|}{\sigma} \cdot 10^3 = 0,39 \text{ m}^3$$

Minimalni otporni moment određen je izrazom:

$$W_{min, reduced} = 80\% [C_w \cdot L^2 \cdot B \cdot (C_b + 0,7) \cdot k] = 0,99 \text{ m}^3 \quad (3.15)$$

Po rezultatima iz tablice 3.3.2 vidljivo je da su i otporni moment dna i otporni moment palube veći od minimalne vrijednosti propisane pravilima i propisima.

Minimalni moment inercije određen je izrazom:

$$I_{min} = 3 \cdot \frac{L}{k} \cdot W_{min}, [\text{cm}^4] = 3,86 \text{ m}^4$$

Moment inercije također zadovoljava zadani kriterij, to jest veći je od minimalnog (tablica 3.3.2).

### 3.4. Izvijanje

Potrebno je obratiti pozornost na lokalne kriterije čvrstoće na izvijanje. Normalno tlačno naprežanje u limovima određeno je izrazom:

$$\sigma_E = 0,9 mE \left( \frac{t_b}{1000 \cdot b} \right)^2, \text{ [N/mm}^2\text{]}, \quad (3.16)$$

gdje je:

$E$  – modul elastčnosti materijala

$t_b$  – debljina mreže oploćenja

$b$  – kraća stranica promatranog panela

Slika 3.4.1 prikazuje numeraciju panela za koje je ispitano zadovoljavaju li lokalne kriterije čvrstoće na izvijanje. Za detaljni tablični prikaz pogledati dodatak C.

Normalno kritično naprežanje ( $\sigma_c$ ) može se izjednačiti s normalnim tlačnim naprežanjem u limovima ( $\sigma_E$ ) ukoliko je:

$$\sigma_E \leq \frac{\sigma_F}{2} \quad (3.17)$$

gdje je:

$\sigma_F$  – granica razvlačenja, N/mm<sup>2</sup>

$\sigma_F = 235$  N/mm<sup>2</sup> za običan brodograđevni čelik

$\sigma_F = 355$  N/mm<sup>2</sup> za brodograđevni čelik povišene čvrstoće kvalitete AH36

Ukoliko izraz 3.17 nije zadovoljen, normalno kritično naprežanje ( $\sigma_c$ ) se računa prema izrazu:

$$\sigma_c = \sigma_F \left( 1 - \frac{\sigma_F}{4\sigma_E} \right) \quad (3.18)$$

Iz tablice na stranici 74 može se primijetiti da limovi na palubi za putnike i na sunčalištu nisu zadovoljili kriterije čvrstoće na izvijanje. Iz toga su razloga ispod tih paluba postavljene trake 50x10 protiv izvijanja i između njih postavljene upore.

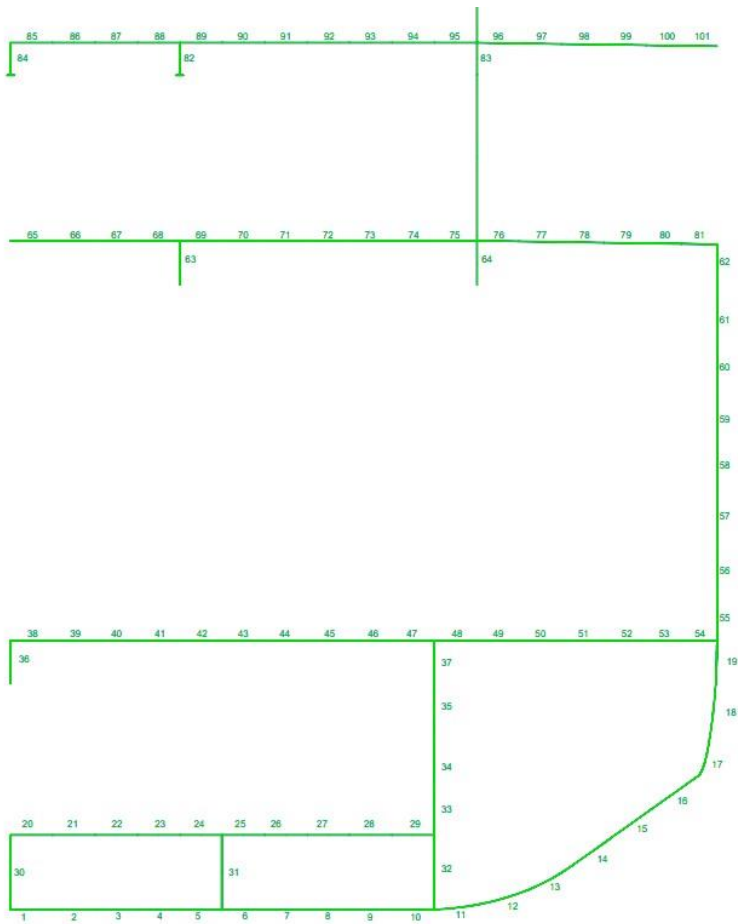

*Slika 3.4.1 - Numeracija panela za provjeru lokalnih kriterija na izvicanje*

## 4. Analiza metodom konačnih elemenata

Analiza metodom konačnih elemenata je alat za rješavanje složenih inženjerskih problema koji uključuju odziv pomorskih struktura, utjecaj tekućina, prijenos topline, vibracije i još mnogo toga. FEA se može koristiti za simulaciju ponašanja sustava pod različitim uvjetima opterećenja i okoliša te za optimizaciju njegovog dizajna i performansi.

U ovom poglavlju predstaviti će se strukturalna analiza obostrano ukrcajnog trajekta u progibnom i pregibnom stanju za najnepovoljnije stanje krcanja. Opisati će se glavne korake i izazove procesa metode konačnih elemenata, kao što su stvaranje mreže, rubni uvjeti i svojstva materijala. Analiza je podijeljena na tri dijela koji odgovaraju različitim strukturalnim konfiguracijama plovila. Prvi dio razmatra trup do glavne palube, koji je najkritičniji dio za uzdužnu čvrstoću broda. Drugi dio razmatra trup do palube za putnike, što dodaje težinu i krutost nadgrađa. Treći dio razmatra cijeli brod, uključujući kormilarnicu. Cilj trodijelne analize je utvrditi kako nadgrađe utječe na uzdužnu čvrstoću broda, te ocijeniti optimalnu konstrukciju nosača trupa.

Za analizu metodom konačnih elemenata korišten je Siemens FEMAP [5], u kojem su odrađene sve faze analize: omrežavanje i prethodna obrada, simulacija i vizualizacija rezultata.

### 4.1. Omrežavanje geometrije

Od modela cijelog broda izdvojene su površine unutar 0,4L te su prebačene u FEMAP. U ovom softveru jedan od izazova je što su vrijednosti bezdimenzionalne te je potrebno posebnu pažnju posvetiti mjernim jedinicama. Stoga je pri prebacivanju model skaliran 1000 puta kako bi udaljenost bila izražena u milimetrima. Na slici 4.1.1 prikazana je veličina korištene mreže i sama mreža (može se primijetiti da su korištena dva materijala koja se razlikuju bojom; običan brodograđevni čelik i čelik povišene čvrstoće). Veličina mreže je 300 mm. Slika 4.1.2 prikazuje detalj mreže ispod sunčališta sa navedenim korištenim postavkama. Korištene su tri vrste elemenata: plate, beam i rigid elementi. Plate elementi korišteni su za limove, beam elementi za upore, profile i trake, a rigid elementi korišteni su za postavljanje rubnih uvjeta. Na slici 4.1.3 prikazane su postavke brodograđevnog čelika povišene čvrstoće kvalitete AH36. Razlika između tog materijala i običnog brodograđevnog čelika koji se također koristi u analizi je u granici

razvlačenja, koja za običan brodograđevni čelik iznosi 235 MPa, dok za čelik povišene čvrstoće iznosi 355 MPa. Youngov modul elastičnosti za oba materijala iznosi 206 MPa, a Poissonov koeficijent 0,33.

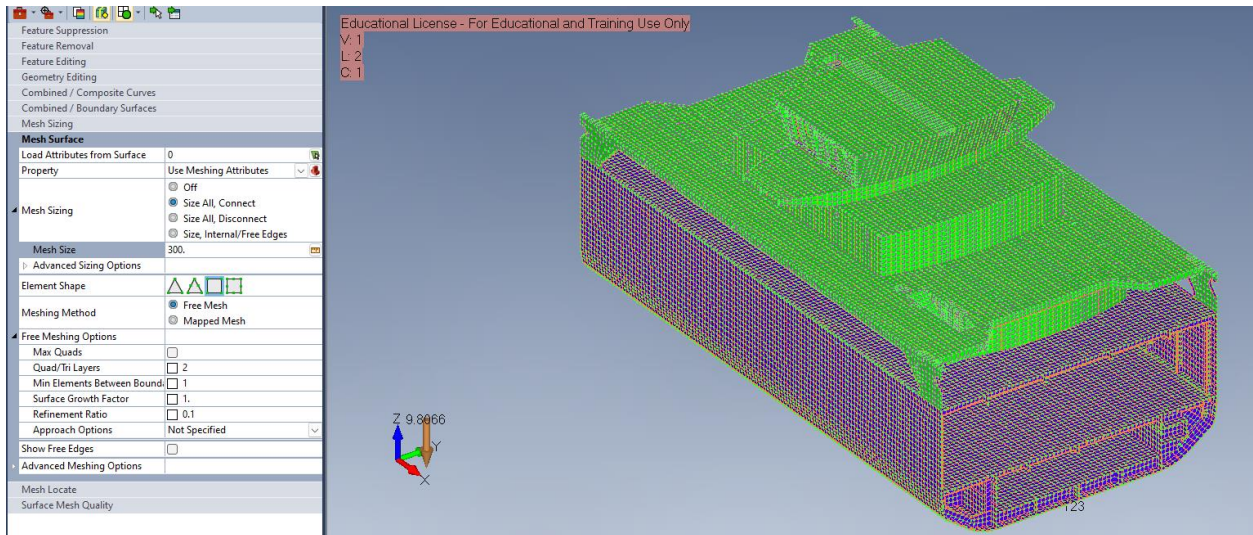

Slika 4.1.1 - Omrežena struktura

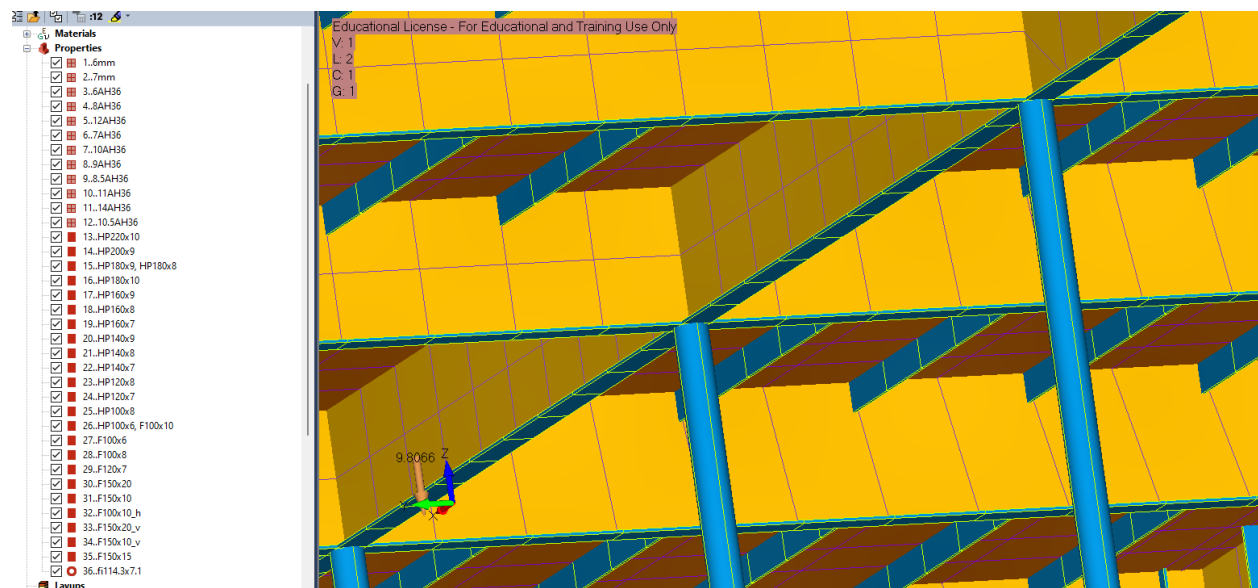

Slika 4.1.2 - Korištene postavke

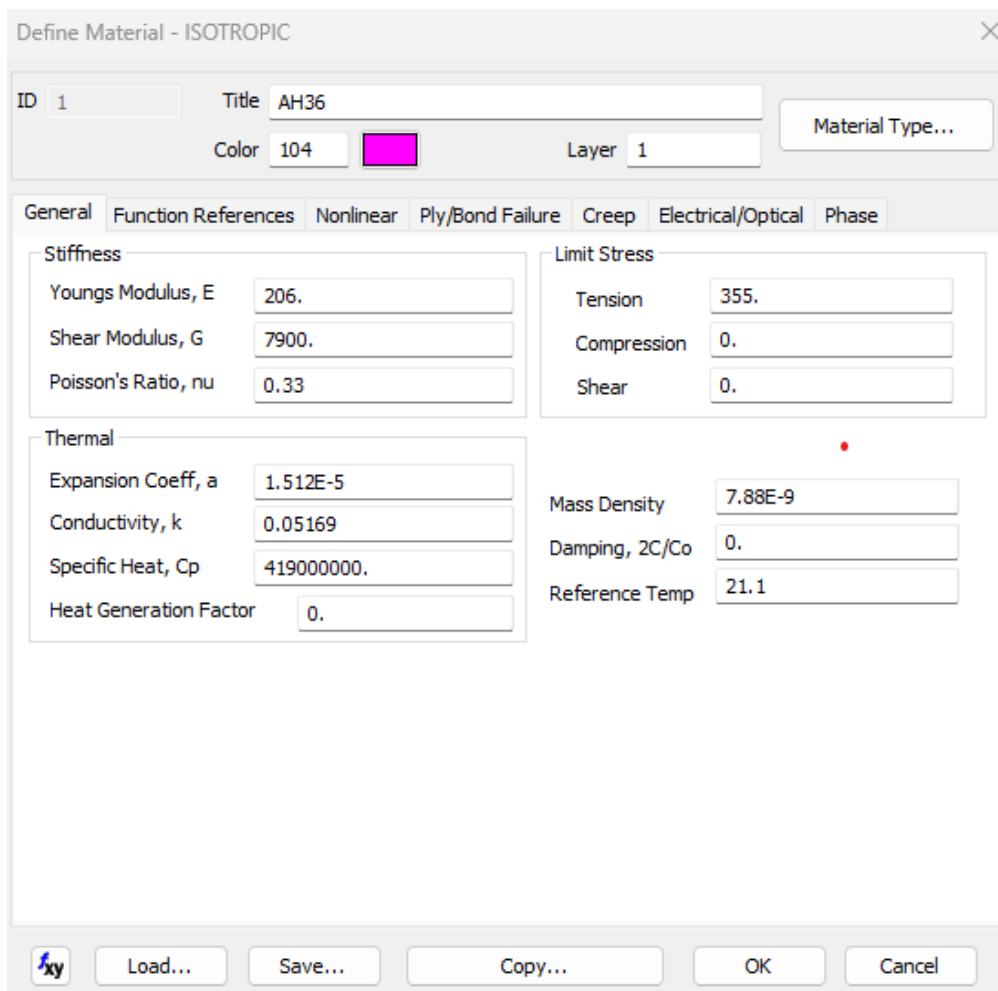

Slika 4.1.3 - Svojstva materijala definirana u FEMAPu

## 4.2. Rubni uvjeti

Opterećenje je definirano koristeći podatke iz knjige trima i stabiliteta za proračun vertikalnog momenta savijanja i vertikalne smične sile na mirnoj vodi, dok su vrijednosti vertikalnog momenta savijanja i smične sile na valovima dobivene prema pravilima i propisima HRB-a.

Sile i momenti pri progibu odnosno pregibu postavljeni su u točkama koje se nalaze na uzdužnom presjeku broda na visini neutralne osi, udaljene od glavnog rebra za 20% dužine broda. U tablici 4.2.1 prikazane su vrijednosti sila i momenata koje su korištene pri analizi.

Najnepovoljnije stanje krcanja koje se promatra u ovom slučaju je LC2 sa maksimalnim opterećenjem od tereta i 100% provijanata. Provijanti u ovom slučaju uključuju gorivo i slatku vodu, no kako se tank goriva ne nalazi unutar 0,4L na sredini broda, on nije uzet u obzir pri analizi.

Tankovi svježe vode prostiru se od 15. do 35. rebra sa svake strane broda, kako je vidljivo na općem planu (slika 2.1.2).

Tablica 4.2.1 - Vrijednosti sila i momenata

	$M_s$	$M_w$	$M$	$F_s$	$F_w$	$F$
Progib	38785.3	106500.4	145285.7	1382.74	3930.35	5313.09
Pregib	-38785.3	-133593	-172378	-1382.74	-3930.35	-5313.09
	kNm	kNm	kNm	kN	kN	kN

Na slici 4.2.1. prikazan je rubni uvjet za brod u progibu.

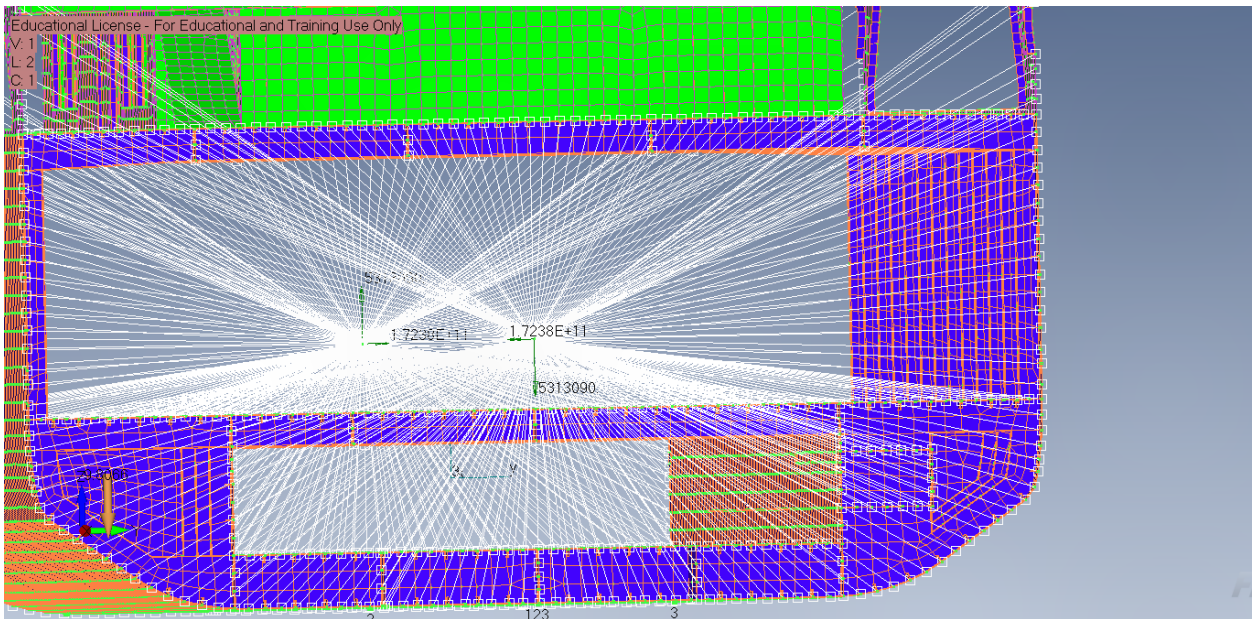

Slika 4.2.1 - Rubni uvjet za brod u progibu

Prilikom analize metodom konačnih elemenata, ograničenja su neophodna jer pomažu osigurati da su rezultati simulacije točni i reprezentiraju uvjete koje će struktura koja se analizira doživjeti u stvarnom životu. Drugim riječima, ograničenja se koriste za ograničavanje stupnjeva slobode strukture. Točna i realna primjena ograničenja ima značajan utjecaj na točnost rezultata simulacije. Ako je riječ o statičkom problemu, kao u ovom slučaju, djelovanje primijenjenih opterećenja uravnoteženo je skupom reaktivnih opterećenja tako da se konstrukcija deformira, ali ostaje statična.

U tablici 4.2.2 i na slici 4.2.2 prikazana su ograničenja koja su korištena u analizi po preporuci Bureau Veritasa. [6]



Tablica 4.2.2 - Ograničenja stupnjeva slobode

Rubni uvjeti	Translacija		
	X	Y	Z
Točka na pramčanoj strani modela	Slobodna	Ograničena	Ograničena
Točka na lijevoj strani oplata na krmenoj strani broda	Ograničena	Slobodna	Ograničena
Točka na desnoj strani oplata na krmenoj strani broda	Slobodna	Ograničena	Ograničena

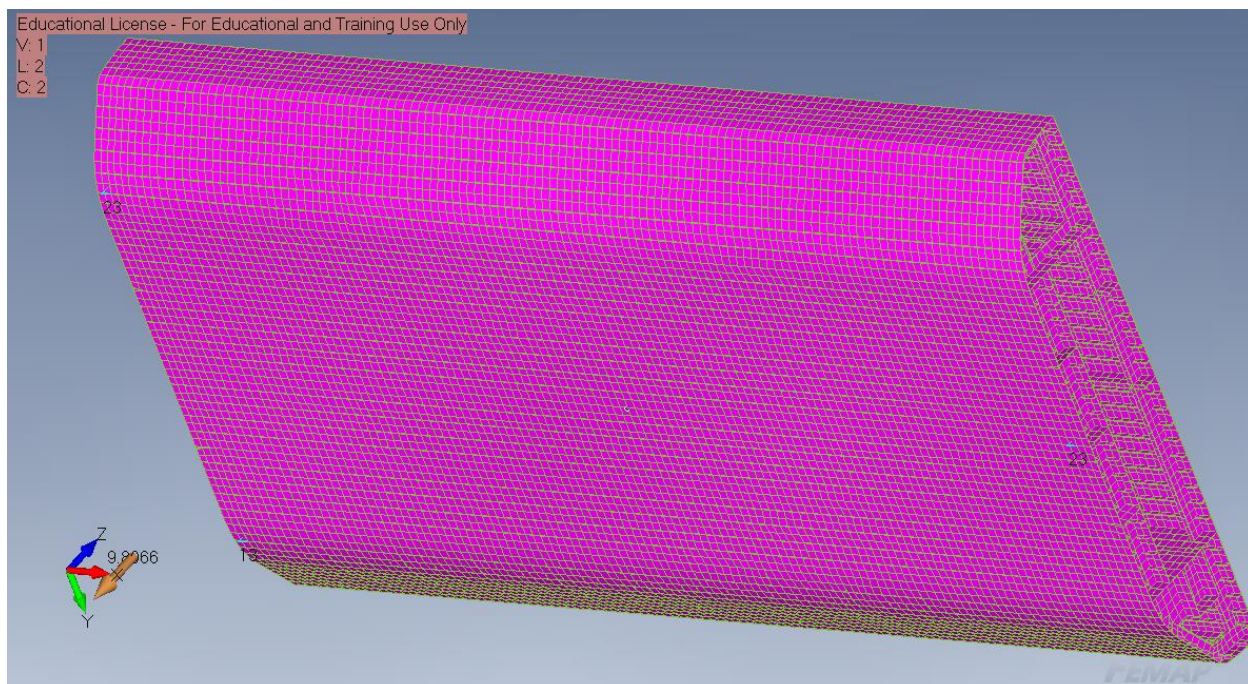

Slika 4.2.2 - Ograničenja primijenjena na modelu

### 4.3. Prikaz rezultata

Na slikama 4.3.1 - 4.3.13 prikazani su rezultati tri uzastopne analize MKE. Prva je uključivala samo strukturu do glavne palube, druga strukturu do putničke palube, a treća cjelokupnu strukturu unutar  $0,4L$  na sredini plovila. Očekivano, što je više strukture uključeno u analizu, manja su naprezanja i manje su deformacije strukture; unatoč visokim vrijednostima koje se mogu primijetiti na slici 4.3.9. One se javljaju zbog velikih otvora te bi njih bilo potrebno dodatno ukrijepiti i napraviti gušću mrežu na tom području. Ali ako se grupiraju samo elementi ispod putničke palube te se usporede rezultati s drugom analizom, može se zaključiti da i struktura iznad

putničke palube preuzima barem dio opterećenja. To pokazuju i manja maksimalna naprezanja profila koja se smanjuju s postepenim uključivanjem strukture.

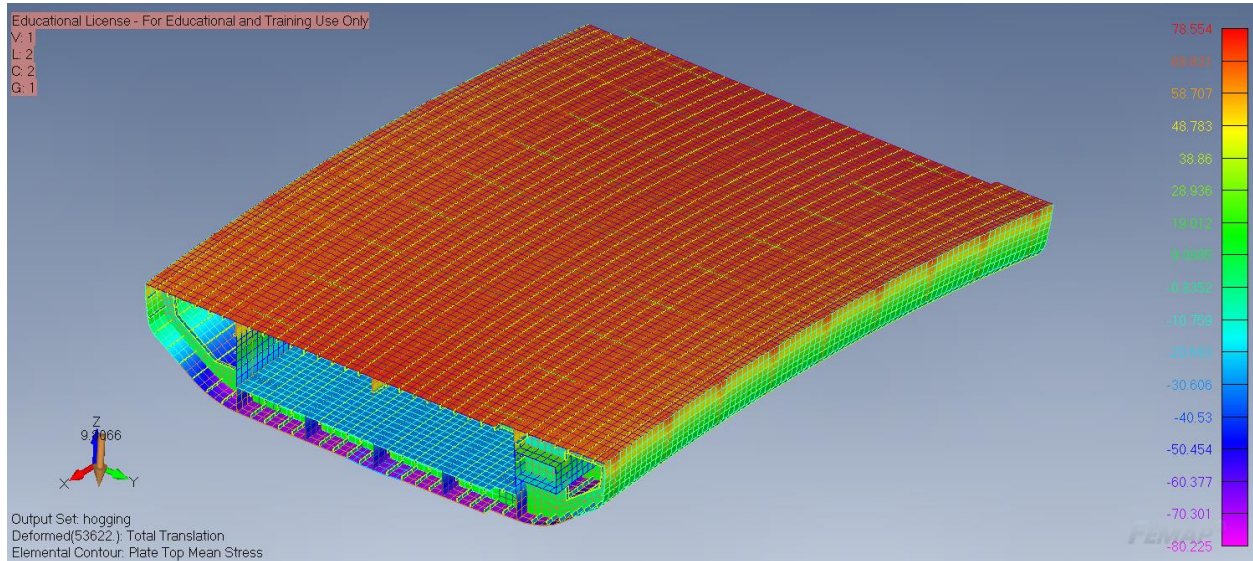

Slika 4.3.1 – Naprezanja strukture ispod glavne palube broda u pregibu

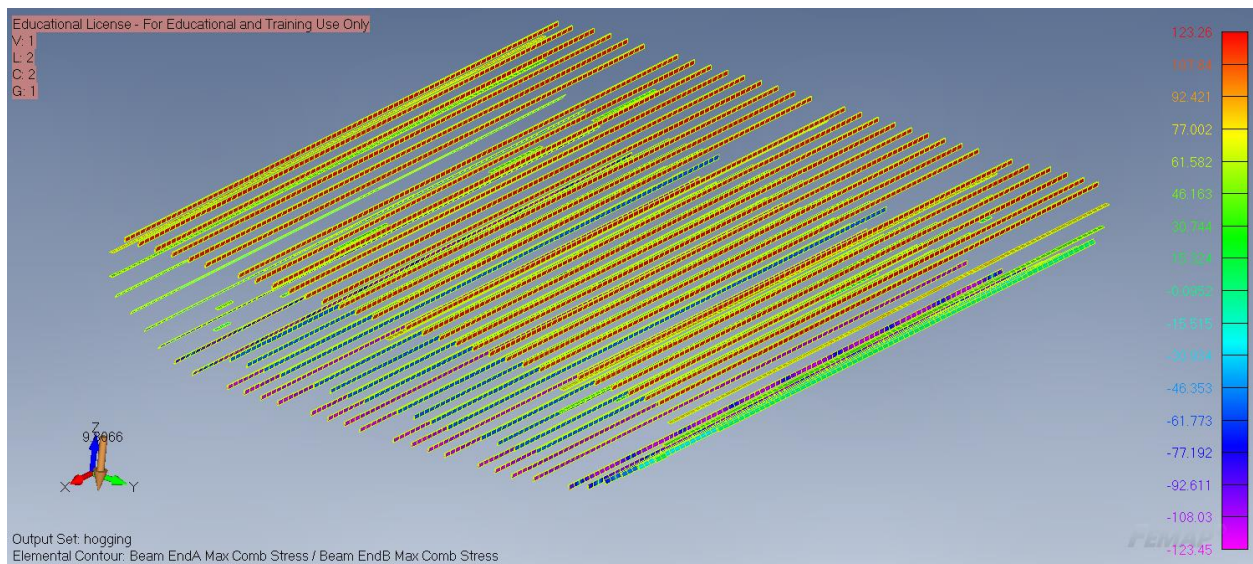

Slika 4.3.2 - Maksimalna naprezanja profila ispod glavne palube u pregibu

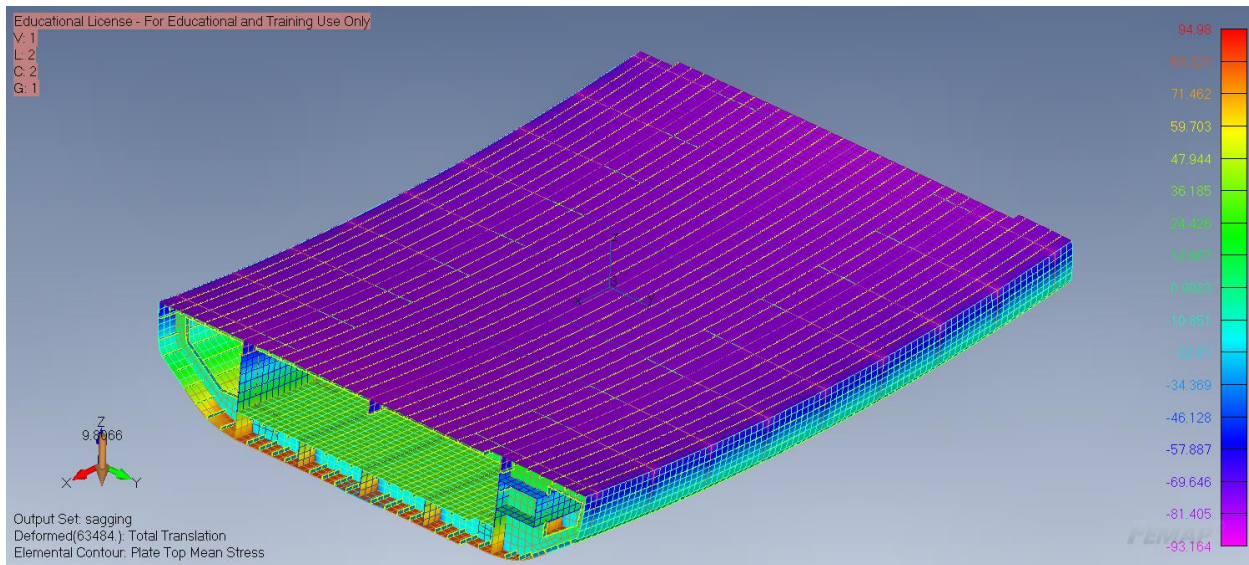

Slika 4.3.3 - Naprezanja strukture ispod glavne palube broda u progibu

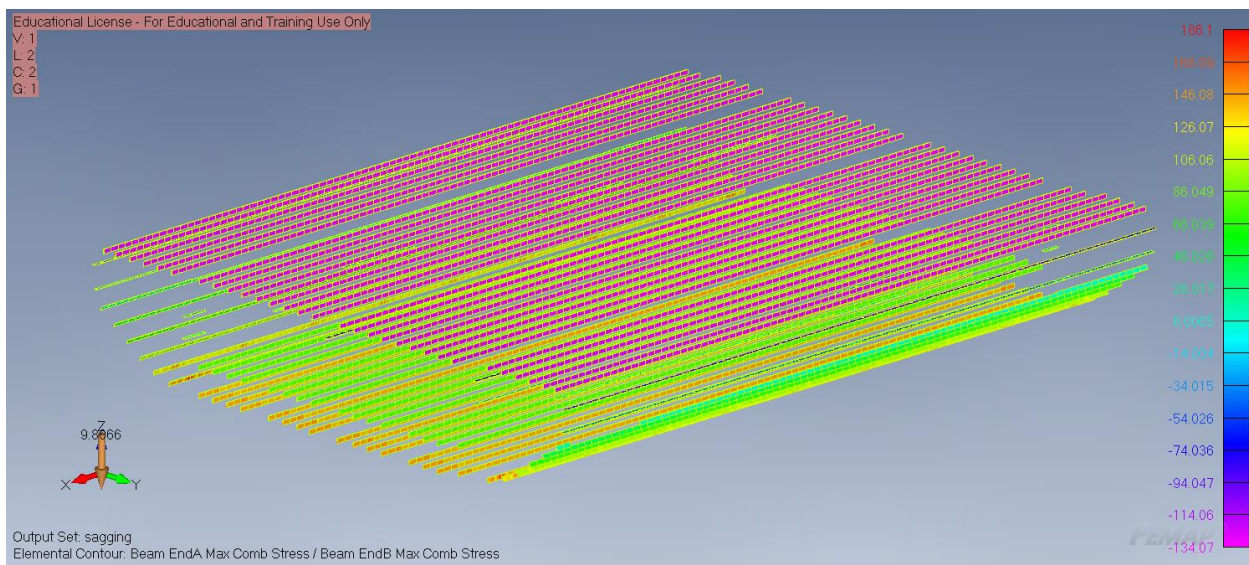

Slika 4.3.4 - Maksimalna naprezanja profila ispod glavne palube broda u progibu

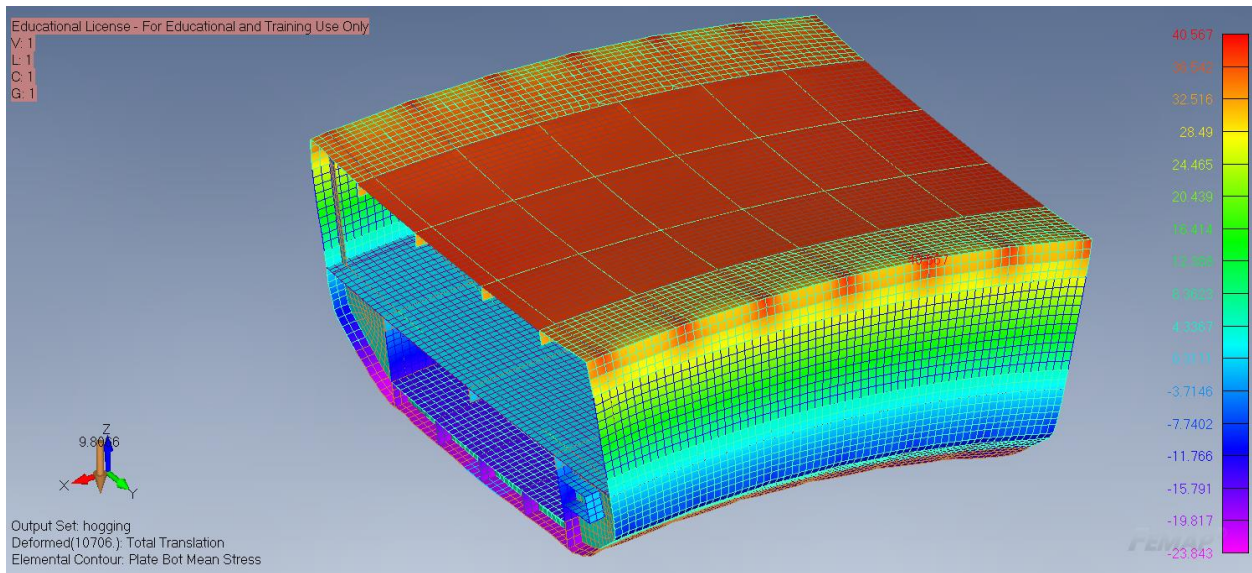

Slika 4.3.5 - Naprezanja strukture ispod palube za putnike broda u pregibu

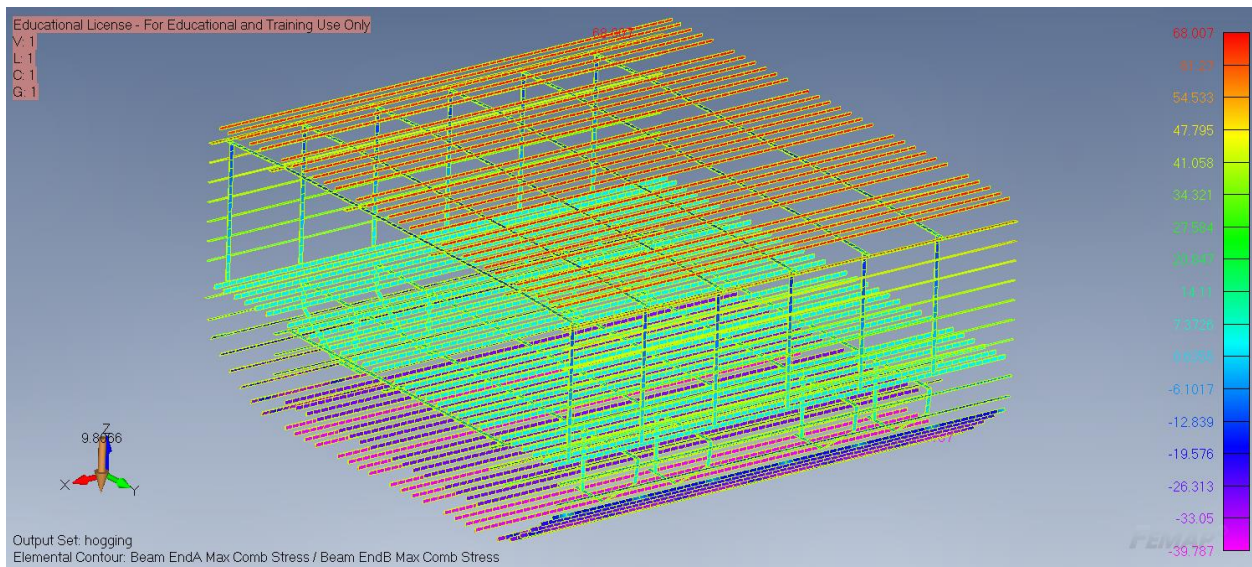

Slika 4.3.6 - Maksimalna naprezanja profila strukture ispod putničke palube broda u pregibu

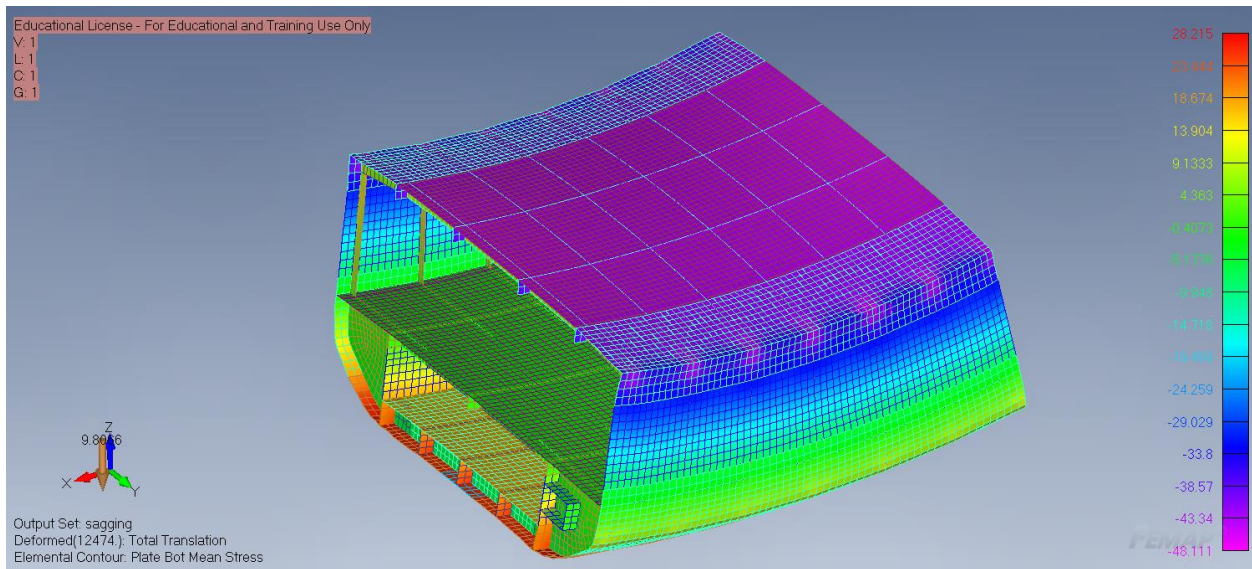

Slika 4.3.7 - Naprezanja strukture ispod putničke palube broda u progibu

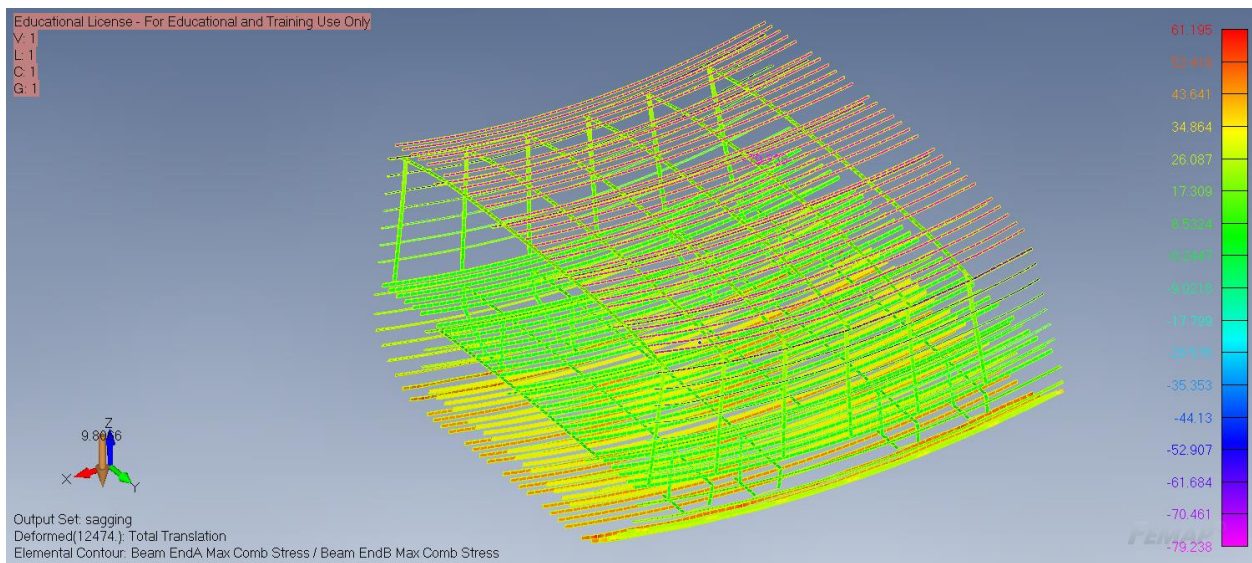

Slika 4.3.8 - Maksimalna naprezanja profila ispod putničke palube broda u progibu

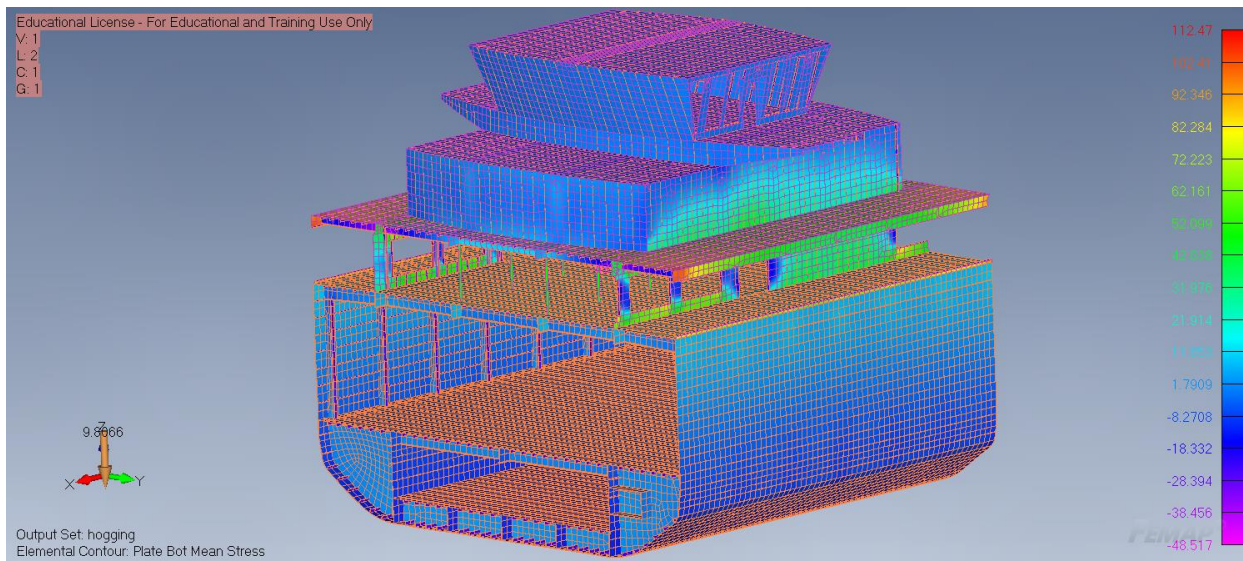

Slika 4.3.9 - Naprezanja strukture cijelog trajekta u pregibu

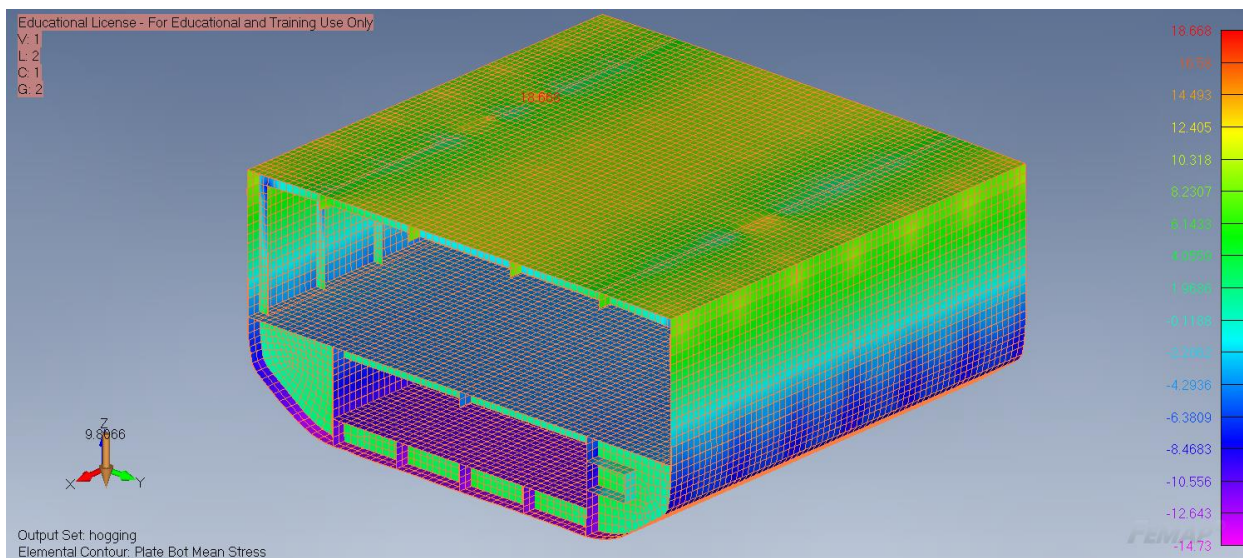

Slika 4.3.10 - Naprezanja strukture ispod putničke palube u slučaju uključenosti cijelog nadgrađa pri pregibu

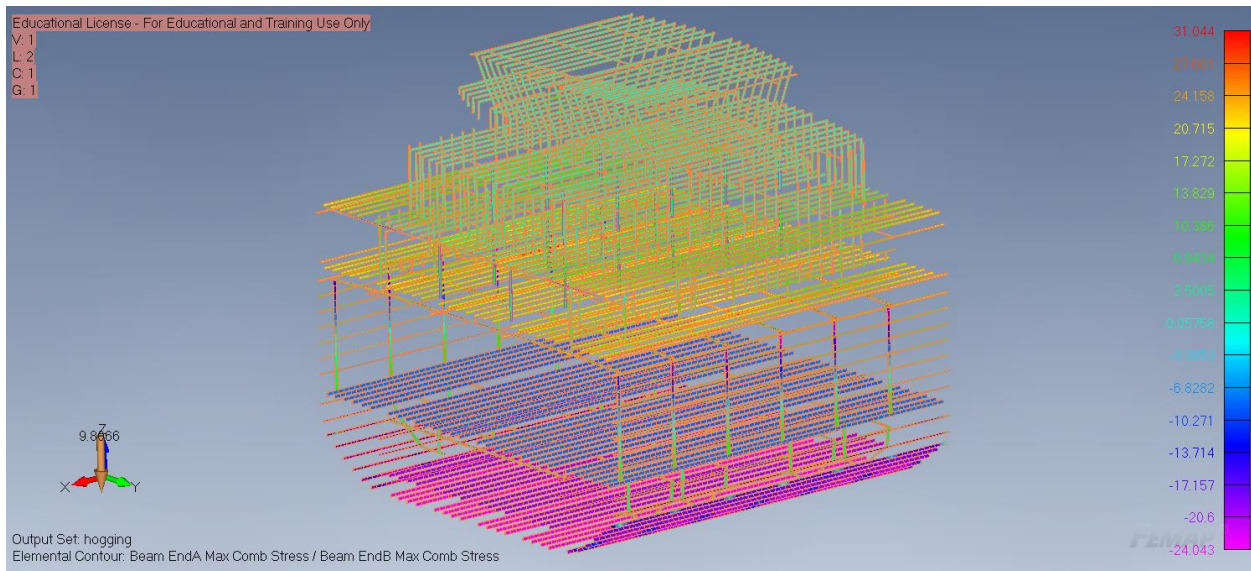

Slika 4.3.11 - Maksimalna naprezanja profila cijelog trajekta u pregibu

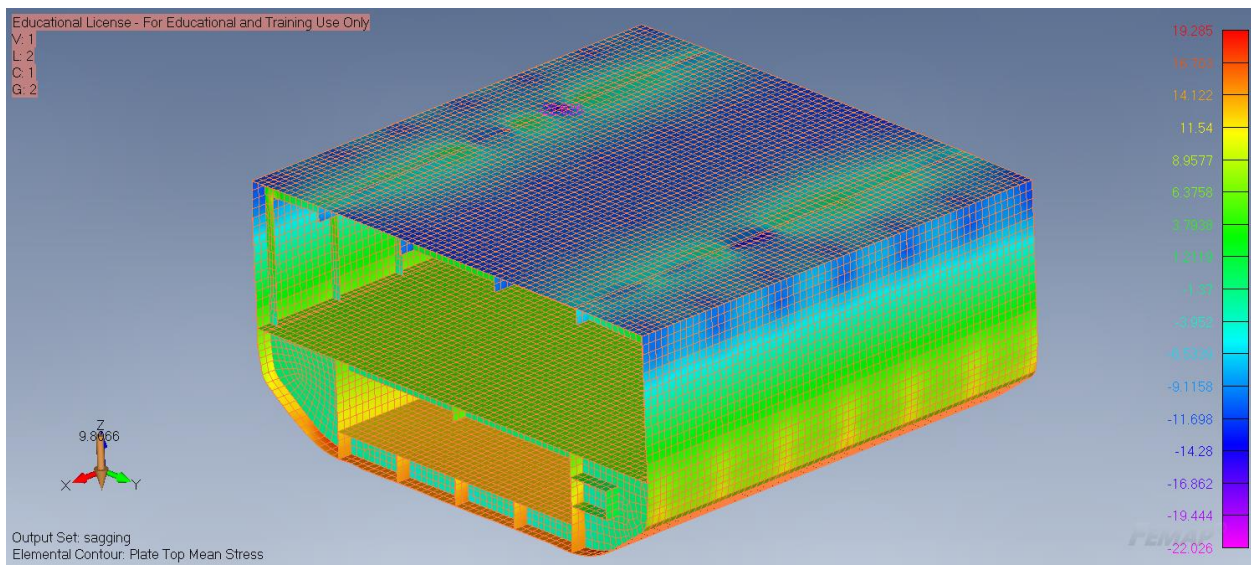

Slika 4.3.12 - Naprezanja strukture ispod putničke palube uz uključenost strukture cijelog trajekta pri progibu

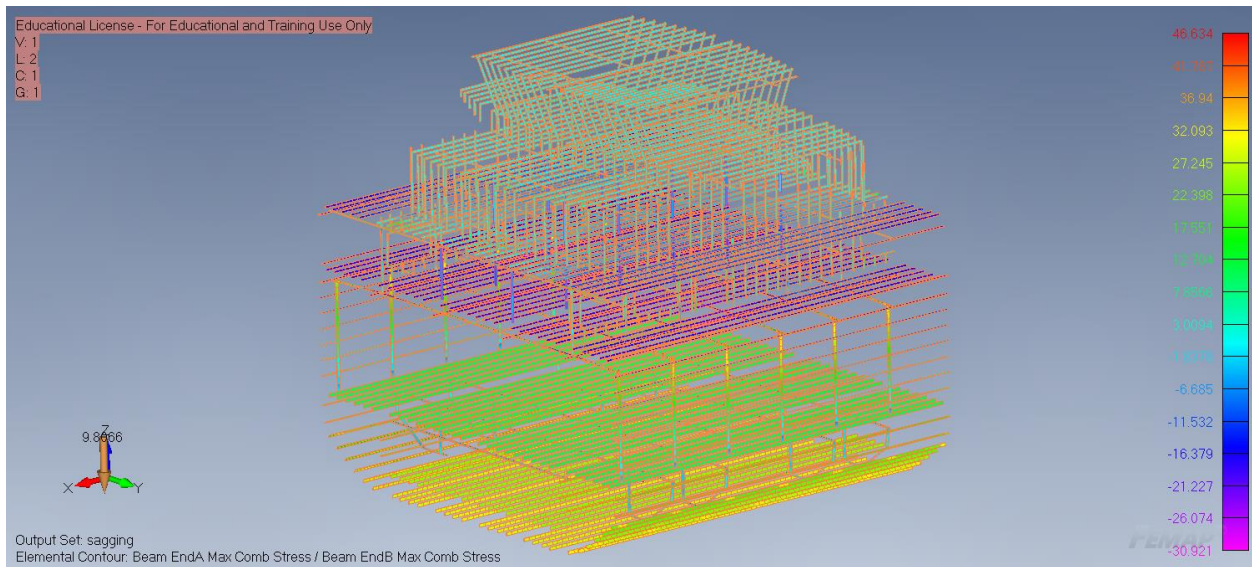

Slika 4.3.13 - Maksimalna naprezanja profila cijelog trajekta pri progibu

Slike 4.3.14-4.3.22 prikazuju vrijednosti naprezanja broda u progibu za sva tri dijela analize za strukturnu cjelinu koja se sastoji od pokrova dvodna, pregrade na rebru 15 i uzdužne pregrade dvodna na 3000 mm. Na uzdužnim pregradama prikazane su i deformacije iščitane iz FEMAP-a. Vrijednosti maksimalnih naprezanja za navedene elemente i maksimalnih deformacija cjelokupne strukture prikazane su u tablici 4.3.1.

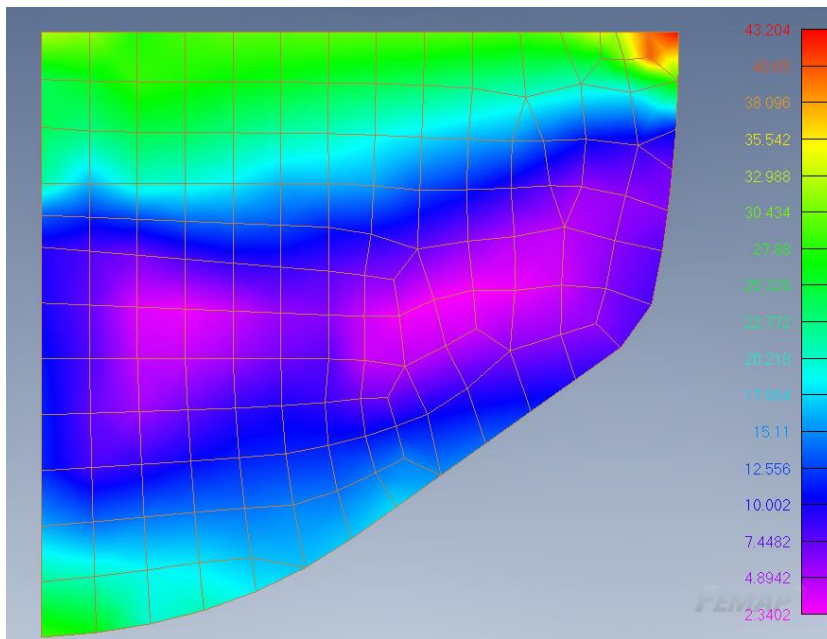

Slika 4.3.14 - Poprečna pregrada na rebru 15 u prvom dijelu analize



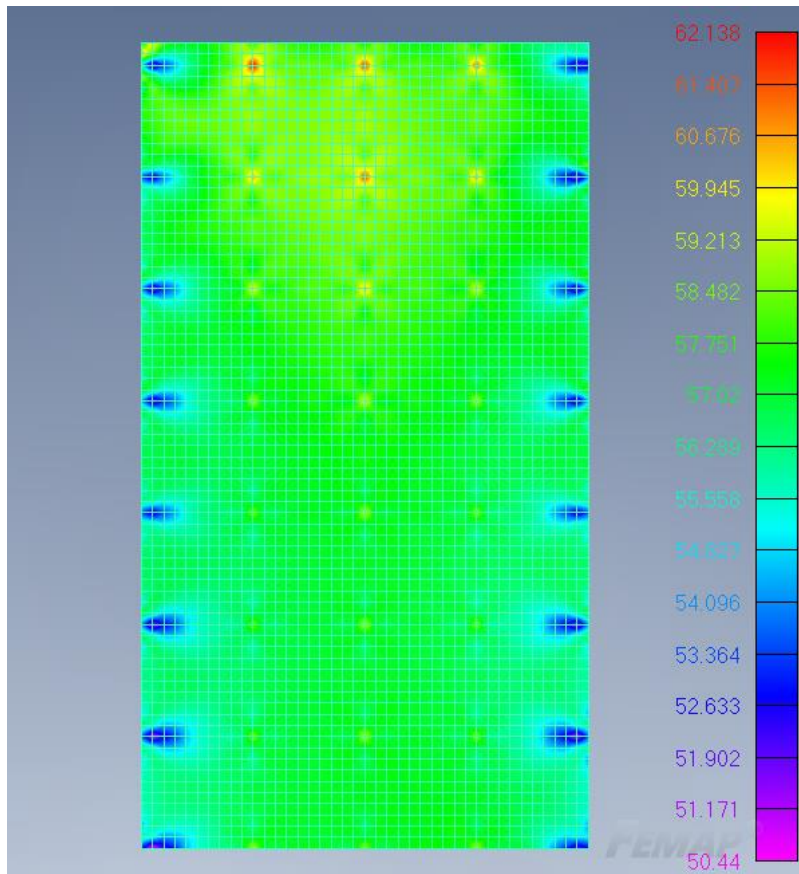

Slika 4.3.15 - Pokrov dvodna u prvom dijelu analize

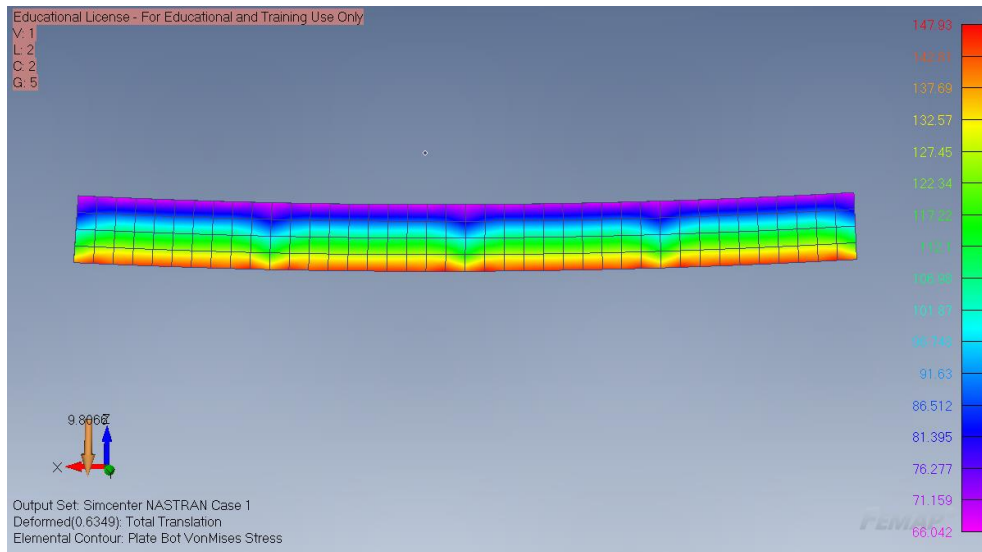

Slika 4.3.16 - Uzdužna pregrada u prvom dijelu analize

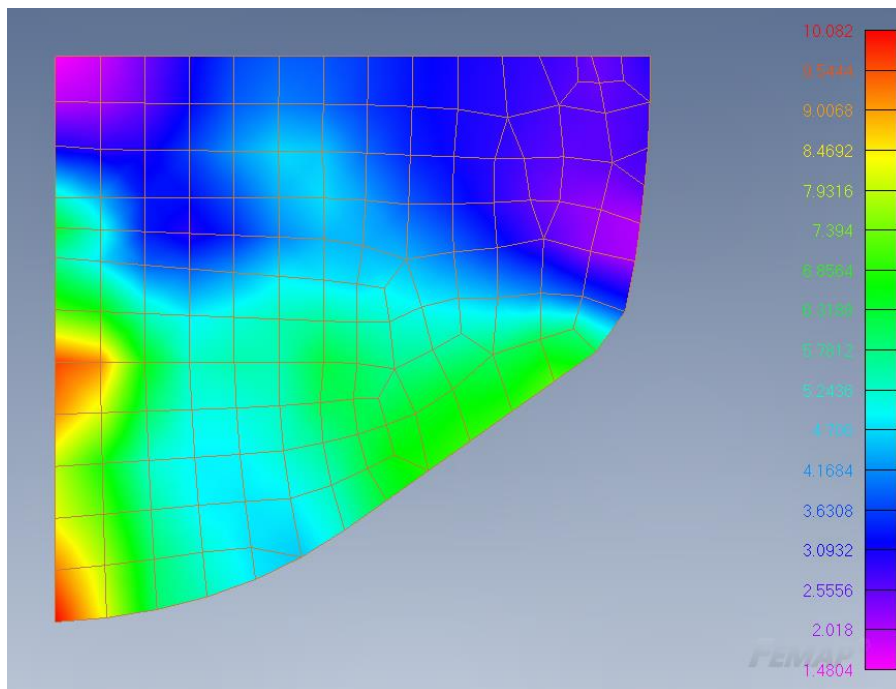

Slika 4.3.17 - Poprečna pregrada na rebru 15 u drugom dijelu analize

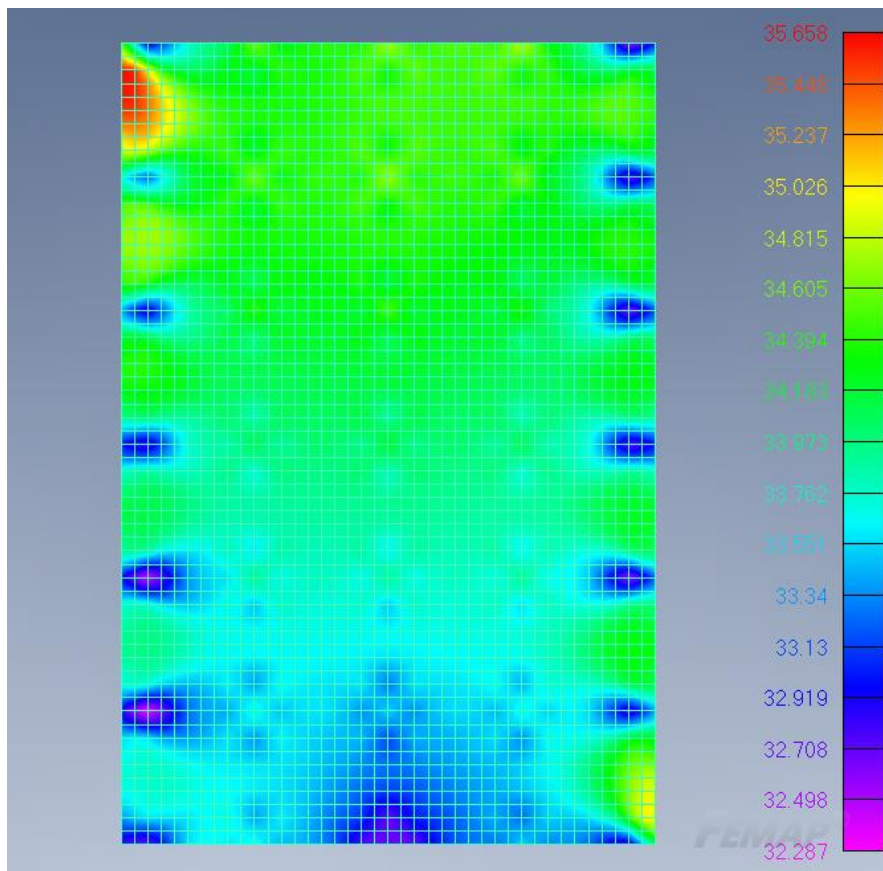

Slika 4.3.18 - Pokrov dvodna u drugom dijelu analize

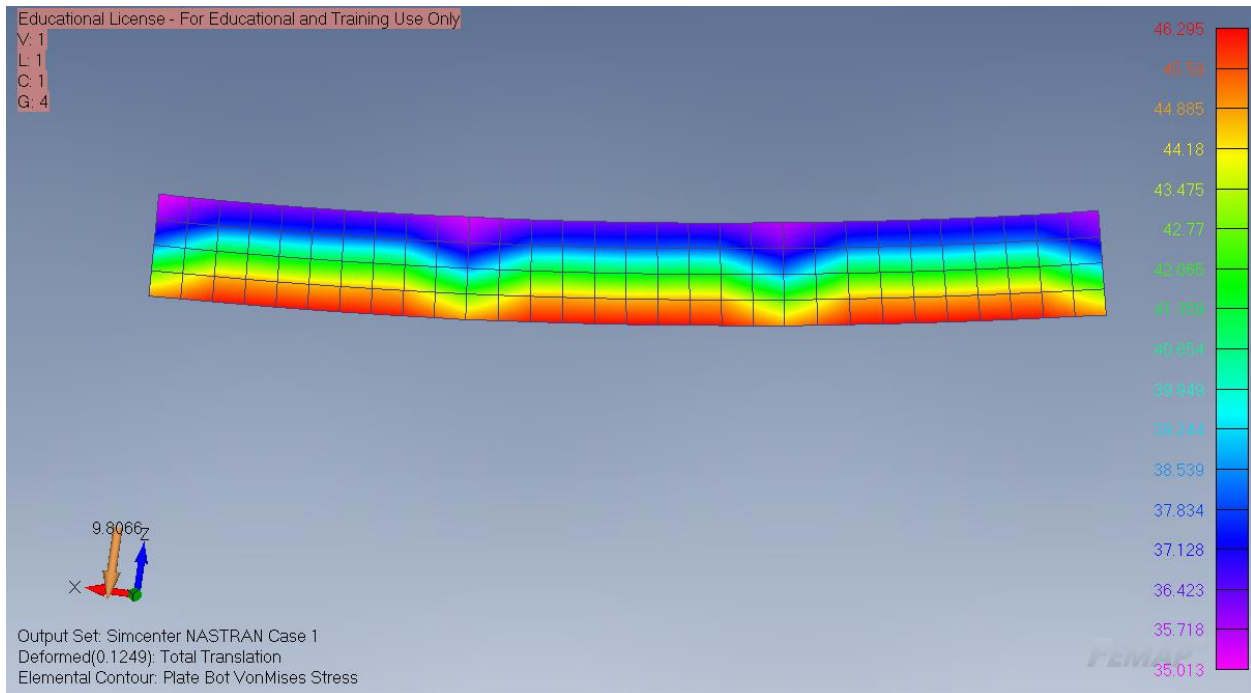

Slika 4.3.19 - Uzdužna pregrada u drugom dijelu analize

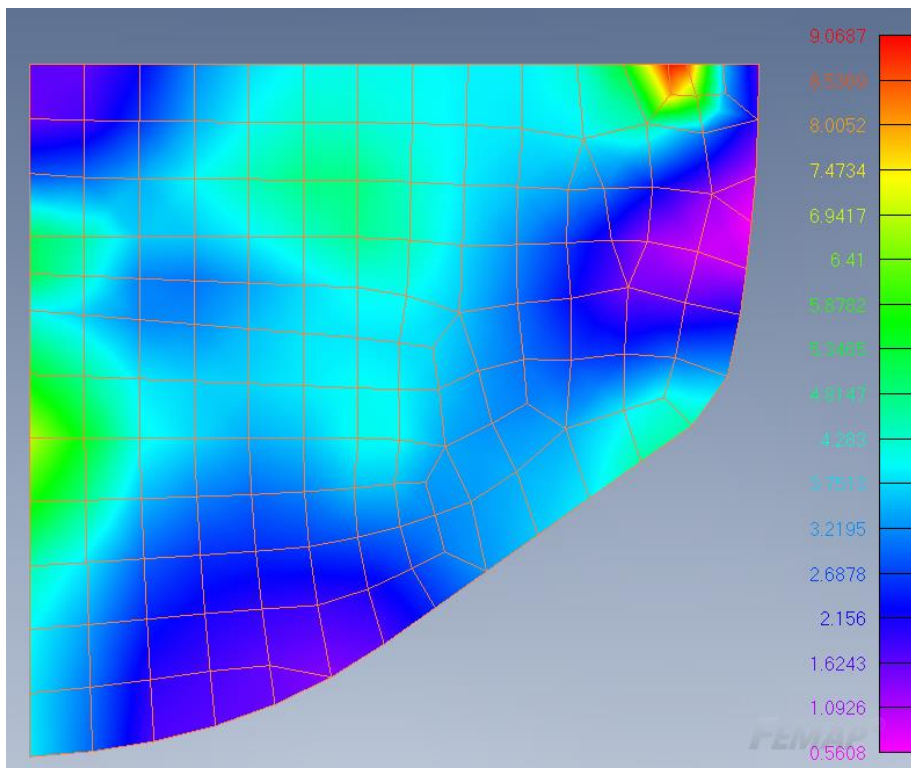

Slika 4.3.20 - Poprečna pregrada na rebru 15 u trećem dijelu analize

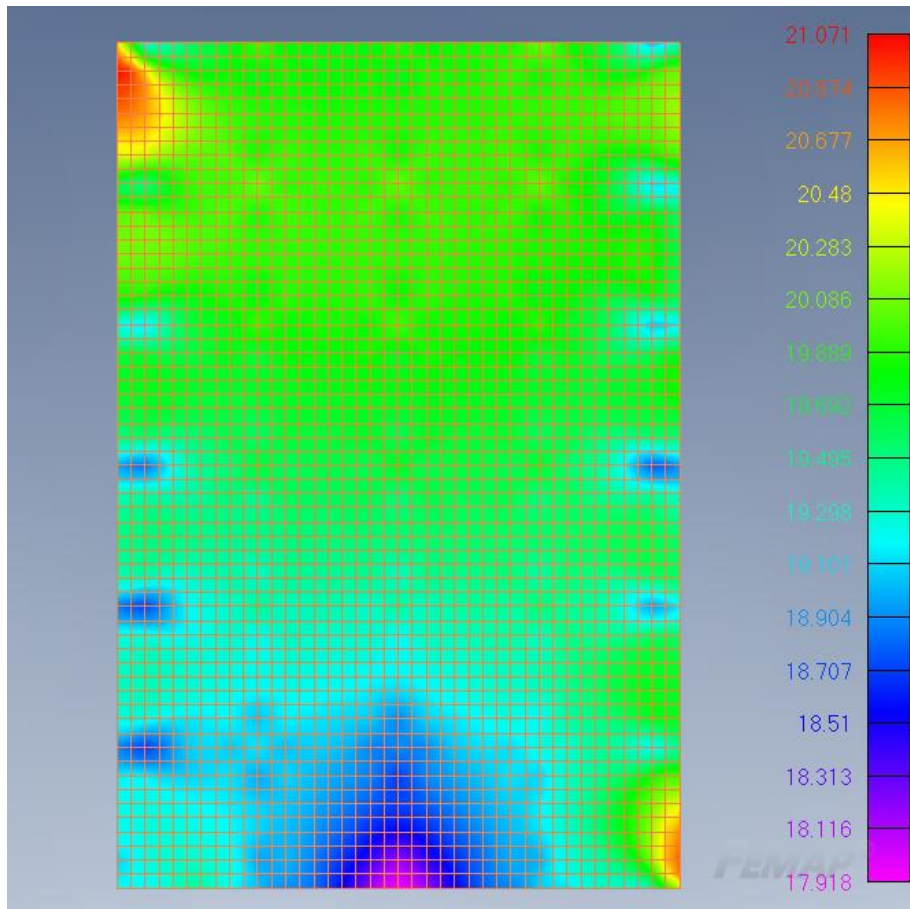

Slika 4.3.21 - Pokrov dvodna u trećem dijelu analize

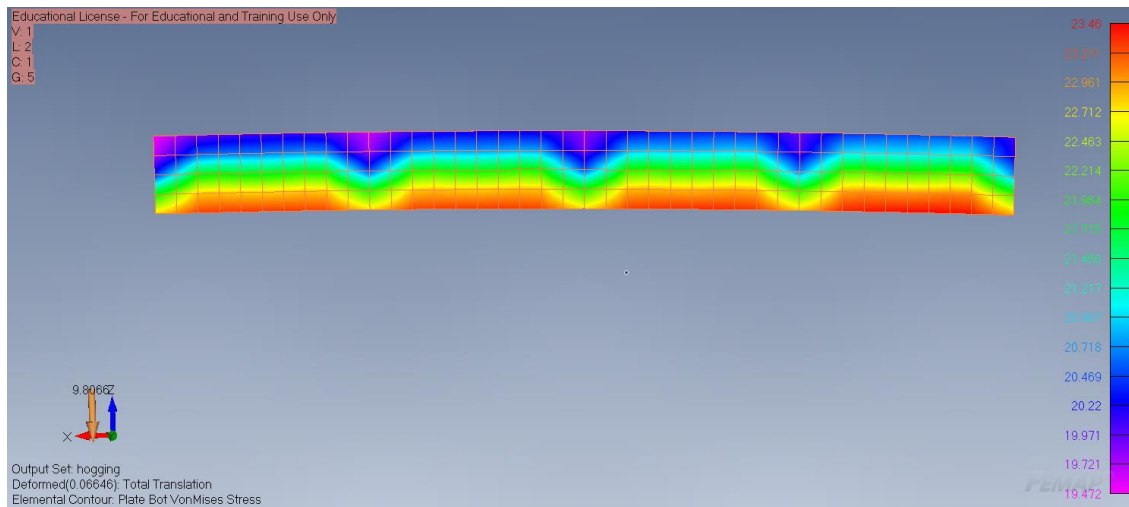

Slika 4.3.22 - Uzdužna pregrada u trećem dijelu analize

Tablica 4.3.1 - Vrijednosti maksimalnih naprezanja i deformacija za brod u progibu

Dio analize	Poprečna pregrada	Pokrov dvodna	Uzdužna pregrada	Deformacije
1. dio	43.204	62.138	147.03	635
2. dio	10.082	35.658	46.295	125
3. dio	9.0687	21.071	23.46	66
	MPa	MPa	MPa	mm

Iz tablice 4.3.1 vidljivo je da se naprezanja i deformacije značajno smanjuju s uključivanjem strukture iznad glavne palube u proračun.

## 5. Utjecaj nadgrađa na uzdužnu čvrstoću trupa broda

Potrebno je provjeriti koliko je zapravo moguće uključiti elemente iznad glavne palube u proračun uzdužne globalne čvrstoće trupa broda. U tu svrhu koristi se programski paket MARS 2000 ( u daljnjem tekstu MARS). MARS je projektni alat kreiran od strane klasifikacijskog društva Bureau Veritas uz pomoć kojeg je moguće provjeriti globalnu čvrstoću trupa.

Slika 5.1 prikazuje glavno rebro trajekta za kojeg je napravljena analiza izmodelirano u MARS-u. Na slici je prikazana provjera debljina. Radi jednostavnije provjere svakoj je debljini dodijeljena njena boja.

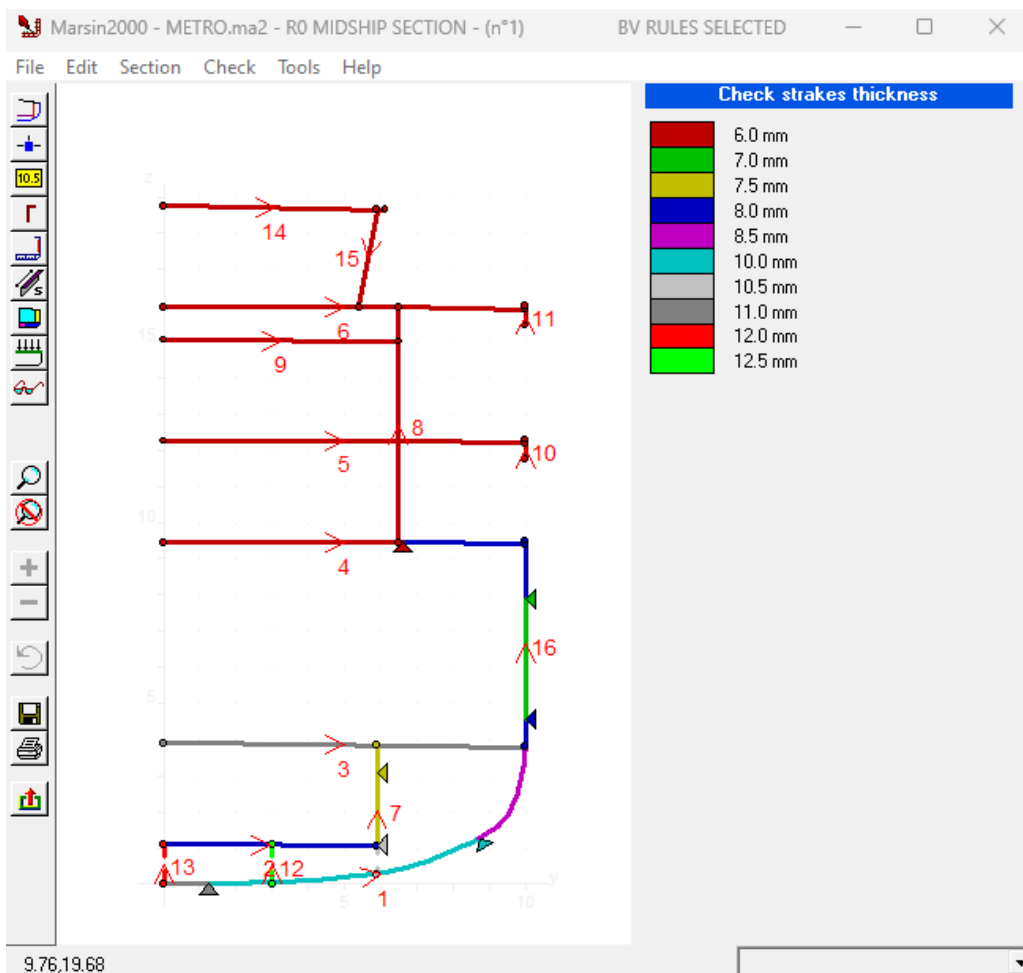

Slika 5.1 - Glavno rebro u MARS programskom paketu

U MARS-u je moguće definirati i koliko neki element zapravo sudjeluje u proračunu globalne čvrstoće trupe. Tako je, primjerice, iterativnom određeno da sunčalište sudjeluje u proračunu 65%, kako je prikazano na slici 5.2. Slika 5.3 prikazuje glavno rebro s definiranim ukrepama na putničkoj palubi.

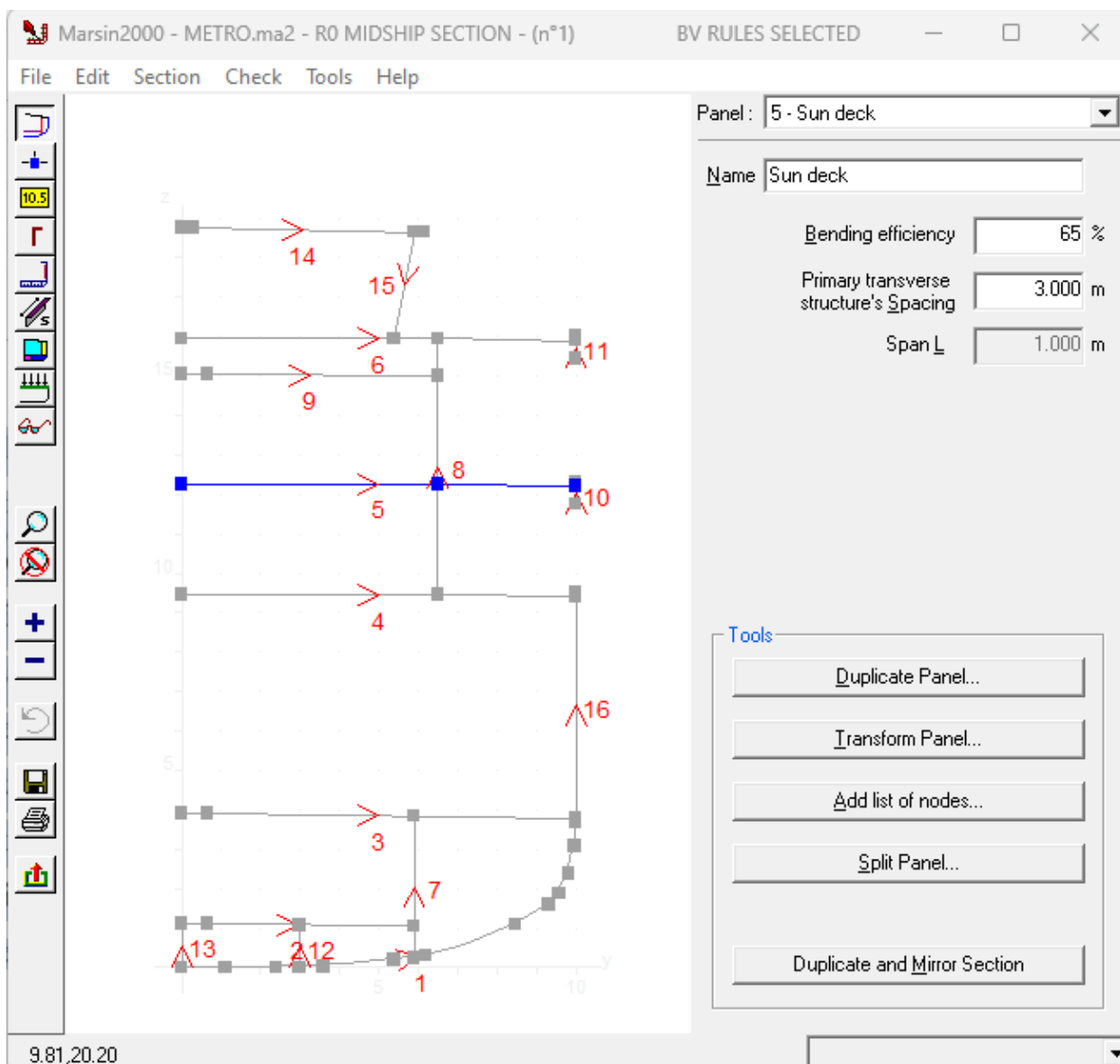

Slika 5.2 - Primjer sučelja za određivanje mogućnosti uključivanja

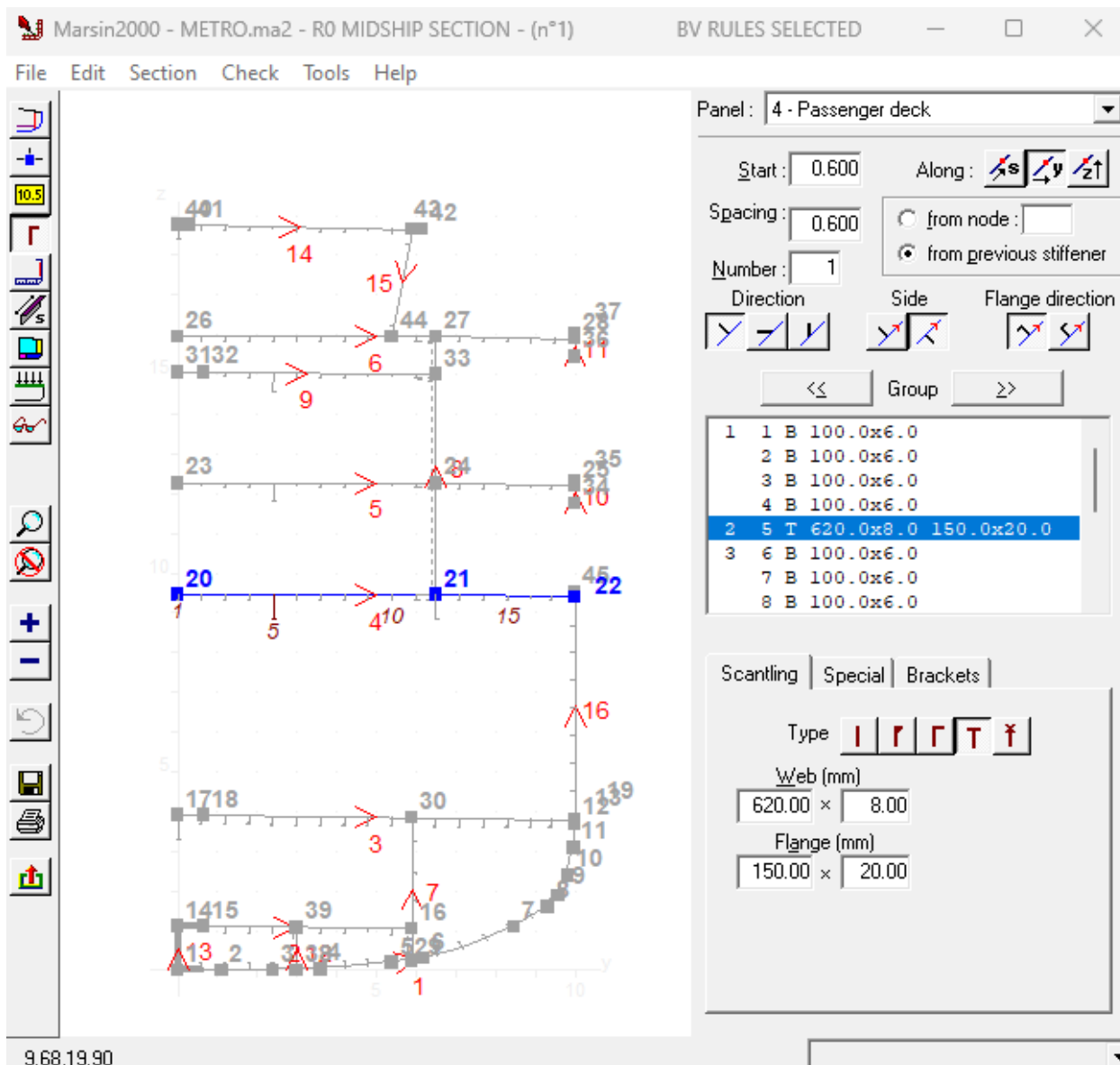

Slika 5.3 - Glavno rebro s prikazom ukrepa na putničkoj palubi

S obzirom da iz same MKE analize nije moguće odrediti koliko točno koji dio strukture sudjeluje u proračunu, potrebno je iterativnim postupkom doći do točnog rješenja. MARS nema opciju računanja normalnih naprezanja te se zaključak o postotku uključenosti strukture bazira na usporedbi vertikalnog momenta savijanja kao mjere opterećenja. Za točniju pretpostavku bilo bi potrebno varirati postotak uključenosti nadgrađa, to jest elemenata iznad glavne palube te postepeno smanjivati dimenzije strukture do glavne palube, pritom pazeći da otporni moment ostane približno isti. Zatim bi za tu promijenjenu strukturu trebalo ponoviti MKE analizu i tako iterativnim postupkom doći do točnog postotka uključenosti nadgrađa u proračun. Taj postupak je



dugotrajan i izvan opsega ovog rada, stoga je provedena samo prva točka iteracije: variranje postotka uključenosti strukture iznad glavne palube s ciljem postizanja sličnog momenta inercije glavnog rebra.

Tablica 5.1 prikazuje uzdužne dijelove glavnog rebra i njihov postotak uključenosti u proračun globalne čvrstoće. Prvi nivo, to jest struktura koja je uključena u prvi dio analize je do glavne palube (engl. main deck), drugi nivo do putničke palube (engl. passenger deck) i treći nivo obuhvaća svu strukturu navedenu u tablici. Rezultati proračuna iz MARS programskog paketa nalaze se u dodatku C ovog rada.

*Tablica 5.1 - Uključenost u proračun globalne čvrstoće*

	%
Vanjska oplata	100
Središnji nosač	100
Pokrov dvodna	100
Uzdužni nosač 3000	100
Uzdužna pregrada 6000	100
Glavna paluba	100
Vanjska oplata iznad glavne palube	100
Putnička paluba	100
Vanjska oplata nadgrađa	30
Sunčalište	65
Krov sunčališta	30
Paluba kormilarnice	10
Oplata kormilarnice	0
Krov kormilarnice	0

## 6. Zaključak

Ovaj rad bavi se strukturnom analizom i utjecajem nadgrađa na uzdužnu čvrstoću trajekta s obostrano ukrcajnim rampama. Zbog sigurnosti putnika i ostalog tereta, potrebno je pravilno dimenzionirati strukturu trupa broda. Za to je potrebno odrediti koliko je struktura nadgrađa uključena u sam proračun globalne čvrstoće.

U prvom poglavlju pisalo se o obostrano ukrcajnim trajektima. Drugo poglavlje sadrži neke od formula i konačnih vrijednosti dimenzija strukture iz proračuna prema Hrvatskom registru brodova. U trećem poglavlju provedena je analiza metodom konačnih elemenata u FEMAP-u. U četvrtom poglavlju navedeni su rezultati analize mogućnosti uključivanja struktura iznad glavne palube u proračun uzdužne čvrstoće trupa broda kroz varijaciju uključenosti elemenata pomoću MARS 2000 programskog paketa.

Iako se glavna paluba smatra palubom čvrstoće, to ne znači da i struktura iznad nje ne prima barem dio opterećenja na sebe, kako je dokazano MKE analizom i analizom kroz MARS 2000 programski paket. Točan postotak uključenosti nadgrađa u proračun globalne čvrstoće može se odrediti iterativnim postupkom i kombinacijom obje analize: potrebno je varirati postotak uključenosti strukture iznad glavne palube i dimenzije strukture do glavne palube te za varijacije ponoviti analizu metodom konačnih elemenata. U ovom je radu prikazan primjer za jedan strukturni element i metodologija izrade čitave analize utjecaja nadgrađa.

## LITERATURA

- [1] S Interneta, 9. siječnja 2024.: <https://www.autopress.hr/jadrolinija-ima-novi-trajekt-losinj/>
- [2] Bureau Veritas: “Rules for the classification of steel ships”, NR467, Pt B, Hull and Stability; siječanj 2024
- [3] Andrić, J.: „Konstrukcija broda“, s Interneta, <https://tehnika.lzmk.hr/konstrukcija-broda/>, 9. siječnja 2024.
- [4] CROATIAN REGISTER OF SHIPPING: “RULES FOR THE CLASSIFICATION OF SHIPS, Part 2 – HULL”, s Interneta, <https://www.crs.hr/rules-imo-and-eu-regulations/crs-rules-and-standards/rules-for-the-classification-of-ships> , 9. siječnja 2024.
- [5] NX NASTRAN User Guide, s Interneta, [https://docs.plm.automation.siemens.com/data\\_services/resources/nxnastran/11/help/tdoc/en\\_US/pdf/User.pdf](https://docs.plm.automation.siemens.com/data_services/resources/nxnastran/11/help/tdoc/en_US/pdf/User.pdf) , 15. siječnja 2024.
- [6] Bureau Veritas: „NI640 GUIDANCE NOTE FOR STRUCTURAL ASSESSMENT OF PASSENGER SHIPS AND RO-RO SHIPS“, s Interneta, <https://marine-offshore.bureauveritas.com/ni640-guidance-note-structural-assessment-passenger-ships-and-ro-ro-ships> , 10. siječnja 2024.
- [7] Bureau Veritas: MARS2000 User’s guide

## POPIS OZNAKA I KRATICA

B – širina broda

$C_b$  – koeficijent punoće istisnine

$C_W$  – koeficijent punoće vodne linije

d – gaz broda na konstrukcijskoj vodnoj liniji

D – visina broda

E – modul elastičnosti materijala

I – moment inercije

k – faktor materijala (za obični brodograđevni čelik iznosi 1, za čelik povišene čvrstoće kvalitete AH36 iznosi 0,72)

L – dužina broda

Pa – paskal, mjerna jedinica

$p_D$  – opterećenje palube

$p_F$  – opterećenje sponja

$p_G$  – opterećenje nosača

$p_S$  – opterećenje bočnih i pramčanih elemenata

$p_0$  – osnovno vanjsko opterećenje elementa strukture (engl. basic external load)

s – udaljenost među profilima

z – visina elementa

W – otporni moment

$C_a$ ,  $C_F$ , M,  $F_1$ ,  $F_2$  – faktori koji ovisi o uzdužnom položaju elementa

$\tau_L$  – najveća projektna smična sila uslijed uzdužnog savijanja nosača

$\sigma_L$  – najveće normalno opterećenje uzdužnog nosača

$\sigma$  – dopušteno normalno naprezanje

## SAŽETAK I KLJUČNE RIJEČI

Za predloženi trajekt za prijevoz putnika i automobila sa obostranim ukrcajnim rampama i za ograničeno područje plovidbe u Jadranu provedena je analiza utjecaja nadgrađa na uzdužnu čvrstoću. Analiza mogućnosti uključivanja strukture iznad glavne palube u proračun uzdužne (globalne) čvrstoće trupa broda provedena je kombinacijom rezultata analize metodom konačnih elemenata u Siemens FEMAP-u i varijacijom postotka uključenosti elemenata iznad glavne palube kroz MARS 2000 programski paket. Iako se glavna paluba smatra palubom čvrstoće, to ne znači da i struktura iznad nje ne prima barem dio opterećenja na sebe, kako je dokazano objema analizama.

Ključne riječi: MKE, metoda konačnih elemenata, nadgrađe, trajekt

A sensitivity analysis of the superstructure on the longitudinal strength was carried out for the proposed Ro-Pax ship: a ferry for the transport of passengers and cars with two-sided boarding ramps and for a limited navigation area in the Adriatic. The analysis was carried out by combining the results of the FEA (finite element analysis) in Siemens FEMAP and the using the MARS 2000 software package to variate the inclusion percentage of the elements above the main deck in the calculation of the longitudinal global strength of the ship's hull. Although the main deck is considered a strength deck, this does not mean that the structure above it does not also receive at least some of the load on itself, as proven by both analyses.

Key words: FEA, finite element analysis, superstructure, ferry

## DODATAK A – Dimenzioniranje strukture po pravilima Hrvatskog registra brodova

### 3 DESIGN LOADS

#### 3.1 General

##### 3.1.2 Definitions

###### 3.1.2.1 Load centre:

a) For plates:

- vertical stiffening system:

0,5x stiffener spacing above the lower support of plate field, or lower edge of plate when the thickness changes within the plate field;

- horizontal stiffening system:

midpoint plate field.

b) For stiffeners and girders:

- centre of span  $l$ .

###### 3.1.2.2 Definition of symbols:

$v$  = ship's speed according to Section 1.2.6;

$\rho_c$  = density of cargo as stowed, [t/m<sup>3</sup>];

$\rho$  = density of liquids, [t/m<sup>3</sup>];

$\rho$  = 1,025 t/m<sup>3</sup> for fresh and sea water;

$z$  = vertical distance of the structure's load centre above base line, [m];

$x$  = distance from aft end of length  $L$ , [m];

$C_b$  = block coefficient according to 1.2.6.1., but is not to be taken less than 0,60;

$p_0 = 2,1 (C_b + 0,7) \cdot C_W \cdot C_L \cdot f$  [kN/m<sup>2</sup>];

$C_W = 10,75 - \left(\frac{300-L}{100}\right)^{1,5}$ ;

$C_L = 1,0$ ;

$f = 1$  for shell plating and weather deck;

$f = 0,75$  for frames and deck beams

$f = 0,60$  for web frames, stringers and grillage systems.

**Note:** For restricted service areas these values  $p_0$  may be decreased, as follows:

10% for service range 2

25% for service range 3

30% for service range 4, 5

40% for service range 6, 7, 8

$$C_{sr} = 0,7$$

$$v = 10 \text{ knots}$$

$$\rho = 1,025 \text{ t/m}^3$$

$$L = 92,7 \text{ m}$$

$$d = 2,5 \text{ m}$$

$$C_b = 0,60$$

$$D = 3,8 \text{ m}$$

$$B = 20 \text{ m}$$

$$C_W = 10,75 - \left( \frac{300 - L}{100} \right)^{1,5} = 7,765$$

$$C_L = 1,0$$

Basic external load for shell plating and weather decks:

$$f_s = 1,0$$

$$p_{0_s} = 2,1 + (C_b + 0,7) \cdot C_W \cdot C_L \cdot f_s \cdot C_{sr} = 14,84 \text{ kN/m}^2$$

Basic external load for frames and deck beams:

$$f_f = 0,75$$

$$p_{0_f} = 2,1 + (C_b + 0,7) \cdot C_W \cdot C_L \cdot f_f \cdot C_{sr} = 11,13 \text{ kN/m}^2$$

Basic external load for web frames, stringers and grillage systems:

$$f_g = 0,60$$

$$p_{0_g} = 2,1 + (C_b + 0,7) \cdot C_W \cdot C_L \cdot f_g \cdot C_{sr} = 8,90 \text{ kN/m}^2$$

### 3.2 External sea loads

#### 3.2.1 Load on weather deck

3.2.1.1 Load on weather decks is determined according to:

$$p_D = p_0 \cdot \frac{20 \cdot d}{(10 + z - d) \cdot D} \cdot C_a, [\text{kN/m}^2]$$

where the factor depending on the longitudinal position,  $C_a$ , is determined according to:

$$C_a(x) = \begin{cases} 1,2 - \frac{x}{L}, & \text{if } 0 \leq \frac{x}{L} < 0,2 \\ 1,0, & \text{if } 0,2 \leq \frac{x}{L} < 0,7 \\ 1,0 + \frac{C}{3} \left( \frac{x}{L} - 0,7 \right), & \text{if } 0,7 \leq \frac{x}{L} \leq 1,0 \end{cases}$$

$$C = 0,15 \cdot L - 10 = 5$$

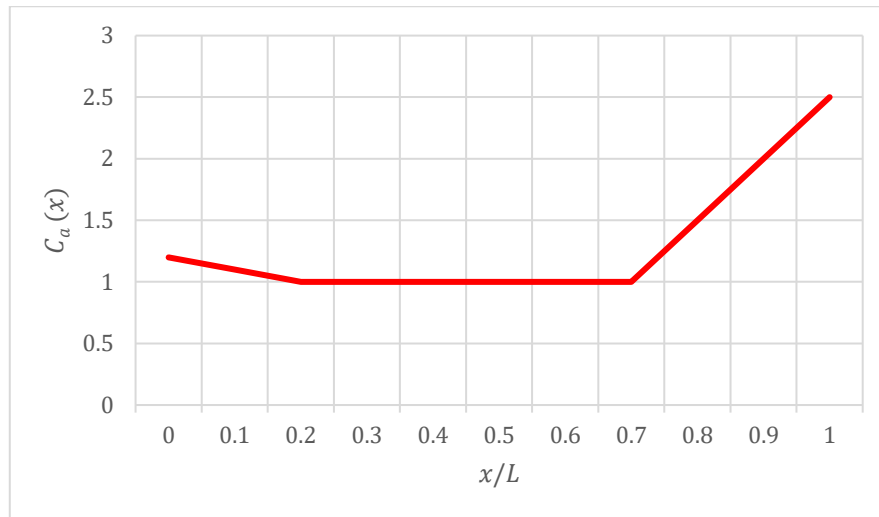

Shell (plating of deck):

Passenger deck – 9400 ABL

$$x = 46,35 \text{ m}$$

$$z = 9,4 \text{ m}$$

$$p_{D_s}(x, z, C_a) = p_{0_s} \cdot \frac{20 \cdot d}{(10+z-d) \cdot D} \cdot C_a(x) = 11,56 \text{ kN/m}^2$$

Sun deck – 12200 ABL

$$x = 46,35 \text{ m}$$

$$z = 12,2 \text{ m}$$

$$p_{D_s}(x, z, C_a) = p_{0_s} \cdot \frac{20 \cdot d}{(10+z-d) \cdot D} \cdot C_a(x) = 9,91 \text{ kN/m}^2$$

Wheelhouse deck – 15900 ABL

$$x = 46,35 \text{ m}$$

$$z = 15,9 \text{ m}$$

$$p_{D_s}(x, z, C_a) = p_{0_s} \cdot \frac{20 \cdot d}{(10+z-d) \cdot D} \cdot C_a(x) = 8,35 \text{ kN/m}^2$$

Frames (deck beams):

Passenger deck – 9400 ABL

$$x = 46,35 \text{ m}$$

$$z = 9,4 \text{ m}$$

$$p_{D_f}(x, z, C_a) = p_{0_f} \cdot \frac{20 \cdot d}{(10+z-d) \cdot D} \cdot C_a(x) = 8,67 \text{ kN/m}^2$$



Sun deck – 12200 ABL

$$x = 46,35 \text{ m}$$

$$z = 12,2 \text{ m}$$

$$p_{D_f}(x, z, C_a) = p_{0_f} \cdot \frac{20 \cdot d}{(10+z-d) \cdot D} \cdot C_a(x) = 7,43 \text{ kN/m}^2$$

Wheelhouse deck – 15900 ABL

$$x = 46,35 \text{ m}$$

$$z = 15,9 \text{ m}$$

$$p_{D_f}(x, z, C_a) = p_{0_f} \cdot \frac{20 \cdot d}{(10+z-d) \cdot D} \cdot C_a(x) = 6,26 \text{ kN/m}^2$$

Girders:

Passenger deck – 9400 ABL

$$x = 46,35 \text{ m}$$

$$z = 9,4 \text{ m}$$

$$p_{D_g}(x, z, C_a) = p_{0_g} \cdot \frac{20 \cdot d}{(10+z-d) \cdot D} \cdot C_a(x) = 6,93 \text{ kN/m}^2$$

Sun deck – 12200 ABL

$$x = 46,35 \text{ m}$$

$$z = 12,2 \text{ m}$$

$$p_{D_g}(x, z, C_a) = p_{0_g} \cdot \frac{20 \cdot d}{(10+z-d) \cdot D} \cdot C_a(x) = 5,95 \text{ kN/m}^2$$

Wheelhouse deck – 15900 ABL

$$x = 46,35 \text{ m}$$

$$z = 15,9 \text{ m}$$

$$p_{D_g}(x, z, C_a) = p_{0_g} \cdot \frac{20 \cdot d}{(10+z-d) \cdot D} \cdot C_a(x) = 5,01 \text{ kN/m}^2$$

### 3.2.1.2 Strength decks treated as weather decks and forecastle decks

Shell (deck plating):

$$p_{D_{min_s}} = \max(16 \cdot f_s, 0,7 \cdot p_{0_s}) = 16 \text{ kN/m}^2$$

Frames (deck beams):

$$p_{Dmin_f} = \max(16 \cdot f_f, 0,7 \cdot p_{0_f}) = 12 \text{ kN/m}^2$$

Girders:

$$p_{Dmin_g} = \max(16 \cdot f_g, 0,7 \cdot p_{0_g}) = 9,6 \text{ kN/m}^2$$

### 3.2.2 Load on ship's sides and of bow structures

#### 3.2.2.1 Load on ship's sides

The external load on the ship's sides is determined according to the following:

a) For elements which load centre is located below load waterline:

$$p_s = 10(d - z) + p_0 \cdot C_F \left(1 + \frac{z}{d}\right), [\text{kN/m}^2];$$

b) For elements which load centre is located above load waterline:

$$p_s = p_0 \cdot C_F \frac{20}{10+z-d}, [\text{kN/m}^2];$$

where the factor depending on the longitudinal position,  $C_F$ , is determined according to:

$$C_F(x) = \begin{cases} 1,0 + \frac{5}{c_b} \left(0,2 - \frac{x}{L}\right), & \text{if } 0 \leq \frac{x}{L} < 0,2 \\ 1,0, & \text{if } 0,2 \leq \frac{x}{L} < 0,7 \\ 1,0 + \frac{20}{c_b} \left(\frac{x}{L} - 0,7\right)^2, & \text{if } 0,7 \leq \frac{x}{L} \leq 1,0 \end{cases}$$

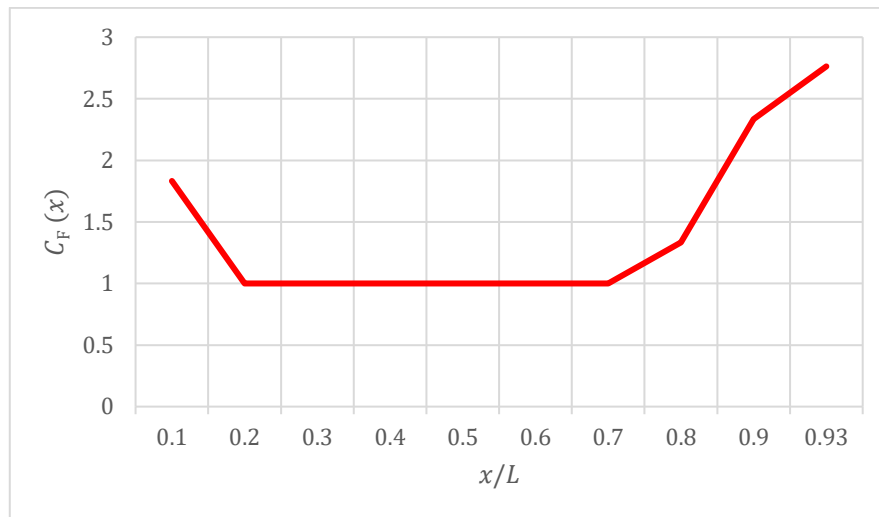

Shell:

Elements below load waterline

$$x = 46,35 \text{ m}$$

$$z = 0,3 \text{ m}$$

$$p_{S_s}(x, z) = 10(d - z) + p_{0_s} \cdot C_F(x) \cdot \left(1 + \frac{z}{d}\right) = 38,62 \text{ kN/m}^2$$

Opločenje boka (Tank top – Main deck)

$$x = 46,35 \text{ m}$$

$$z = 1,35 \text{ m}$$

$$p_{S_s}(x, z) = 10(d - z) + p_{0_s} \cdot C_F(x) \cdot \left(1 + \frac{z}{d}\right) = 34,36 \text{ kN/m}^2$$

Ukrepe boka (Tank top – Main deck)

$$x = 46,35 \text{ m}$$

$$z = 2,425 \text{ m}$$

$$p_{S_s} = p_{0_s} \cdot C_F(x) \cdot \frac{20}{10+z-d} = 29,91 \text{ kN/m}^2$$

Opločenje boka (Main deck – Forecastle deck)

$$x = 46,35 \text{ m}$$

$$z = 4,1 \text{ m}$$

$$p_{S_s} = p_{0_s} \cdot C_F(x) \cdot \frac{20}{10+z-d} = 25,59 \text{ kN/m}^2$$

Ukrepe boka (Main deck – Forecastle deck)

$$x = 46,35 \text{ m}$$

$$z = 5,2 \text{ m}$$

$$p_{S_s} = p_{0_s} \cdot C_F(x) \cdot \frac{20}{10+z-d} = 23,37 \text{ kN/m}^2$$

Opločenje boka (Forecastle – Passenger deck)

$$x = 46,35 \text{ m}$$

$$z = 6,9 \text{ m}$$

$$p_{S_s} = p_{0_s} \cdot C_F(x) \cdot \frac{20}{10+z-d} = 20,61 \text{ kN/m}^2$$

Ukrepe boka (Forecastle – Passenger deck)

$$x = 46,35 \text{ m}$$

$$z = 8,0 \text{ m}$$

$$p_{S_s} = p_{0_s} \cdot C_F(x) \cdot \frac{20}{10+z-d} = 19,15 \text{ kN/m}^2$$

Bottom longitudinals

$$x = 46,35 \text{ m}$$

$$z = 0,0 \text{ m}$$

$$p_{sf}(x, z) = 10(d - z) + p_{0f} \cdot C_F(x) \cdot \left(1 + \frac{z}{d}\right) = 36,13 \text{ kN/m}^2$$

Uzdužnjaci boka (Tank top – Main deck)

$$x = 46,35 \text{ m}$$

$$z = 1,35 \text{ m}$$

$$p_{sf}(x, z) = 10(d - z) + p_{0f} \cdot C_F(x) \cdot \left(1 + \frac{z}{d}\right) = 28,64 \text{ kN/m}^2$$

Uzdužnjaci boka (Main deck – Forecastle deck)

$$x = 46,35 \text{ m}$$

$$z = 4,1 \text{ m}$$

$$p_{sf} = p_{0f} \cdot C_F(x) \cdot \frac{20}{10+z-d} = 19,19 \text{ kN/m}^2$$

Uzdužnjaci boka (Forecastle – Passenger deck)

$$x = 46,35 \text{ m}$$

$$z = 6,9 \text{ m}$$

$$p_{sf} = p_{0f} \cdot C_F(x) \cdot \frac{20}{10+z-d} = 15,46 \text{ kN/m}^2$$

Uzdužnjaci boka (Passenger deck – Wheelhouse deck)

$$x = 46,35 \text{ m}$$

$$z = 9,7 \text{ m}$$

$$p_{sf} = p_{0f} \cdot C_F(x) \cdot \frac{20}{10+z-d} = 12,94 \text{ kN/m}^2$$

### 3.2.3 Load on the ship's bottom

The external load of the ship's bottom is determined according to:

$$p_B = 10 \cdot d + p_0 \cdot C_F, [\text{kN/m}^2].$$

$$x = 46,35 \text{ m}$$

$$p_B(x) = 10 \cdot d + p_0 \cdot C_F(x) = 39,84 \text{ kN/m}^2$$

### 3.2.5 Load on decks of superstructures and deckhouses

The load on exposed decks and parts of superstructure and deckhouse decks is determined as follows:

$$p_{DA} = p_D \cdot n, [\text{kN/m}^2]$$

where:

$p_D$  = as calculated in 3.2.1.1;

$$n = 1 - \frac{z-D}{10};$$

$$n_{min} = 0,5;$$

$n = 1,0$  for the forecastle deck.

For deckhouses the value determined may be multiplied by the factor:

$$\left(0,7 \cdot \frac{b'}{B'} + 0,3\right)$$

where:

$b'$  = breadth of deckhouse;

$B'$  = largest breadth of ship at the position considered.

Forecastle

$$n = 1$$

$$p_D = 16 \text{ kN/m}^2$$

$$p_{DA_{forecastle}} = p_D \cdot n = 16 \text{ [kN/m}^2\text{]}$$

Passenger deck

$$n = 0,5$$

$$p_D = 11,56 \text{ kN/m}^2$$

$$p_{DA_{passenger}} = p_D \cdot n = 5,78 \text{ [kN/m}^2\text{]}$$

Sun deck

$$n = 0,5$$

$$p_D = 9,91 \text{ kN/m}^2$$

$$p_{DA_{sun}} = p_D \cdot n = 4,96 \text{ [kN/m}^2\text{]}$$

Deckhouses

$$b' = 20 \text{ m}$$

$$B' = 20 \text{ m}$$

$$\left(0,7 \cdot \frac{b'}{B'} + 0,3\right) = 1,0$$

Plating

$$n = 0,5$$

$$p_D = 8,35 \text{ kN/m}^2$$

$$p_{DA_{plating}} = p_D \cdot n = 4,17 \text{ [kN/m}^2\text{]}$$

Frames

$$n = 0,5$$

$$p_D = 5,00 \text{ kN/m}^2$$

$$p_{DA_{stiffeners}} = p_D \cdot n = 2,50 \text{ [kN/m}^2\text{]}$$

Girders

$$n = 0,5$$

$$p_D = 5,00 \text{ kN/m}^2$$

$$p_{DA_{girders}} = p_D \cdot n = 2,50 \text{ [kN/m}^2\text{]}$$

### 3.3 Cargo loads, load on accommodation decks

#### 3.3.1 Load on cargo decks

##### 3.3.1.1 Load on exposed decks and parts of superstructure and deckhouse decks

The load is determined according to:

$$p_L = p_C (1 + a_v), \text{ [kN/m}^2\text{]},$$

where:

$p_C$  = static cargo load, [kN/m<sup>2</sup>];

$p_C = 7 \cdot h$  for 'tween decks but not less than 15 kN/m<sup>2</sup> if no cargo load is given;

$h$  = mean 'tween deck height, [m],

and the acceleration factor,  $a_v$ , is calculated:

$$a_v = F \cdot m;$$

$$F = 0,11 \frac{v}{\sqrt{L}};$$

$$m(x) = \begin{cases} m_0 - 5(m_0 - 1) \frac{x}{L}, & \text{if } 0 < \frac{x}{L} \leq 0,2 \\ 1,0, & \text{if } 0,2 \leq \frac{x}{L} \leq 0,7; \\ 1 + \frac{m_0 + 1}{0,3} \left( \frac{x}{L} - 0,7 \right), & \text{if } 0,7 < \frac{x}{L} \leq 1,0 \end{cases}$$

$$m_0 = 1,5 + F.$$

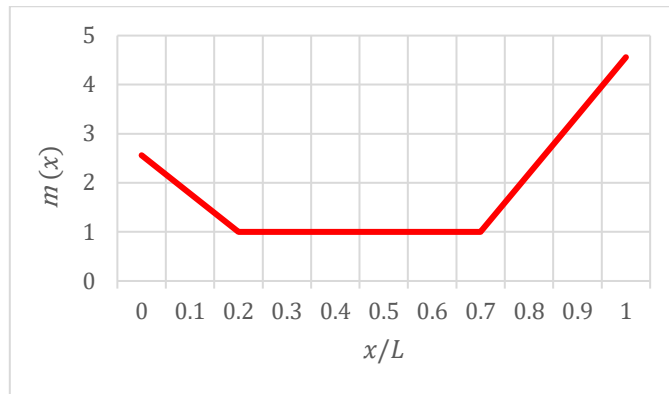

$$h = 2,475 \text{ m}$$

$$p_C = 7 \cdot h = 17,325 \text{ kN/m}^2$$

$$F = 0,11 \frac{v}{\sqrt{L}} = 1,06 \text{ kN}$$

$$m_0 = 1,5 + F = 2,56 \text{ t}$$

$$a_v(0,5) = F \cdot m(x) = 1,06 \text{ m/s}^2$$

$$p_L(0,5) = p_C [1 + a_v(0,5)] = 35,69 \text{ kN/m}^2$$

### 3.3.1.2 Load on timber and coke deck

The load is determined by:

$$p_L = 5 \cdot h_s(1 + a_v), [\text{kN/m}^2],$$

$h_s$  = stowing height of cargo, [m].

$$h_s = 3,8 \text{ m}$$

$$p_L = 5 \cdot h_s(1 + a_v) = 39,14 \text{ kN/m}^2,$$

### 3.3.2 Load on inner bottom

#### 3.3.2.1 Inner bottom cargo load

The inner bottom cargo load is determined as follows:

$$p_{DB} = 9,81 \cdot \frac{G}{V} \cdot h(1 + a_v), [\text{kN/m}^2],$$

where:

$G$  = mass of cargo in the hold, [t];

$V$  = volume of the hold (hatchways excluded), [m<sup>3</sup>];

$h$  = height of the highest point of the cargo above the inner bottom, [m].

$$G = 81,5 \text{ t}$$

$$V = 1223,6 \text{ m}^3$$

$$h = 3,8 \text{ m}$$

$$a_v = 1,06 \text{ m/s}^2$$

$$p_{DB} = 9,81 \cdot \frac{G}{V} \cdot h(1 + a_v) = 5,11 \text{ kN/m}^2$$

### 3.3.3 Loads on accommodation and machinery decks

#### 3.3.3.1 Load in accommodation and service spaces

$$p = 3,5 (1 + a_v) = 7,21 \text{ kN/m}^3$$

#### 3.3.3.2 Load of machinery deck

$$p = 8 (1 + a_v) = 16,47 \text{ kN/m}^3$$

## 3.4 Load on tank structures

### 3.4.1 Design pressure for filled tanks

#### 3.4.1.1 Design pressure for service conditions

The design pressure for service conditions is the greater of the following values:

$$p_1 = 9,81 \cdot h_1 \cdot \rho \cdot (1 + a_v) + 100 \cdot p_v, [\text{kN/m}^2]$$

or

$$p_1 = 9,81 \cdot \rho \cdot [h_1 \cdot \cos \varphi + (0,3 \cdot b + y) \cdot \sin \varphi] + 100 \cdot p_v, [\text{kN/m}^2]$$

where:

$h_1$  = distance of load centre from tank top [m];

$\varphi$  = design heeling angle for tanks [°];

$$\varphi = \tan^{-1} \left( f_{bk} \cdot \frac{D}{B} \right);$$

$f_{bk} = 0,5$  for ships with bilge keel;

$f_{bk} = 0,6$  for ships without bilge keel;

$\varphi \geq 20^\circ$  for hatch covers of holds carrying liquids;

$b$  = upper breadth of tank [m];

$y$  = distance of load centre from the vertical longitudinal central plane of tank [m];

$p_v$  = set pressure of pressure relief valve [bar];

$p_{vmin} = 0,1$  bar during ballast water exchange for both sequential and flow-through method;

$p_{vmin} = 0,2$  bar for cargo tanks of tankers.

$$a_v = 1,06 \text{ m/s}^2$$

$$f_{bk} = 0,6$$

$$\varphi = 20^\circ$$

$$b = 6 \text{ m}$$



$$y = 0 \text{ m}$$

$$p_{vmin} = 0,1 \text{ bar}$$

Fresh water tank in double bottom:

$$h_l = 1,05 \text{ m}$$

$$p_1 = 9,81 \cdot h_1 \cdot \rho \cdot (1 + a_v) + 100 \cdot p_v = 31,74 \text{ kN/m}^2$$

Roll reduction below wheelhouse deck:

$$h_l = 0,9 \text{ m}$$

$$p_1 = 9,81 \cdot \rho \cdot [h_1 \cdot \cos \varphi + (0,3 \cdot b + y) \cdot \sin \varphi] + 100 \cdot p_v = 30,22 \text{ kN/m}^2$$

### 3.4.1.2 Maximum static design pressure

The maximum static design pressure is calculated by:

$$p_2 = 9,81 \cdot h_2, [\text{kN/m}^2]$$

where:

$h_2$  = distance of load centre from top of overflow or from a point 2,5 m above tank top,  
whichever is greater

For tanks equipped with pressure relief valves and/or tanks intended to carry liquids of a density greater than  $1 \text{ t/m}^3$ , the head  $h_2$  is measured to a level at the following distance  $h_p$  above tank top:

$$h_p = 2,5 \cdot \rho, [\text{m}]$$

or

$$h_p = 9,81 \cdot p_v [\text{m}], \text{ where } p_v > 0,25 \cdot \rho.$$

Maximum static design pressure:

$$h_2 = 3,55 \text{ m}$$

$$p_2 = 9,81 \cdot h_2 = 34,83 \text{ kN/m}^2$$

Water tank in double bottom:

$$h_2 = \max(2,5 \cdot \rho, 9,81 \cdot p_v) = 1,11 \text{ m}$$

$$p_2 = 9,81 \cdot h_2 = 10,91 \text{ kN/m}^2$$

Roll reduction below wheelhouse deck:

$$h_2 = \max(2,5 \cdot \rho, 9,81 \cdot p_v) = 0,96 \text{ m}$$

$$p_2 = 9,81 \cdot h_2 = 9,44 \text{ kN/m}^2$$

### 3.4.2 Design pressure for partially filled tanks

#### 3.4.2.1 Tanks partially filled between 20% and 90% of height

The pressure for tanks which may be partially filled between 20% and 90% of their height, the design pressure is not to be taken less than given by the following formulae:

- a) For structures located within  $l_t/4$  from the bulkheads limiting the free liquid surface in the ship's longitudinal direction:

$$p_d = \left(4 - \frac{L}{150}\right) \cdot l_t \cdot \rho \cdot n_x + 100 \cdot p_v, [\text{kn/m}^2],$$

- b) For structures located within  $b_t/4$  from the bulkheads limiting the free liquid surface in the ship's transverse direction:

$$p_d = \left(5,5 - \frac{B}{20}\right) \cdot b_t \cdot \rho \cdot n_y + 100 \cdot p_v, [\text{kn/m}^2],$$

where:

$l_t$  = distance [m] between transverse bulkheads or effective transverse wash bulkheads at the height where the structure is located;

$b_t$  = distance [m] between tank sides or effective longitudinal wash bulkhead at the height where the structure is located;

$$n_x = 1 - \frac{4}{l_t} \cdot x_1;$$

$$n_y = 1 - \frac{4}{b_t} \cdot y_1;$$

$x_1$  = distance [m] of structural element from the tank's ends in the ship's longitudinal direction;

$y_1$  = distance [m] of structural element from the tank's sides in the ship's transverse direction.

$$l_t = 9 \text{ m}$$

$$b_t = 2,4 \text{ m}$$

$$x_1 = 1 \text{ m}$$

$$y_1 = 0,5 \text{ m}$$

$$n_x = 1 - \frac{4}{l_t} \cdot x_1 = 0,56$$

$$n_y = 1 - \frac{4}{b_t} \cdot y_1 = 0,17$$

$$p_d = \left(4 - \frac{L}{150}\right) \cdot l_t \cdot \rho \cdot n_x + 100 \cdot p_v = 27,33 \text{ kN/m}^2$$

$$p_d = \left(5,5 - \frac{B}{20}\right) \cdot b_t \cdot \rho \cdot n_y + 100 \cdot p_v = 11,85 \text{ kN/m}^2$$

### 3.5 Design values of acceleration components

#### 3.5.1 Acceleration components

Following formulae are used to calculate the acceleration components owing to ship's motions:

a) Vertical acceleration (vertical to the base line) due to heave and pitch:

$$a_z = \pm a_0 \sqrt{1 + \left(5,3 - \frac{45}{L}\right)^2 \cdot \left(\frac{x}{L} - 0,45\right)^2 \cdot \left(\frac{0,6}{C_b}\right)^{1,5}}, \text{ [m/s}^2\text{]},$$

b) Transverse acceleration (vertical to the ship's side) due to sway, yaw and roll including gravity component of roll:

$$a_y = \pm a_0 \sqrt{0,6 + 2,5 \cdot \left(\frac{x}{L} - 0,45\right)^2 + k \cdot \left(1 + 0,6 \cdot k \cdot \frac{z-d}{B}\right)^2}, \text{ [m/s}^2\text{]},$$

c) Longitudinal acceleration (in longitudinal direction) due to surge and pitch including gravity component of pitch:

$$a_x = \pm a_0 \sqrt{0,06 + A^2 - 0,25A}, \text{ [m/s}^2\text{]},$$

where:

$a_x, a_y, a_z$  = maximum dimensionless accelerations in the related directions  $x, y$  and  $z$ ;

$$A = \left(0,7 - \frac{L}{1200} + 5 \cdot \frac{z-d}{L}\right) \cdot \frac{0,6}{C_b};$$

$$a_0 = \left(0,2 \cdot \frac{v}{\sqrt{L}} + \frac{3 \cdot C_W \cdot C_L}{L}\right) \cdot f;$$

$$k = 13 \cdot \frac{\overline{GM}}{B};$$

$\overline{GM}$  = metacentric height [m];

$$k_{min} = 1,0;$$

$C_W$  = wave coefficient;

$C_L$  = length coefficient;

$L$  = not to be take less than 100 m;

$f$  = factor depending on probability level  $Q$  outlined in table:

$Q$	$f$
$10^{-8}$	1,000
$10^{-7}$	0,875
$10^{-6}$	0,750
$10^{-5}$	0,625
$10^{-4}$	0,500

$$a_0 = \left(0,2 \cdot \frac{v}{\sqrt{L}} + \frac{3 \cdot C_W \cdot C_L}{L}\right) \cdot f = 0,36 \text{ m/s}^2$$

$$A = \left(0,7 - \frac{L}{1200} + 5 \cdot \frac{z-d}{L}\right) \cdot \frac{0,6}{C_b} = 0,69$$

$$\overline{GM} = 12,95 \text{ m}$$

$$k = 13 \cdot \frac{\overline{GM}}{B} = 8,42$$

Vertical acceleration:

$$a_z(x) = \pm a_0 \sqrt{1 + \left(5,3 - \frac{45}{L}\right)^2 \cdot \left(\frac{x}{L} - 0,45\right)^2 \cdot \left(\frac{0,6}{c_b}\right)^{1,5}}, [\text{m/s}^2],$$

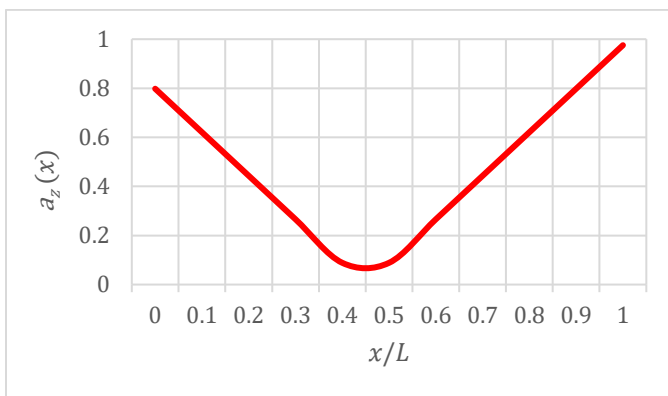

Transverse acceleration:

$$a_y(x, 9,4) = \pm a_0 \sqrt{0,6 + 2,5 \cdot \left(\frac{x}{L} - 0,45\right)^2 + k \cdot \left(1 + 0,6 \cdot k \cdot \frac{z-d}{B}\right)^2}, [\text{m/s}^2],$$

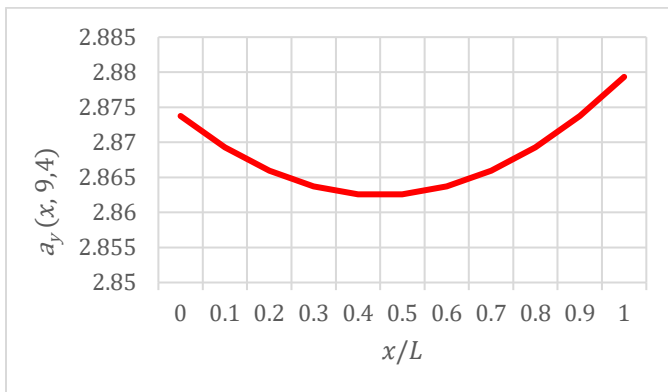

$$a_y(L/2, z) = \pm a_0 \sqrt{0,6 + 2,5 \cdot \left(\frac{x}{L} - 0,45\right)^2 + k \cdot \left(1 + 0,6 \cdot k \cdot \frac{z-d}{B}\right)^2}, [\text{m/s}^2],$$

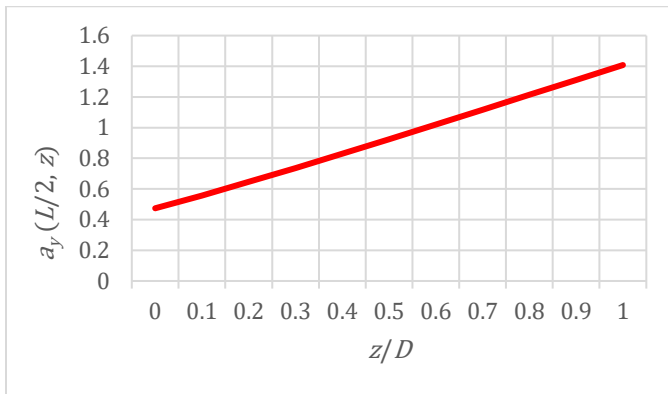

Longitudinal acceleration:

$$a_x(z) = \pm a_0 \sqrt{0,06 + A(z)^2 - 0,25A(z)}, \text{ [m/s}^2\text{]},$$

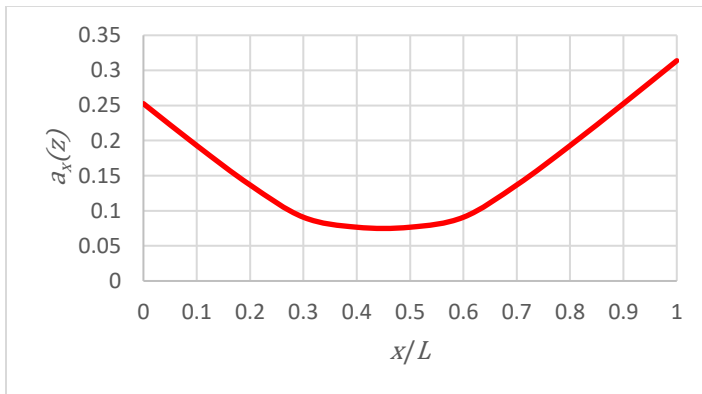

## PRINCIPAL DATA

Length	$L = 92,7 \text{ m}$
Breath moulded	$B = 20 \text{ m}$
Depth moulded	$D = 3,8 \text{ m}$
Draught moulded	$d = 2,5 \text{ m}$
Block coefficient	$C_b = 0,6$
Vessel design velocity	$v = 10 \text{ kn}$
Density of sea water	$\rho = 1,025 \text{ t/m}^3$

## 4 Longitudinal strength

### 4.1 General

#### 4.1.2 Definitions

$M_s$  = still water bending moment [kNm];

$M_w$  = vertical wave bending moment [kNm];

$C_w$  = wave coefficient depending on length;

$F_s$  = still water shear force [kN];

$F_w$  = vertical wave shear force [kN];

$I_y$  = moment of inertia of the transversal section [cm<sup>4</sup>];

$W$  = section modulus of transversal section around the horizontal axis [cm<sup>3</sup>];

$S$  = first moment of the sectional area of the longitudinal members [cm<sup>3</sup>];

$C_b$  = block coefficient;

$v$  = maximum speed of ship at defined shaft revolution and engine power [kn];

$k$  = material factor;

$x$  = distance [m] between aft end of length  $L$  and the position considered;

$H_{sg}, H_{sd}$  = vertical extent of HS steel used in deck bottom [m].

## 4.2 Vertical longitudinal bending moments and shear forces

### 4.2.1 Still water bending moment and shear force

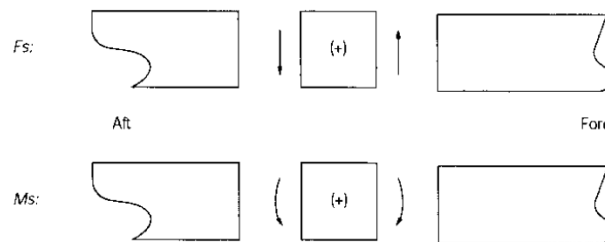

*Sign conventions of  $M_s$  and  $F_s$*

In this case – LC02 maximum cargo, 612 POB, 100% consumables

$$M_s = 38785,3 \text{ kNm}$$

$$F_s = 1382,74 \text{ kN}$$

### 4.2.2 Wave bending moment

The vertical wave bending moments at each section along the ship length are given by the following formulae:

a) hogging condition

$$M_w = +190M \cdot C_w \cdot L^2 \cdot B \cdot C_b \cdot 10^{-3}, [\text{kNm}];$$

b) sagging condition

$$M_w = -110M \cdot C_w \cdot L^2 \cdot B \cdot (C_b + 0,7) \cdot 10^{-3}, [\text{kNm}]$$

where:

$M$  = distribution factor determined according to:

$$M(x) = \begin{cases} 2,5 \cdot \frac{x}{L}, & \text{for } \frac{x}{L} < 0,40 \\ 1,0, & \text{for } 0,4 \leq \frac{x}{L} \leq 0,65, \\ \frac{1-x}{0,35}, & \text{for } \frac{x}{L} > 0,65 \end{cases}$$

$$C_w = 10,75 - \left(\frac{300-L}{100}\right)^{1,5}$$

$C_b$  = not to be taken less than 0,6.

Wave bending moment for ships in limited service conditions may be reduced as follows:

for 40% in navigation area 7 and 8;

for 30% in navigation area 5 and 6;

for 20% in navigation area 3 and 4;

for 10% in navigation area 2.

Wave bending moment for harbour conditions may be multiplied with coefficient 0,1, and for conditions of the off-shore terminal with 0,5.

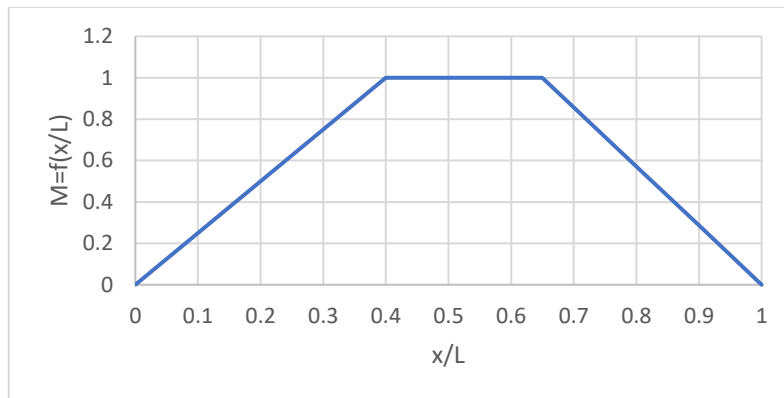

$$C_w = 10,75 - \left(\frac{300-L}{100}\right)^{1,5} = 7,77$$

$$C_b = 0,6$$

$$M_w = +190M \cdot C_w \cdot L^2 \cdot B \cdot C_b \cdot 10^{-3} = 152143,44 \text{ kNm, hogging}$$

$$M_w = -110M \cdot C_w \cdot L^2 \cdot B \cdot (C_b + 0,7) \cdot 10^{-3} = -190846,59 \text{ kNm, sagging}$$

Reduction in navigation area:

$$M_w = 70\% (+190M \cdot C_w \cdot L^2 \cdot B \cdot C_b \cdot 10^{-3}) = 106\,500,41 \text{ kNm, hogging}$$

$$M_w = 70\% [-110M \cdot C_w \cdot L^2 \cdot B \cdot (C_b + 0,7) \cdot 10^{-3}] = -133\,592,61 \text{ kNm, sagging}$$

#### 4.2.3 Wave shear force

The wave shear forces at each section along the ship length are given by the following formulae:

a) positive shear force

$$F_w = +30 F_1 \cdot C_w \cdot L \cdot B \cdot (C_b + 0,7) \cdot 10^{-2}, [\text{kN}];$$

b) negative shear force

$$F_w = -30 F_2 \cdot C_w \cdot L \cdot B \cdot (C_b + 0,7) \cdot 10^{-2}, [\text{kN}]$$

where:

$F_1, F_2$  = distribution factors determined by table:

Range	Positive shear forces ( $F_1$ )	Negative shear forces ( $F_2$ )
$0 \leq \frac{x}{L} < 0,2$	$5 \cdot m \cdot \frac{x}{L}$	$4,6 \cdot \frac{x}{L}$
$0,2 \leq \frac{x}{L} < 0,3$	$m$	0,92
$0,3 \leq \frac{x}{L} < 0,4$	$4 \cdot m - 2,1 + (7 - 10 \cdot m) \cdot \frac{x}{L}$	$1,58 - 2,2 \cdot \frac{x}{L}$
$0,4 \leq \frac{x}{L} < 0,6$	0,7	0,7
$0,6 \leq \frac{x}{L} < 0,7$	$3 \cdot \frac{x}{L} - 1,1$	$4,9 - 6 \cdot m_1 + (10 \cdot m_1 - 7) \cdot \frac{x}{L}$
$0,7 \leq \frac{x}{L} < 0,85$	1,0	$m_1$

where:

$$m = \frac{0,92 \cdot 190 \cdot C_b}{110 \cdot (C_b + 0,7)};$$

$$m_1 = \frac{190 \cdot C_b}{110 \cdot (C_b + 0,7)}.$$

The wave shear forces for harbour and off-shore terminal conditions may be reduced as in 4.2.2.

$$m = \frac{0,92 \cdot 190 \cdot C_b}{110 \cdot (C_b + 0,7)} = 0,733$$

$$m_1 = \frac{190 \cdot C_b}{110 \cdot (C_b + 0,7)} = 0,797$$

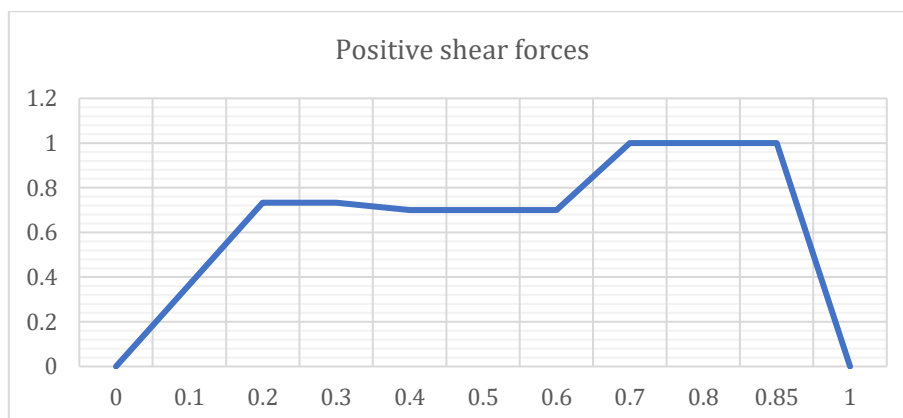



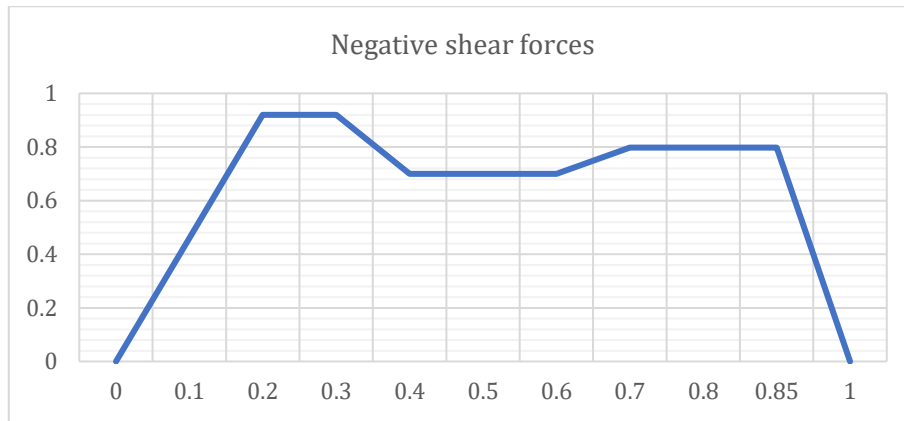

$$F_w(0,5) = +30 F_1 \cdot C_w \cdot L \cdot B \cdot (C_b + 0,7) \cdot 10^{-2} = 3930,35 \text{ kN, positive shear force}$$

$$F_w(0,5) = -30 F_2 \cdot C_w \cdot L \cdot B \cdot (C_b + 0,7) \cdot 10^{-2} = -3930,35 \text{ kN, negative shear force}$$

### 4.3 Bending strength

#### 4.3.2 Section modulus – strength criteria

Hull section modulus is not to be less than the values given by the following formula in way of  $0,4L$  midships for the  $M_s$  given in 4.2.1 and the  $M_w$  given in 4.4.4:

$$W = \frac{|M_s + M_w|}{\sigma} \cdot 10^3, [\text{cm}^3],$$

where:

$\sigma$  = permissible bending stress [N/mm];

$$\text{for } L \geq 90, \sigma(x) = \begin{cases} \left(0,5 + \frac{5}{3} \cdot \frac{x}{L}\right) \cdot \frac{18,5\sqrt{L}}{k}, & \text{for } \frac{x}{L} < 0,3 \\ \frac{175}{k}, & \text{for } 0,3 \leq \frac{x}{L} \leq 0,7 \\ \frac{5}{3} \cdot \left(1,3 - \frac{x}{L}\right) \cdot \frac{18,5\sqrt{L}}{k}, & \text{for } \frac{x}{L} > 0,7 \end{cases} ;$$

$k = 1,0$  for ordinary hull structural steel;

$k < 1$  for higher tensile steel.

$k = 0,72$  for steel with  $ReH = 355 \text{ N/mm}^2$  (AH36)

$$\sigma = \frac{175}{k} = 243,06 \text{ N/mm}$$

$$W_{sagging} = \frac{|M_s + M_w|}{\sigma} \cdot 10^3 = 597\,746,9 \text{ cm}^3$$

$$W_{hogging} = \frac{|M_s + M_w|}{\sigma} \cdot 10^3 = 390\,064,4 \text{ cm}^3$$

#### 4.3.3 Moment of inertia

Moment of inertia of hull section at the midship point is not to be less than:

$$I_{min} = 3 \cdot \frac{L}{k} \cdot W_{min}, [\text{cm}^4].$$

$$I_{min} = 3 \cdot \frac{L}{k} \cdot W_{min} = 3,86 \cdot 10^8 \text{ cm}^4$$

#### 4.3.4 Minimum midship section modulus

The minimum midship section modulus a deck and keel for ships  $90 \text{ m} \leq L \leq 500 \text{ m}$  is:

$$W_{min} = C_w \cdot L^2 \cdot B \cdot (C_b + 0,7) \cdot k, [\text{cm}^3].$$

Minimum midship section modulus for ships in limited service conditions may be reduced as follows:

5% for navigation area 2;

15% for navigation area 3;

20% for navigation area 4 and 5;

25% for navigation area 6, 7 and 8.

$$W_{min} = C_w \cdot L^2 \cdot B \cdot (C_b + 0,7) \cdot k = 1,25 \cdot 10^6 \text{ cm}^3$$

$$W_{min, reduced} = 80\% [C_w \cdot L^2 \cdot B \cdot (C_b + 0,7) \cdot k] = 9,99 \cdot 10^5 \text{ cm}^3$$

Section modulus at deck

$$W_d = 3,65 \cdot 10^6 \text{ cm}^3$$

Section modulus at bottom

$$W_b = 1,76 \cdot 10^6 \text{ cm}^3$$

$$s_d = \frac{W_d}{W_{min}} = 3,66$$

$$s_b = \frac{W_b}{W_{min}} = 1,77$$

### 4.4 Shearing strength

#### 4.4.2 Calculation of shear stresses

For ships without longitudinal bulkheads and with two longitudinal bulkheads the shear stress distribution in the side shell and in the longitudinal bulkheads is determined by:

$$\tau = \frac{(F_s + F_w) \cdot S}{I_y \cdot t} \cdot (0,5 - \Phi) \cdot 10^2, [\text{N/mm}^2]$$

where:

$S$  = first moment [cm<sup>3</sup>] of the area of the effective longitudinal members between the vertical level at which the shear stress is being determined and the vertical extremity of effective longitudinal members, taken at the section under consideration;

$t$  = thickness of side shell or longitudinal bulkhead plating [mm] at the section considered;

$\Phi = 0$  for ships without longitudinal bulkhead;

= where two longitudinal bulkheads are fitted:

for the side shell:

$$\Phi = 0,34 - 0,08 \cdot \frac{A_S}{A_L};$$

for the longitudinal bulkheads:

$$\Phi = 0,16 + 0,08 \cdot \frac{A_S}{A_L},$$

$A_S$  = sectional area of side shell plating [cm<sup>2</sup>] within the depth D;

$A_L$  = sectional area of longitudinal bulkhead plating [cm<sup>2</sup>] within the depth D.

$$S = 5,71 \cdot 10^6 \text{ cm}^2$$

$$A_S = 5,38 \cdot 10^5 \text{ cm}^2$$

$$A_L = 9,25 \cdot 10^5 \text{ cm}^2$$

$$\Phi_{SS} = 0,34 - 0,08 \cdot \frac{A_S}{A_L} = 0,202$$

$$\Phi_{LB} = 0,16 + 0,08 \cdot \frac{A_S}{A_L} = 0,298$$

$$I_y = 4,52 \cdot 10^8 \text{ cm}^4$$

$$t = 14 \text{ mm}$$

$$\tau_{SS,positive} = \frac{(F_S + F_W) \cdot S}{I_y \cdot t} \cdot (0,5 - \Phi_{SS}) \cdot 10^2 = 113,36 \text{ N/mm}^2$$

$$\tau_{SS,negative} = \frac{(F_S + F_W) \cdot S}{I_y \cdot t} \cdot (0,5 - \Phi_{SS}) \cdot 10^2 = -95,00 \text{ N/mm}^2$$

$$\tau_{LB,positive} = \frac{(F_S + F_W) \cdot S}{I_y \cdot t} \cdot (0,5 - \Phi_{LB}) \cdot 10^2 = 106,53 \text{ N/mm}^2$$

$$\tau_{LB,negative} = \frac{(F_S + F_W) \cdot S}{I_y \cdot t} \cdot (0,5 - \Phi_{LB}) \cdot 10^2 = -64,63 \text{ N/mm}^2$$

$$\tau_{permissible} = \frac{110}{k} = 152,78 \text{ N/mm}^2$$

## 4.5 Additional bending moments

### 4.5.1 Additional bending moments due to slamming loads in the forebody region

The additional bending moment due to slamming loads in the forebody region is approximately determined by the following formula:

$$M_{SL} = w \cdot L^4 \cdot B \cdot n_1 \cdot n_2 \cdot n_3 \cdot M_1 \cdot 10^{-5}, [\text{kNm}],$$

where:

$$w = 1,4 \text{ hogging condition};$$

$$w = -2,2 \text{ sagging condition};$$

$$n_1 = \frac{b_1 - b_2}{1,2 \cdot (D - d_1)} - 1, n_1 \geq 0;$$

$$b_1 = \text{breadth of the uppermost continuous deck [m] at } \frac{x}{L} = 0,8;$$

$$b_2 = \text{breadth of the waterline [m] at } \frac{x}{L} = 0,8;$$

$$d_1 = \text{draft of the actual loading ballast condition [m];}$$

$$n_2 = 1 - \frac{(145 - L)^2}{1225}, n_2 \geq 0;$$

$$n_3 = 0,33 + 0,67 \cdot \frac{v}{1,6 \cdot \sqrt{L}}, n_3 \geq 0;$$

$M_1$  = distribution factor

$$M_1 = \begin{cases} 2,5 \cdot \frac{x}{L}, & \text{for } \frac{x}{L} < 0,4 \\ 1,0, & \text{for } 0,4 \leq \frac{x}{L} \leq 0,8 \\ 5 \left(1 - \frac{x}{L}\right), & \text{for } \frac{x}{L} > 0,8 \end{cases}$$

$$n_1 = \frac{b_1 - b_2}{1,2 \cdot (D - d_1)} - 1 = 3,69$$

$$n_2 = 1 - \frac{(145 - L)^2}{1225} = 1,23$$

$$n_3 = 0,33 + 0,67 \cdot \frac{v}{1,6 \cdot \sqrt{L}} = 0,55$$

$$M_1 = 1$$

$$M_{SL} = w \cdot L^4 \cdot B \cdot n_1 \cdot n_2 \cdot n_3 \cdot M_1 \cdot 10^{-5} = 52033,82 \text{ kNm}$$

#### 4.5.3 Design stress $\sigma_L$

In design hull girder bending stress it calculated by the following formula:

$$\sigma_L = \frac{|M_S| + 0,75 \cdot |M_W| + |M_{SL}|}{W} \cdot 10^3, [\text{N/mm}^2],$$

where:

$$W = W_{d(a)} \text{ or } W_{b(a)} \text{ for deck or bottom according to 4.3.1 [cm}^3\text{].}$$

$$\sigma_L = \frac{|M_S| + 0,75 \cdot |M_W| + |M_{SL}|}{W} \cdot 10^3 = 285,56 \text{ N/mm}^2$$

## 4.6 Buckling strength

### 4.6.2 Elastic buckling stresses

#### 4.6.2.1 Elastic buckling of plates

##### 4.6.2.1.1 Compression

The ideal elastic buckling stress is given by:

$$\sigma_E = 0,9 mE \left( \frac{t_b}{1000 \cdot b} \right)^2, \text{ [N/mm}^2\text{]},$$

a) For plating with longitudinal stiffeners (parallel to compressive stress):

$$m = \frac{8,4}{\psi+1,1}, \text{ buckling factor } 0 \leq \psi \leq 1;$$

b) For plating with transverse stiffeners (perpendicular to compressive stress):

$$m = c \left[ 1 + \left( \frac{b}{a} \right)^2 \right]^2 \cdot \frac{2,1}{\psi+1,1}, \text{ buckling factor } 0 \leq \psi \leq 1;$$

c) For same load cases of plates

$m$  given in Table 4.6.2.1-2 and 4.6.2.1-3.

where:

$E$  = modulus of elasticity of material [N/mm<sup>2</sup>];

$E = 2,06 \cdot 10^5$  N/mm<sup>2</sup> for shipbuilding steel;

$t_b$  = net thickness [mm] of plating, considering standard deductions equal to the values given in the table 4.6.2.1-1;

$b$  = shorter side of plate panel [m];

$a$  = longer side of plate panel [m];

$c$  = correction factor;

$c = 1,00$  for stiffeners sniped at both ends;

$c = 1,30$  when plating stiffened by floors or deep girders;

$c = 1,21$  when stiffeners are angles or T-sections;

$c = 1,10$  when stiffeners are bulb bars;

$c = 1,05$  when stiffeners are flat bars;

$\psi$  = ratio between smallest and largest compressive  $\sigma_a$  stress when linear variation across panel.

**Table 4.6.2.1-1**

Structure	Standard deduction [mm]	Limit values min-max [mm]
<ul style="list-style-type: none"> <li>- compartments carrying dry bulk cargoes</li> <li>- one side exposure to ballast and/or liquid cargo</li> <li>- vertical surfaces and surfaces sloped at an angle greater than 25° to the horizontal line</li> </ul>	0,05t	0,5 ÷ 1
<ul style="list-style-type: none"> <li>- one side exposure to ballast and/or liquid cargo</li> <li>- horizontal surfaces and surfaces sloped at an angle less than 25° to the horizontal line</li> <li>- two side exposure to ballast and/or liquid cargo</li> <li>- vertical surfaces and surfaces sloped at an angle greater than 25° to the horizontal line</li> </ul>	0,1t	2 ÷ 3
<ul style="list-style-type: none"> <li>- two side exposure to ballast and/or liquid cargo</li> <li>- horizontal surfaces and surfaces sloped at an angle less than 25° to the horizontal line</li> </ul>	0,15t	2 ÷ 4

**Table 4.6.2.1-2**

Load case	Buckling factor	Load case	Buckling factor
	$m = \frac{8,4}{\psi + 1,1}$		<p>for <math>(a - d_a) \geq (b - d_b)</math>:</p> $k_t = \left(1 - \frac{d_b}{b}\right) \left[5,34 + 4 \left(\frac{b}{a}\right)^2\right]$ <p>for <math>(a - d_a) &lt; (b - d_b)</math>:</p> $k_t = \left(1 - \frac{d_a}{a}\right) \left[5,34 + 4 \left(\frac{b}{a}\right)^2\right]$
	$m = c \cdot \left[1 + \left(\frac{b}{a}\right)^2\right]^2 \cdot \frac{2,1}{\psi + 1,1}$		$m = 1,28$
	$m = \frac{1,333 \cdot \left[0,425 + \left(\frac{b}{a}\right)^2\right]}{\psi + 0,333}$		$m = 6,97$
	$m = \left[0,425 + \left(\frac{b}{a}\right)^2\right] (1,5 - 0,5\psi)$		$m = 4 + \left[\frac{4 - \frac{b}{a}}{3}\right]^4 \cdot 2,74$
	$k_t = 5,34 + 4 \cdot \left(\frac{b}{a}\right)^2$		$m = 6,97 + \left[\frac{4 - \frac{b}{a}}{3}\right]^4 \cdot 3,1$

Table 4.6.2.1-3

Load case	Aspect ratio $b/R$	Buckling factor
 <p>1a</p>	$\frac{b}{R} \leq 1,63 \sqrt{\frac{R}{t}}$	$m = \frac{b}{\sqrt{R \cdot t}} + 3 \cdot \frac{(R \cdot t)^{0,175}}{b^{0,35}}$
 <p>with</p> <p><math>\sigma_x = \frac{p_e \cdot R}{t}</math></p> <p><math>p_e</math></p> <p><math>p_e = \text{external pressure in [N/mm}^2\text{]}</math></p>	$\frac{b}{R} > 1,63 \sqrt{\frac{R}{t}}$	$m = 0,3 \frac{b^2}{R^2} + 2,25 \left( \frac{R^2}{b \cdot t} \right)^2$
 <p>2</p>	$\frac{b}{R} \leq 0,5 \sqrt{\frac{R}{t}}$ $\frac{b}{R} > 0,5 \sqrt{\frac{R}{t}}$	$m = 1 + \frac{2}{3} \frac{b^2}{R \cdot t}$ $m = 0,267 \frac{b^2}{R \cdot t} \left[ 3 - \frac{b}{R} \sqrt{\frac{t}{R}} \right] \geq 0,4 \frac{b^2}{R \cdot t}$
 <p>3</p>	$\frac{b}{R} \leq \sqrt{\frac{R}{t}}$ $\frac{b}{R} > \sqrt{\frac{R}{t}}$	$m = \frac{0,6 \cdot b}{\sqrt{R \cdot t}} + \frac{\sqrt{R \cdot t}}{b} - 0,3 \frac{R \cdot t}{b^2}$ $m = 0,3 \frac{b^2}{R^2} + 0,291 \left( \frac{R^2}{b \cdot t} \right)^2$
 <p>4</p>	$\frac{b}{R} \leq 8,7 \sqrt{\frac{R}{t}}$ $\frac{b}{R} > 8,7 \sqrt{\frac{R}{t}}$	$m = k_t \cdot \sqrt{3}$ $k_t = \left[ 28,3 \cdot \frac{0,67 \cdot b^3}{(R \cdot t)^{1,5}} \right]^{0,5}$ $k_t = 0,28 \cdot \frac{b^2}{R \sqrt{R \cdot t}}$

Plate	$z_1$	$z_2$	$y_1$	$y_2$	$\sigma_0, h$	$\sigma_{a2}, h$	$\sigma_0, s$	$\sigma_{a2}, s$	$\psi$	$c_1$	$c_2$	$m$	$t$	$\sigma_c$	$\sigma_c$	$\sigma_c \geq \beta \sigma_a$
1	0,000	0,000	2,563	2,563	82,36	82,36	-53,75	-53,75	1,00	1,21	1,05	4,00	10,5	227,115	174,2103	TRUE
2	0,000	0,000	2,563	2,563	82,36	82,36	-53,75	-53,75	1,00	1,05	1,05	4,00	10,5	227,115	174,2103	TRUE
3	0,000	0,000	2,563	2,563	82,36	82,36	-53,75	-53,75	1,00	1,05	1,05	4,00	10,5	227,115	174,2103	TRUE
4	0,000	0,000	2,563	2,563	82,36	82,36	-53,75	-53,75	1,00	1,05	1,05	4,00	10,5	227,115	174,2103	TRUE
5	0,000	0,000	2,563	2,563	82,36	82,36	-53,75	-53,75	1,00	1,05	1,21	4,00	10,5	227,115	174,2103	TRUE
6	0,000	0,000	2,563	2,563	82,36	82,36	-53,75	-53,75	1,00	1,21	1,05	4,00	10,5	227,115	174,2103	TRUE
7	0,000	0,000	2,563	2,563	82,36	82,36	-53,75	-53,75	1,00	1,05	1,05	4,00	10,5	227,115	174,2103	TRUE
8	0,000	0,000	2,563	2,563	82,36	82,36	-53,75	-53,75	1,00	1,05	1,05	4,00	10,5	227,115	174,2103	TRUE
9	0,000	0,000	2,563	2,563	82,36	82,36	-53,75	-53,75	1,00	1,05	1,05	4,00	10,5	227,115	174,2103	TRUE
10	0,000	0,006	2,563	2,557	82,36	82,17	-53,75	-53,62	1,00	1,05	1,21	4,00	10,5	227,368	174,2781	TRUE
11	0,006	0,090	2,557	2,473	82,17	79,47	-53,62	-51,86	0,97	1,21	1,05	4,06	10,5	230,724	175,1613	TRUE
12	0,090	0,291	2,473	2,272	79,47	73,01	-51,86	-47,64	0,92	1,05	1,1	4,16	10,5	236,259	176,5631	TRUE
13	0,291	0,624	2,272	1,939	73,01	62,31	-47,64	-40,66	0,85	1,1	1,1	4,30	10,5	244,156	178,4531	TRUE
14	0,624	1,023	1,939	1,540	62,31	49,49	-41,67	-41,67	0,79	1,1	1,1	4,43	10,5	251,787	180,167	TRUE
15	1,023	1,421	1,540	1,142	49,49	36,70	-41,67	-41,67	0,74	1,1	1,1	4,56	10,5	258,988	181,6915	TRUE
16	1,421	1,820	1,142	0,743	41,67	41,67	-41,67	-41,67	1,00	1,1	1,1	4,00	10,5	227,115	174,2103	TRUE
17	1,820	2,426	0,743	0,137	41,67	41,67	-41,67	-41,67	1,00	1,1	1,1	4,00	10,5	227,115	174,2103	TRUE
18	2,426	3,188	0,137	0,625	41,67	41,67	-41,67	-41,67	1,00	1,1	1,1	4,00	10,5	227,115	174,2103	TRUE
19	3,188	3,800	0,625	1,237	41,67	41,67	-41,67	-41,67	1,00	1,1	1,21	4,00	10,5	227,115	174,2103	TRUE
20	1,050	1,050	1,513	1,513	48,62	48,62	-41,67	-41,67	1,00	1,21	1,1	4,00	8	131,840	131,84	TRUE
21	1,050	1,050	1,513	1,513	48,62	48,62	-41,67	-41,67	1,00	1,1	1,1	4,00	8	131,840	131,84	TRUE
22	1,050	1,050	1,513	1,513	48,62	48,62	-41,67	-41,67	1,00	1,1	1,1	4,00	8	131,840	131,84	TRUE
23	1,050	1,050	1,513	1,513	48,62	48,62	-41,67	-41,67	1,00	1,1	1,1	4,00	8	131,840	131,84	TRUE
24	1,050	1,050	1,513	1,513	48,62	48,62	-41,67	-41,67	1,00	1,1	1,21	4,00	8	131,840	131,84	TRUE
25	1,050	1,050	1,513	1,513	48,62	48,62	-41,67	-41,67	1,00	1,21	1,1	4,00	8	131,840	131,84	TRUE
26	1,050	1,050	1,513	1,513	48,62	48,62	-41,67	-41,67	1,00	1,1	1,1	4,00	8	131,840	131,84	TRUE
27	1,050	1,050	1,513	1,513	48,62	48,62	-41,67	-41,67	1,00	1,1	1,1	4,00	8	131,840	131,84	TRUE
28	1,050	1,050	1,513	1,513	48,62	48,62	-41,67	-41,67	1,00	1,1	1,1	4,00	8	131,840	131,84	TRUE
29	1,050	1,050	1,513	1,513	48,62	48,62	-41,67	-41,67	1,00	1,1	1,21	4,00	8	131,840	131,84	TRUE
30	0,000	1,050	2,563	1,513	82,36	48,62	-53,75	-31,73	0,59	1,3	1,3	4,97	12	368,535	197,5375	TRUE
31	0,000	1,050	2,563	1,513	82,36	48,62	-53,75	-31,73	0,59	1,3	1,3	4,97	12	368,535	197,5375	TRUE
32	0,006	1,050	2,557	1,513	82,17	48,62	-53,62	-31,73	0,59	1,3	1,3	4,97	12	368,234	197,5068	TRUE
33	1,050	1,750	1,513	0,813	48,62	26,13	-41,67	-41,67	0,54	1,3	1,1	5,13	7	129,462	129,4622	TRUE
34	1,750	2,450	0,813	0,113	41,67	41,67	-41,67	-41,67	1,00	1,1	1,1	4,00	7	100,940	100,94	TRUE
35	2,450	3,200	0,113	0,637	41,67	41,67	-41,67	-41,67	1,00	1,1	1,1	4,00	7	100,940	100,94	TRUE
36	3,200	3,800	0,637	1,237	41,67	41,67	-41,67	-41,67	1,00	1	1,3	4,00	10	206,000	167,9794	TRUE
37	3,200	3,800	0,637	1,237	41,67	41,67	-41,67	-41,67	1,00	1,1	1,3	4,00	10	206,000	167,9794	TRUE
38	3,800	3,800	1,237	1,237	41,67	41,67	-41,67	-41,67	1,00	1,21	1,1	4,00	9	166,860	166,86	TRUE
39	3,800	3,800	1,237	1,237	41,67	41,67	-41,67	-41,67	1,00	1,1	1,1	4,00	9	166,860	166,86	TRUE
40	3,800	3,800	1,237	1,237	41,67	41,67	-41,67	-41,67	1,00	1,1	1,1	4,00	9	166,860	166,86	TRUE
41	3,800	3,800	1,237	1,237	41,67	41,67	-41,67	-41,67	1,00	1,1	1,1	4,00	9	166,860	166,86	TRUE
42	3,800	3,800	1,237	1,237	41,67	41,67	-41,67	-41,67	1,00	1,1	1,1	4,00	9	166,860	166,86	TRUE
43	3,800	3,800	1,237	1,237	41,67	41,67	-41,67	-41,67	1,00	1,1	1,1	4,00	9	166,860	166,86	TRUE
44	3,800	3,800	1,237	1,237	41,67	41,67	-41,67	-41,67	1,00	1,1	1,1	4,00	9	166,860	166,86	TRUE
45	3,800	3,800	1,237	1,237	41,67	41,67	-41,67	-41,67	1,00	1,1	1,1	4,00	9	166,860	166,86	TRUE
46	3,800	3,800	1,237	1,237	41,67	41,67	-41,67	-41,67	1,00	1,1	1,1	4,00	9	166,860	166,86	TRUE
47	3,800	3,800	1,237	1,237	41,67	41,67	-41,67	-41,67	1,00	1,1	1,21	4,00	9	166,860	166,86	TRUE
48	3,800	3,800	1,237	1,237	41,67	41,67	-41,67	-41,67	1,00	1,21	1,1	4,00	9	166,860	166,86	TRUE
49	3,800	3,800	1,237	1,237	41,67	41,67	-41,67	-41,67	1,00	1,1	1,1	4,00	9	166,860	166,86	TRUE
50	3,800	3,800	1,237	1,237	41,67	41,67	-41,67	-41,67	1,00	1,1	1,1	4,00	9	166,860	166,86	TRUE
51	3,800	3,800	1,237	1,237	41,67	41,67	-41,67	-41,67	1,00	1,1	1,1	4,00	9	166,860	166,86	TRUE
52	3,800	3,800	1,237	1,237	41,67	41,67	-41,67	-41,67	1,00	1,1	1,1	4,00	9	166,860	166,86	TRUE
53	3,800	3,800	1,237	1,237	41,67	41,67	-41,67	-41,67	1,00	1,1	1,1	4,00	9	166,860	166,86	TRUE
54	3,800	3,800	1,237	1,237	41,67	41,67	-41,67	-41,67	1,00	1,1	1,3	4,00	9	166,860	166,86	TRUE
55	3,800	4,500	1,237	1,937	41,67	62,25	-41,67	-41,67	0,67	1,3	1,1	4,75	8	156,469	133,3348	TRUE
56	4,500	5,200	1,937	2,637	62,25	84,74	-41,67	-55,30	0,73	1,1	1,1	4,58	7	115,546	115,5457	TRUE
57	5,200	5,900	2,637	3,337	84,74	107,23	-55,30	-69,98	0,79	1,1	1,1	4,44	7	112,142	112,1419	TRUE
58	5,900	6,600	3,337	4,037	107,23	129,73	-69,98	-84,66	0,83	1,1	1,1	4,36	7	110,025	110,0247	TRUE
59	6,600	7,300	4,037	4,737	129,73	152,22	-84,66	-99,33	0,85	1,1	1,1	4,30	7	108,581	108,5806	TRUE

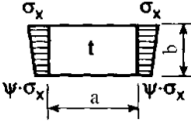
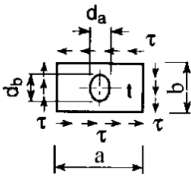
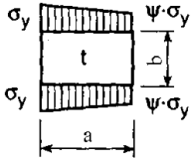
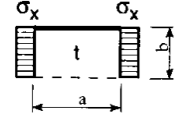
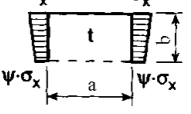
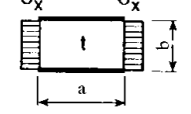
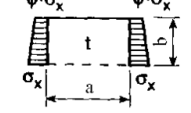
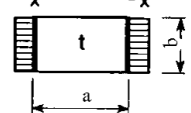
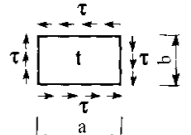
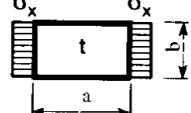

Plate	$z_1$	$z_2$	$y_1$	$y_2$	$\sigma_a, h$	$\sigma_{a2}, h$	$\sigma_a, s$	$\sigma_{a2}, s$	$\psi$	$c_1$	$c_2$	$m$	$t$	$\sigma_c$	$\sigma_c$	$\sigma_c \geq \beta \sigma_a$
60	7,300	8,000	4,737	5,437	152,22	174,72	-99,33	-114,01	0,87	1,1	1,1	4,26	7	107,533	107,5326	TRUE
61	8,000	8,700	5,437	6,137	174,72	197,21	-114,01	-128,69	0,89	1,1	1,1	4,23	8	139,412	139,4122	TRUE
62	8,700	9,400	6,137	6,837	197,21	219,71	-128,69	-143,37	0,90	1,1	1,3	4,21	8	138,597	138,5972	TRUE
63	8,830	9,450	6,267	6,887	201,39	221,31	-131,42	-144,42	0,91	1	1,3	4,18	8	137,745	137,745	FALSE
64	8,830	9,450	6,267	6,887	201,39	221,31	-131,42	-144,42	0,91	1	1,3	4,18	8	137,745	137,745	FALSE
65	9,450	9,450	6,887	6,887	221,31	221,31	-144,42	-144,42	1,00	1,3	1,1	4,00	6	74,160	74,16	FALSE
66	9,450	9,450	6,887	6,887	221,31	221,31	-144,42	-144,42	1,00	1,1	1,1	4,00	6	74,160	74,16	FALSE
67	9,450	9,450	6,887	6,887	221,31	221,31	-144,42	-144,42	1,00	1,1	1,1	4,00	6	74,160	74,16	FALSE
68	9,450	9,450	6,887	6,887	221,31	221,31	-144,42	-144,42	1,00	1,1	1,21	4,00	6	74,160	74,16	FALSE
69	9,450	9,450	6,887	6,887	221,31	221,31	-144,42	-144,42	1,00	1,21	1,1	4,00	6	74,160	74,16	FALSE
70	9,450	9,450	6,887	6,887	221,31	221,31	-144,42	-144,42	1,00	1,1	1,1	4,00	6	74,160	74,16	FALSE
71	9,450	9,450	6,887	6,887	221,31	221,31	-144,42	-144,42	1,00	1,1	1,1	4,00	6	74,160	74,16	FALSE
72	9,450	9,450	6,887	6,887	221,31	221,31	-144,42	-144,42	1,00	1,1	1,1	4,00	6	74,160	74,16	FALSE
73	9,450	9,450	6,887	6,887	221,31	221,31	-144,42	-144,42	1,00	1,1	1,1	4,00	6	74,160	74,16	FALSE
74	9,450	9,450	6,887	6,887	221,31	221,31	-144,42	-144,42	1,00	1,1	1,1	4,00	6	74,160	74,16	FALSE
75	9,450	9,450	6,887	6,887	221,31	221,31	-144,42	-144,42	1,00	1,1	1,21	4,00	6	74,160	74,16	FALSE
76	9,441	9,450	6,878	6,887	221,02	221,31	-144,23	-144,42	1,00	1,21	1,1	4,00	8	131,922	131,9221	FALSE
77	9,432	9,441	6,869	6,878	220,74	221,02	-144,04	-144,23	1,00	1,1	1,1	4,00	8	131,922	131,9222	FALSE
78	9,423	9,432	6,860	6,869	220,45	220,74	-143,85	-144,04	1,00	1,1	1,1	4,00	8	131,922	131,9223	FALSE
79	9,415	9,423	6,852	6,860	220,19	220,45	-143,69	-143,85	1,00	1,1	1,1	4,00	8	131,913	131,9133	FALSE
80	9,407	9,415	6,844	6,852	219,93	220,19	-143,52	-143,69	1,00	1,1	1,1	4,00	8	131,913	131,9133	FALSE
81	9,400	9,407	6,837	6,844	219,71	219,93	-143,37	-143,52	1,00	1,1	1,3	4,00	8	131,904	131,9042	FALSE
82	11,800	12,250	9,237	9,687	296,83	311,29	-193,70	-203,14	0,95	1	1,3	4,09	7	103,223	103,2234	FALSE
83	11,800	12,200	9,237	9,637	296,83	309,69	-193,70	-202,09	0,96	1	1,3	4,08	7	102,975	100,9266	FALSE
84	11,800	12,250	9,237	9,687	296,83	311,29	-193,70	-203,14	0,95	1	1,3	4,09	7	103,223	101,2488	FALSE
85	12,250	12,250	9,687	9,687	311,29	311,29	-203,14	-203,14	1,00	1,3	1,1	4,00	6	74,160	48,83158	FALSE
86	12,250	12,250	9,687	9,687	311,29	311,29	-203,14	-203,14	1,00	1,1	1,1	4,00	6	74,160	48,83158	FALSE
87	12,250	12,250	9,687	9,687	311,29	311,29	-203,14	-203,14	1,00	1,1	1,1	4,00	6	74,160	48,83158	FALSE
88	12,250	12,250	9,687	9,687	311,29	311,29	-203,14	-203,14	1,00	1,1	1,21	4,00	6	74,160	48,83158	FALSE
89	12,250	12,250	9,687	9,687	311,29	311,29	-203,14	-203,14	1,00	1,21	1,1	4,00	6	74,160	48,83158	FALSE
90	12,250	12,250	9,687	9,687	311,29	311,29	-203,14	-203,14	1,00	1,1	1,1	4,00	6	74,160	48,83158	FALSE
91	12,250	12,250	9,687	9,687	311,29	311,29	-203,14	-203,14	1,00	1,1	1,1	4,00	6	74,160	48,83158	FALSE
92	12,250	12,250	9,687	9,687	311,29	311,29	-203,14	-203,14	1,00	1,1	1,1	4,00	6	74,160	48,83158	FALSE
93	12,250	12,250	9,687	9,687	311,29	311,29	-203,14	-203,14	1,00	1,1	1,1	4,00	6	74,160	48,83158	FALSE
94	12,250	12,250	9,687	9,687	311,29	311,29	-203,14	-203,14	1,00	1,1	1,1	4,00	6	74,160	48,83158	FALSE
95	12,250	12,250	9,687	9,687	311,29	311,29	-203,14	-203,14	1,00	1,1	1,21	4,00	6	74,160	48,83158	FALSE
96	12,241	12,250	9,678	9,687	311,00	311,29	-202,95	-203,14	1,00	1,21	1,1	4,00	6	74,193	48,91394	FALSE
97	12,232	12,241	9,669	9,678	310,71	311,00	-202,76	-202,95	1,00	1,1	1,1	4,00	6	74,193	48,91402	FALSE
98	12,224	12,232	9,661	9,669	310,46	310,71	-202,59	-202,76	1,00	1,1	1,1	4,00	6	74,189	48,90493	FALSE
99	12,215	12,224	9,652	9,661	310,17	310,46	-202,40	-202,59	1,00	1,1	1,1	4,00	6	74,193	48,91417	FALSE
100	12,207	12,215	9,644	9,652	309,91	310,17	-202,23	-202,40	1,00	1,1	1,1	4,00	6	74,189	48,90506	FALSE
101	12,200	12,207	9,637	9,644	309,69	309,91	-202,09	-202,23	1,00	1,1	1	4,00	6	74,186	48,89593	FALSE

## 5. Shell plating

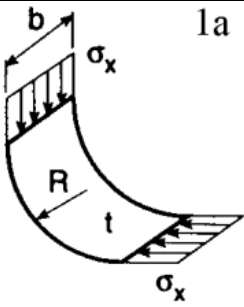
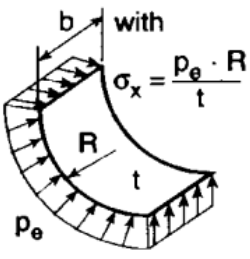
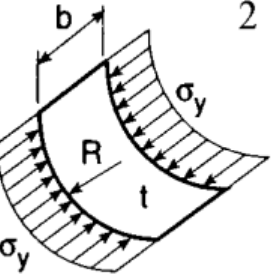
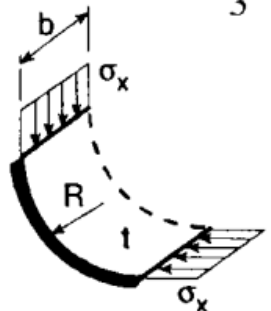
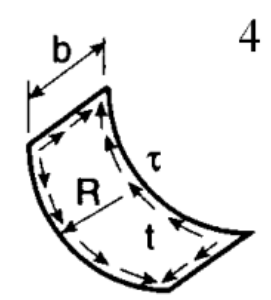
### 5.1 General

#### 5.1.2 Definitions

Following definitions are used:

$k$  = material factor;

$p_B$  = load on bottom [kN/m<sup>2</sup>] according to 3.2.3;

$p_s$  = load on sides [kN/m<sup>2</sup>] according to 3.2.2.1;

$p_e$  = design pressure for the bow area [kN/m<sup>2</sup>] according to 3.2.2.2;

$p_{SL}$  = design slamming pressure [kN/m<sup>2</sup>] according to 3.2.4;

$n_l$  = 1,0 for transverse framing;

$n_l$  = 0,83 for longitudinal framing;

$\sigma_L$  = maximum hull girder bending stress [N/mm<sup>2</sup>] for calculating stress and for fatigue analysis at the considered station is given by the following formula:

$$\sigma_L = \frac{|M_S| + 0,75 \cdot |M_W| + |M_{SL}|}{W} \cdot 10^3, [\text{N/mm}^2]$$

where:

$W$  =  $W_d$  or  $W_b$  section modulus at deck or bottom [cm<sup>3</sup>];

$\tau_L$  = maximum design shear stress due to longitudinal hull girder bending [N/mm<sup>2</sup>]

where the wave shear force may be taken as  $0,75F_w$ ;

$\sigma_{dop}$  = permissible design stress [N/mm<sup>2</sup>];

$$\sigma_{dop} = \left[ 0,8 + \frac{L}{450} \right] \cdot \frac{230}{k} \text{ for } L < 90 \text{ m};$$

$$\sigma_{dop} = \frac{230}{k} \text{ for } L \geq 90 \text{ m};$$

$t_k$  = corrosion addition [mm];

$t_k$  = 1,5 mm for  $t \leq 10$  mm;

$$t_k = \frac{0,1 \cdot t}{\sqrt{k}} + 0,5 [\text{mm}], \text{ max. } 3,0 \text{ mm, for } t > 10 \text{ mm.}$$

$$L = 92,635 \text{ m}$$

$$k = 0,72$$

$$p_B = 38,62 \text{ kN/m}^2$$

$$p_s = 34,36 \text{ kN/m}^2$$

$$\sigma_L = \frac{|M_S| + 0,75 \cdot |M_W| + |M_{SL}|}{W} \cdot 10^3 = 155,84 \text{ N/mm}^2$$

$$\sigma_{dop} = \frac{230}{k} = 319,44 \text{ N/mm}^2$$

$$n_l = 0,83$$

$$s = 0,6 \text{ m}$$

## 5.2 Bottom plating

### 5.2.1 Plating within 0,4 L amidships

#### 5.2.1.1 Ships of $L \geq 90$ m

The thickness of the bottom plating is not to be less than the following two values:

$$t_1 = 18,3 \cdot n_1 \cdot s \cdot \sqrt{\frac{p_B}{\sigma_a}} + t_k, [\text{mm}],$$

$$t_2 = 1,21 \cdot s \cdot \sqrt{p_B \cdot k} + t_k, [\text{mm}],$$

where:

$$\sigma_a = \sqrt{\sigma_{dop}^2 - 3 \cdot \tau_L^2} - 0,89 \cdot \sigma_L, [\text{N/mm}^2];$$

$$\sigma_L = \frac{120}{k} [\text{N/mm}^2] \text{ for } L \geq 90 \text{ m};$$

$$\tau_L = 0;$$

$$s = \text{stiffener's spacing [m]}.$$

### 5.2.2 Critical plate thickness

For ships, for which proof of longitudinal strength is carried out, the thickness is not to be less than:

$$t_{krit} = c_1 \cdot 2,32 \cdot s \cdot \sqrt{\sigma_L} + t_k, [\text{mm}],$$

where:

$$c_1 = 0,5 \text{ for longitudinal framing};$$

$$c_1 = \frac{1}{(1+\alpha^2) \cdot \sqrt{c}} \text{ for transverse framing};$$

$$\alpha = \text{aspect ratio of plate panel considered};$$

$$\alpha = \frac{s}{l};$$

$$c = \text{according to 4.6.2.1.1};$$

$$c = 0,1 \text{ for longitudinal framing};$$

$$\sigma_L = \text{according to 5.1.2};$$

$$s = \text{stiffener's spacing [m]}.$$

$$l = \text{larger side of panel [m]}.$$

Plate	$t_1$ [mm]	$t_2$ [mm]	$t_k$ [mm]	$t_{krit}$ [mm]	chosen thickness [mm]
1	6,029	5,566	1,737	10,426	10,5
2	6,029	5,566	1,737	10,426	10,5
3	6,029	5,566	1,737	10,426	10,5
4	6,029	5,566	1,737	10,426	10,5
5	6,029	5,566	1,737	10,426	10,5
6	6,029	5,566	1,737	10,426	10,5
7	6,029	5,566	1,737	10,426	10,5
8	6,029	5,566	1,737	10,426	10,5
9	6,029	5,566	1,737	10,426	10,5
10	6,028	5,566	1,737	10,426	10,5
11	6,017	5,566	1,737	10,426	10,5
12	6,000	5,566	1,737	10,426	10,5
13	5,977	5,566	1,737	10,426	10,5
14	5,957	5,566	1,737	10,426	10,5
15	5,939	5,566	1,737	10,426	10,5

Chosen thickness:

$$t = 10,5 \text{ mm}$$

#### 5.2.6. Minimum thickness

At no point the thickness of the bottom shell plating is to be less than:

$$t_{min} = \sqrt{L \cdot k} \text{ [mm]} \text{ for } L \geq 50 \text{ m,}$$

or 16,0 mm, whichever is less.

$$t_{min} = \sqrt{L \cdot k} = 8,17 \text{ mm}$$

### 5.3 Side shell plating

#### 5.3.1 Side shell plating within 0,4L amidships

#### 5.3.2. Ships of $L \geq 90$ m

The thickness of the side shell plating is not to be less than the greater of the two following values:

$$t_1 = 18,3 \cdot n_1 \cdot s \cdot \sqrt{\frac{p_s}{\sigma_a}} + t_k, \text{ [mm]},$$

$$t_2 = 1,21 \cdot s \cdot \sqrt{p_s \cdot k} + t_k, \text{ [mm]},$$

where:

$$\sigma_a = \sqrt{\sigma_{dop}^2 - 3 \cdot \tau_L^2 - 0,89 \cdot \sigma_{LS}}, \text{ [N/mm}^2\text{]};$$

$$\sigma_{LS} = 0,76 \cdot \sigma_L$$

$$\sigma_L = \frac{120}{k} [\text{N/mm}^2] \text{ for } L \geq 90 \text{ m};$$

$$\tau_L = \frac{55}{k} [\text{N/mm}^2].$$

Side shell plating (Plate 16-19):

$$t_1 = 18,3 \cdot n_1 \cdot s \cdot \sqrt{\frac{p_s}{\sigma_a}} + t_k = 5,42 \text{ mm}$$

$$t_2 = 1,21 \cdot s \cdot \sqrt{p_s \cdot k} + t_k = 5,11 \text{ mm}$$

$$t_k = 1,5 \text{ mm}$$

Chosen thickness:

$$t = 8 \text{ mm}$$

### 5.3.4 Sheerstrake

The width of the sheerstrake is not to be less than:

$$b = 800 + 5 \cdot L, [\text{mm}],$$

and not be greater than:

$$b_{max} = 1800 \text{ mm.}$$

$$b = 800 + 5 \cdot L = 1263,18 \text{ mm}$$

## 5.6 Bulwark

5.6.1 The thickness of bulwark plating is not to be less than:

$$t = \left[ 0,75 - \frac{L}{1000} \right] \cdot \sqrt{L}, [\text{mm}], \text{ for } L \leq 100 \text{ m.}$$

$$t = \left[ 0,75 - \frac{L}{1000} \right] \cdot \sqrt{L} = 6,33 \text{ mm}$$

## 6 Decks

### 6.1 Strength deck

The strength deck is:

- the uppermost continuous deck which is forming the upper flange of the hull structure,
- a superstructure deck which extends into  $0,4L$  amidships and the length of which exceeds  $0,15L$ ,
- a quarter deck or the deck of a sunk superstructure which extends into  $0,4L$  amidships.

Strength deck = Passenger deck

$$k = 0,72$$

$$p_D = 11,56 \text{ kN/m}^2$$

$$p_L = 39,12 \text{ kN/m}^2$$

$$t_k = 1,5$$

$$s = 0,6$$

#### 6.1.6 Minimum thickness

The thickness of deck plating for  $0,4L$  amidships outside line of hatchways is not to be less than the greater of the two following values:

$$t_{min} = (0,45 + 0,05 \cdot L) \cdot \sqrt{k}, [\text{mm}],$$

or

$$t_{0,1L} = 1,21 \cdot s \cdot \sqrt{p_D \cdot k} + t_k, [\text{mm}].$$

$$t_{min} = (0,45 + 0,05 \cdot L) \cdot \sqrt{k} = 7,75 \text{ mm}$$

$$t_{0,1L} = 1,21 \cdot s \cdot \sqrt{p_D \cdot k} + t_k = 3,59 \text{ mm}$$

$$t_{min} > t_{0,1L}$$

Chosen thickness = 8,00 mm

### 6.2 Lower decks

#### 6.2.1 Thickness of decks for cargo loads

The plate thickness of decks loaded with cargo is not to be less than:

$$t = 1,1 \cdot s \cdot \sqrt{p_L \cdot k} + t_k, [\text{mm}],$$

but not less than:

$$t_{min} = (5,5 + 0,02 \cdot L) \cdot \sqrt{k}, [\text{mm}], \text{ for the second deck;}$$

$$t_{min} = 6,0 \text{ mm for other lower decks.}$$

$$t = 1,1 \cdot s \cdot \sqrt{p_L \cdot k} + t_k = 5,00 \text{ mm}$$

$$t_{min} = (5,5 + 0,02 \cdot L) \cdot \sqrt{k} = 6,24 \text{ mm}$$

$$t_{min} > t$$

Chosen thickness = 8,00 mm

### 6.2.2 Thickness of decks for wheel loading

The thickness of deck plating for wheel loading is to be determined by:

$$t = c \cdot \sqrt{P \cdot (1 + a_v) \cdot k} + t_k, [\text{mm}],$$

where:

$P$  = load [kN] of one wheel or group of wheels on a plate panel  $u \cdot v$ ;

$$P = \frac{Q}{n} [\text{kN}];$$

$Q$  = axle load [kN];

$n$  = number of wheels (or groups of wheels) per axle;

$a_v$  = according to 3.3.1.1;

$a_v = 0$  for harbour conditions;

$c$  = factor according to:

$\frac{u}{v} = 1$	$c = \begin{cases} 1,87 - \sqrt{\frac{a}{A} \cdot [3,4 - 4,4 \frac{a}{A}]}, \text{ for } 0 < \frac{a}{A} < 0,3, \\ 1,20 - 0,40 \frac{a}{A}, \text{ for } 0,3 \leq \frac{a}{A} \leq 1,0 \end{cases}$
$\frac{u}{v} \geq 2,5$	$c = \begin{cases} 2,00 - \sqrt{\frac{a}{A} \cdot [5,2 - 7,2 \frac{a}{A}]}, \text{ for } 0 < \frac{a}{A} < 0,3, \\ 1,20 - 0,517 \frac{a}{A}, \text{ for } 0,3 \leq \frac{a}{A} \leq 1,0 \end{cases}$

where:

$a$  = print area of wheel or group of wheels;

$A$  = area of plate panel  $u \cdot v$  (not taken greater than  $2,5 \cdot v^2$ )

$v$  = width of smaller side of plate panel;

$u$  = width of larger side of plate panel.

$$u = 3$$

$$v = 0,6$$

$$A = 1,8$$

$$a = 4,075$$

$$\frac{a}{A} = 2,26$$

Tank top:

$$u = 37,08$$

$$v = 12,00$$

$$A_{lower} = u \cdot v = 444,96$$

$$\frac{a}{A} = 0,011$$

$$\frac{u}{v} = 3,09$$

$$2,5 \cdot v^2 = 360$$

$$c = 2,00 - \sqrt{\frac{a}{A} \cdot \left[ 5,2 - 7,2 \frac{a}{A} \right]} = 1,76$$

$$P = \frac{Q}{n} = 5,75$$

$$t = c \cdot \sqrt{P \cdot (1 + a_v) \cdot k} + t_k = 7,56 \text{ mm}$$

Chosen thickness = 8,00 mm

Main deck:

$$u = 20,00$$

$$v = 12,00$$

$$A_{lower} = u \cdot v = 240,00$$

$$\frac{a}{A} = 0,017$$

$$\frac{u}{v} = 1,67$$

$$2,5 \cdot v^2 = 360$$

$$c_1 = 1,87 - \sqrt{\frac{a}{A} \cdot \left[ 3,4 - 4,4 \frac{a}{A} \right]} = 1,63$$

$$c_2 = 2,00 - \sqrt{\frac{a}{A} \cdot \left[ 5,2 - 7,2 \frac{a}{A} \right]} = 1,71$$

$$c = c_1 + \frac{(c_2 - c_1) \cdot \left( \frac{u}{v} - 1 \right)}{1,5} = 1,67$$

$$P = \frac{Q}{n} = 5,75$$

$$t = c \cdot \sqrt{P \cdot (1 + a_v) \cdot k} + t_k = 8,44 \text{ mm}$$



Chosen thickness = 9,00 mm

### 6.2.3 Machinery decks and accommodation decks

The thickness of the plates is not to be less than:

$$t = 1,1 \cdot s \cdot \sqrt{p \cdot k} + t_k, [\text{mm}],$$

$$t_{min} = 5,00 \text{ mm.}$$

$$t = 1,1 \cdot s \cdot \sqrt{p \cdot k} + t_k = 5,63 \text{ mm}$$

$$t_{min} = 5,00 \text{ mm}$$

$$t > t_{min}$$

Chosen thickness = 6,00 mm

## 7 Bottom structures

### 7.2 Double bottom

#### 7.2.2 Centre girder

Depth and thickness of the centre girder are determined as follows:

a) The depth of the centre girder is not to be less than:

$$h_{db} = 350 + 45 \cdot B, [\text{mm}],$$

$$h_{min} = 600,0 \text{ mm:}$$

where longitudinal wing bulkheads are fitted, the distance between bulkheads may be taken instead of  $B$ , not less than  $0,8 \cdot B$ .

b) The thickness of the centre girder is not to be less than:

- within  $0,7L$  amidships:

$$t = \frac{h_{db}}{h_a} \cdot \left[ \frac{h_{db}}{100} + 1,0 \right] \cdot \sqrt{k}, [\text{mm}], \text{ for } h_{db} \leq 1200 \text{ mm;}$$

$$t = \frac{h_{db}}{h_a} \cdot \left[ \frac{h_{db}}{120} + 3,0 \right] \cdot \sqrt{k}, [\text{mm}], \text{ for } h_{db} > 1200 \text{ mm;}$$

where:

$h_a$  = depth of centre girder as built [mm] where  $h_a > h_{db}$ ;

$$\frac{h_{db}}{h_a} \leq 1,0;$$

-  $0,15L$  at the ends:

$$t_1 = 0,9 \cdot t, [\text{mm}];$$

where:

$t$  = thickness within  $0,7L$  amidships [mm].

$$h_{db} = 350 + 45 \cdot 0,8B = 1070 \text{ mm}$$

$$h_{min} = 600 \text{ mm}$$

$$h_a = 1100 \text{ mm}$$

$$t = \frac{h_{db}}{h_a} \cdot \left[ \frac{h_{db}}{100} + 1,0 \right] \cdot \sqrt{k} = 9,66 \text{ mm}$$

Chosen size = 1050 × 12 mm

### 7.2.3 Side girders

The thickness of the side girders is not to be less than:

$$t = \frac{h_{db}^2}{120 \cdot h_a} \cdot \sqrt{k}, [\text{mm}].$$

$$t = \frac{h_{db}^2}{120 \cdot h_a} \cdot \sqrt{k} = 7,36 \text{ mm}$$

Chosen size = 950 × 10,5 mm

### 7.2.4 Inner bottom

The thickness of the inner bottom plating is not to be less than:

$$t = 1,1 \cdot s \cdot \sqrt{p \cdot k} + t_k, [\text{mm}],$$

where:

$p$  = design pressure [kN/m<sup>2</sup>] which is greater than the following values:

$$p_1 = 10 \cdot (d - h_{db});$$

$$p_2 = 10 \cdot h \text{ where the inner bottom forms a tank boundary};$$

$$p_3 = p_{DB} \text{ according to 3.3.2.1};$$

$$h = \text{distance from top of overflow pipe to inner bottom [m]};$$

$$h_{db} = \text{double bottom height [m]}.$$

$$p_1 = 10 \cdot (d - h_{db}) = 14,30 \text{ kN/m}^2$$

$$p_2 = 10 \cdot h = 27,50 \text{ kN/m}^2$$

$$p_3 = 5,11 \text{ kN/m}^2$$

$$t = 1,1 \cdot s \cdot \sqrt{p \cdot k} + t_k = 7,44 \text{ mm}$$

Chosen size = 8,0 mm

## 7.2.6 Double bottom, transverse framing system

7.2.6.2.1 The thickness of plate floors is not to be less than:

$$t_p = t - 2,0 \cdot \sqrt{k}, [\text{mm}];$$

$$t_{max} = 16,0 \text{ mm};$$

where:

$t$  = thickness of centre girder according to 7.2.2.2.

$$t_p = t - 2,0 \cdot \sqrt{k} = 7,96 \text{ mm}$$

Chosen size = 8,0 mm

7.2.6.2.2 The sectional area of the plate floors is not to be less than:

$$A_w = f_1 \cdot d \cdot l \cdot s \cdot \left(1 - 2 \frac{b_1}{l}\right) \cdot k, [\text{cm}^2];$$

where:

$s$  = spacing of plate floors [m];

$l$  = span between longitudinal bulkheads [m], if any;

$l = B$ , if longitudinal bulkheads are not fitted;

$b_1$  = distance between supporting point of the plate floor (ship's side, longitudinal bulkhead) and the section considered [m]; not to be taken greater than  $0,4 \cdot l$ ;

$f_1 = 0,5$  for spaces which may be empty at full draught;

$f_1 = 0,3$  elsewhere;

$k$  = material factor.

$$A_{wmin} = f_1 \cdot d \cdot l \cdot s \cdot \left(1 - 2 \frac{b_1}{l}\right) \cdot k = 0,19 \text{ cm}^2$$

## 7.2.6.3 Bracket floors

The section modulus of bottom and inner bottom frames is not to be less than:

$$W = e \cdot f_2 \cdot s \cdot l^2 \cdot p \cdot k, [\text{cm}^2];$$

where:

$p$  = design load [ $\text{kN/m}^2$ ] as follows:

for bottom frames:  $p = p_B$ ;

for inner bottom frames (the greater value is to be used):

$$p = p_{DB};$$

$$p = p_1 \text{ or } p_2;$$

$$p = 10 \cdot (d - h_{db});$$

$h_{db}$  = double bottom height [m];

$$e = 0,44 \text{ if } p = p_2;$$

$$e = 0,55 \text{ if } p = p_1 \text{ or } p_{DB};$$

$$e = 0,70 \text{ if } p = p_B;$$

$$f_2 = 0,60 \text{ where struts are provided at } \frac{l}{2};$$

$$f_2 = 1,0 \text{ elsewhere;}$$

$l$  = unsupported span [m] disregarding struts, if any.

$$p_B = 39,84 \text{ kN/m}^2$$

$$p_{DB} = 39,12 \text{ kN/m}^2$$

$$p = 14,30 \text{ kN/m}^2$$

$$e = 0,7$$

$$f_2 = 1,0$$

$$l = 3,0$$

$$W_{min} = e \cdot f_2 \cdot s \cdot l^2 \cdot p \cdot k = 108,43 \text{ cm}^2$$

#### 7.2.6.5 Struts

The cross sectional area of the struts is to be determined according to 9.3.2. The design force is to be taken as the following value:

$$P = 0,5 \cdot p \cdot s \cdot l, [\text{kN}].$$

$$P = 0,5 \cdot p \cdot s \cdot l = 35,86 \text{ kN}$$

#### 7.2.8 Design loads, permissible stresses for direct calculations

##### 7.2.8.2 Permissible stresses

##### 7.2.8.2.1 Equivalent permissible stress, $\sigma_{ekv}$

The equivalent stress is not to exceed the following value:

$$\sigma_{ekv} = \frac{230}{k}, [\text{N/mm}^2],$$

$$\sigma_{ekv} = \sqrt{\sigma_x^2 + \sigma_y^2 - \sigma_x \cdot \sigma_y + 3 \cdot \tau^2}, [\text{N/mm}^2],$$

where:

$\sigma_x$  = stress in the ship's longitudinal direction [ $\text{N/mm}^2$ ];

$$\sigma_x = \sigma_L + \sigma_l, [\text{N/mm}^2];$$

$\sigma_L$  = design hull girder bending stress  $[\text{N/mm}^2]$ ;

$\sigma_l$  = bending stress  $[\text{N/mm}^2]$  due to the load  $p$  in longitudinal direction, in longitudinal girders;

$\sigma_x = 0$  for webs of transverse girders;

$\sigma_y$  = stress in the ship's transverse direction  $[\text{N/mm}^2]$ ;

$$\sigma_y = \sigma_t, [\text{N/mm}^2];$$

$\sigma_t$  = bending stress  $[\text{N/mm}^2]$  due to load  $p$  in transverse direction, in transverse girders;

$\sigma_y = 0$  for webs of longitudinal girders;

$\tau$  = shear stress in the longitudinal girders or transverse girders due to load  $p$   $[\text{N/mm}^2]$ .

$$\sigma_x = \sigma_L + \sigma_l = 282,18 \text{ N/mm}^2$$

$$\sigma_y = \sigma_t = 35,67 \text{ N/mm}^2$$

$$\tau = 68,29 \text{ N/mm}^2$$

$$\sigma_{ekv} = \sqrt{\sigma_x^2 + \sigma_y^2 - \sigma_x \cdot \sigma_y + 3 \cdot \tau^2} = 291,24 \text{ N/mm}^2$$

$$\sigma_{ekv} = \frac{230}{k} = 319,44 \text{ N/mm}^2$$

## 8 Framing system

### 8.1 Transverse framing

#### 8.1.1.2 Definitions

$S$  = spacing of web frames [m];

$s$  = spacing of frames [m];

$l$  = unsupported span [m];

$$l_{min} = 2,0 \text{ m};$$

$l_{k1}, l_{k2}$  = length of lower/upper bracket connection at main frames within the length  $l$  [m];

$p_s$  = load on ship's sides  $[\text{kN/m}^2]$ ;

$p_e$  = load on bow structures  $[\text{kN/m}^2]$ ;

$p_L$  = 'tween deck load  $[\text{kN/m}^2]$ ;

$p_l$  = pressure  $[\text{kN/m}^2]$ ;

$f$  = factor for curved frames;

$$f = 1,0 - 2 \cdot \frac{e}{l};$$

$$f_{min} = 0,75;$$

$e$  = max. height of curve [m].

$$S = 3,0 \text{ m}$$

$$s = 0,6 \text{ m}$$

$$l_{min} = 2,0 \text{ m}$$

$$l_{k1} = 0,35 \text{ m}$$

$$l_{k2} = 0,35 \text{ m}$$

$$p_s = 38,62 \text{ kN/m}^2$$

$$p_e = 48,38 \text{ kN/m}^2$$

$$p_L = 39,12 \text{ kN/m}^2$$

$$p_I = 30,22 \text{ kN/m}^2$$

### 8.1.2 Main frames

The section modulus of the main frames including end attachments is not to be less than:

$$W = n \cdot c \cdot s \cdot l^2 \cdot p_s \cdot f \cdot k, [\text{cm}^3],$$

where:

$$n = 0,9 - 0,0035 \cdot L, \text{ for } L > 100 \text{ m};$$

$$n = 0,55;$$

$$c = 1,0 - (l_{k1} + 0,45 \cdot l_{k2});$$

$$c_{min} = 0,65.$$

$$n = 0,9 - 0,0035 \cdot L = 0,58$$

$$c = 1,0 - (l_{k1} + 0,45 \cdot l_{k2}) = 0,65$$

$$l = 2,15 \text{ m}$$

$$W_{min} = n \cdot c \cdot s \cdot l^2 \cdot p_s \cdot f \cdot k = 21,65 \text{ cm}^3$$

Chosen size = T550 × 10, 150 × 10

### 8.1.2.2 Frames in tanks

The section modulus of frames in tanks or in hold spaces for ballast water is not to be less than the greater of the following values:

$$W_1 = n \cdot c \cdot s \cdot l^2 \cdot p_1 \cdot f \cdot k, [\text{cm}^3],$$

or

$$W_2 = 0,44 \cdot s \cdot l^2 \cdot p_2 \cdot k, [\text{cm}^3].$$

$$W_1 = n \cdot c \cdot s \cdot l^2 \cdot p_1 \cdot f \cdot k = 16,94 \text{ cm}^3$$

$$W_2 = 0,44 \cdot s \cdot l^2 \cdot p_1 \cdot k = 26,55 \text{ cm}^3$$

Chosen size: T400 × 10, 150 × 15

### 8.1.3 Tween deck and superstructure frames

The section modulus of the 'tween deck and superstructure frames are not to be less than:

$$W = 0,55 \cdot s \cdot l^2 \cdot p \cdot f \cdot k, [\text{cm}^3],$$

where:

$$p_{min} = 0,4 \cdot p_L \cdot \left(\frac{b}{l}\right)^2, [\text{kN/m}^2];$$

$b$  = unsupported span of the deck beam below the respective 'tween deck frame [m].

Main deck – Passenger deck:

$$l = 4,8 \text{ m}$$

$$p = 4,25 \text{ kN/m}^2$$

$$W = 0,55 \cdot s \cdot l^2 \cdot p \cdot f \cdot k = 17,43 \text{ cm}^3$$

Chosen size = T400 × 10, 250 × 15

Passenger deck – Sun deck:

$$l = 2,4 \text{ m}$$

$$p = 15,65 \text{ kN/m}^2$$

$$W = 0,55 \cdot s \cdot l^2 \cdot p \cdot f \cdot k = 16,06 \text{ cm}^3$$

Chosen size = T150 × 7, 100 × 10

## 8.2 Bottom, side-and deck longitudinals, side transverses

### 8.2.2 Definitions

$p$  = load [kN/m<sup>2</sup>];

$p$  =  $p_B$  for bottom longitudinals;

$p$  =  $p_s$  for side longitudinals;

$p$  =  $p_l$  for longitudinals at deck and at ship's sides, at longitudinal bulkheads and inner bottom in way of tanks;

$p$  = not to be taken less than  $p_1 - [10 \cdot d_{min} - p_o \cdot C_F]$  for bottom longitudinals in way of tanks;

$p$  = not to be taken larger than  $p_1 - \left[10 \cdot (d_{min} - z) - p_o \cdot C_F \cdot \left(1 + \frac{z}{d_{min}}\right)\right]$  for side

longitudinals below  $d_{min}$ ;

$p = p_d$  for side and deck longitudinals as well as for horizontal stiffeners of longitudinal bulkheads in tanks which may be partially filled;

$p = p_{DB}$  for inner bottom longitudinals, however, not less than the load corresponding to the distance between inner bottom and deepest load waterline;

$p = p_L$  for longitudinals of cargo decks and for inner bottom longitudinals;

$\sigma_D =$  maximum normal stress  $\sigma_L$  due to longitudinal hull girder bending [N/mm<sup>2</sup>] in the strength deck level at side;

$\sigma_B =$  maximum normal stress  $\sigma_L$  due to longitudinal hull girder bending [N/mm<sup>2</sup>] in the bottom;

$\sigma_D = \sigma_{Lmax}$ ;

$\sigma_B = 0,8 \cdot \sigma_{Lmax}$ ;

$z =$  distance [m] above base line;

$m = m_1^2 - m_2^2$ ;

$m_l = 1 - \sum \left[ \frac{l_k}{l} (\sin \alpha_k)^2 \right]$

$l_k =$  according to Figure 8.2.2 [m];

$\alpha_k =$  according to Figure 8.2.2 [°];

$m_2 = 0,204 \frac{s}{l} \left[ 4 - \left( \frac{s}{l} \right)^2 \right]$ .

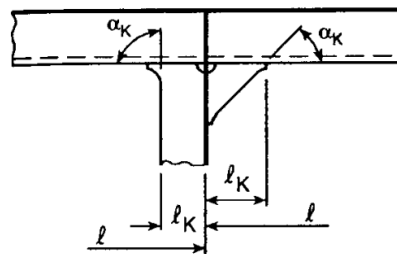

Figure 8.2.2

### 8.2.3 Scantling

The section modulus and shear area of longitudinals and longitudinal beams of the strength deck is not to be less than:

$$W_l = \frac{83,3}{\sigma_{dop}} \cdot m \cdot s \cdot l^2 \cdot p, [\text{cm}^3],$$

$$A_l = (1 - 0,817 \cdot m_2) \cdot 0,05 \cdot s \cdot l \cdot p \cdot k, [\text{cm}^2].$$

The permissible stress  $\sigma_{dop}$  is to be determined according to:

- below the neutral axis of the respective cross section:



$$\sigma_{dop} = \sigma_t - \sigma_B + z \cdot \frac{\sigma_B + \sigma_D}{D}, [\text{N/mm}^2];$$

- above the neutral axis of the respective cross section:

$$\sigma_{dop} = \sigma_t + \sigma_B - z \cdot \frac{\sigma_B + \sigma_D}{D}, [\text{N/mm}^2];$$

$$\sigma_{dop} \leq \frac{150}{k}, [\text{N/mm}^2];$$

$$\sigma_t = \left(0,8 + \frac{L}{450}\right) \cdot \frac{230}{k}, [\text{N/mm}^2];$$

$$\sigma_{tmax} = \frac{230}{k}, [\text{N/mm}^2].$$

$$p_b = 36,13 \text{ kN/m}^2$$

$$p_s = 38,62 \text{ kN/m}^2$$

$$p_l = 31,74 \text{ kN/m}^2$$

$$\sigma_{tmax} = \frac{230}{k} = 319,44 \text{ N/mm}^2$$

$$\sigma_{dop} \leq \frac{150}{k} \dots \sigma_{dop} \leq 208,33 \text{ N/mm}^2$$

$$\sigma_B = 0,8 \cdot \sigma_{Lmax} = 228,45 \text{ N/mm}^2$$

$$\sigma_B = \sigma_{Lmax} = 285,56 \text{ N/mm}^2$$

$$z_{neutral} = 2,563 \text{ m}$$

$$m_1 = 1 - \sum \left[ \frac{l_k}{l} (\sin \alpha_k)^2 \right] = 0,75$$

$$m_2 = 0,204 \frac{s}{l} \left[ 4 - \left( \frac{s}{l} \right)^2 \right] = 0,16$$

$$m = m_1^2 - m_2^2 = 0,54$$

Bottom longitudinals:

$$\sigma_{dop} = \frac{150}{k} = 208,33 \text{ N/mm}^2$$

$$W_l = \frac{83,3}{\sigma_{dop}} \cdot m \cdot s \cdot l^2 \cdot p = 42,05 \text{ cm}^3$$

$$A_l = (1 - 0,817 \cdot m_2) \cdot 0,05 \cdot s \cdot l \cdot p \cdot k = 2,03 \text{ cm}^2$$

Chosen size = HP160 × 7

Bilge strake longitudinals:

$$\sigma_{dop} = \sigma_t - \sigma_B + z \cdot \frac{\sigma_B + \sigma_D}{D} = 158,63 \text{ N/mm}^2$$

$$W_l = \frac{83,3}{\sigma_{dop}} \cdot m \cdot s \cdot l^2 \cdot p = 59,53 \text{ cm}^3$$

$$A_l = (1 - 0,817 \cdot m_2) \cdot 0,05 \cdot s \cdot l \cdot p \cdot k = 3,50 \text{ cm}^2$$

Chosen size = HP140 × 7

Tank top longitudinals:

$$\sigma_{dop} = \frac{150}{k} = 208,33 \text{ N/mm}^2$$

$$W_l = \frac{83,3}{\sigma_{dop}} \cdot m \cdot s \cdot l^2 \cdot p = 36,94 \text{ cm}^3$$

$$A_l = (1 - 0,817 \cdot m_2) \cdot 0,05 \cdot s \cdot l \cdot p \cdot k = 1,79 \text{ cm}^2$$

Chosen size = HP120 × 7

Main deck longitudinals:

$$\sigma_{dop} = \frac{150}{k} = 208,33 \text{ N/mm}^2$$

$$W_l = \frac{83,3}{\sigma_{dop}} \cdot m \cdot s \cdot l^2 \cdot p = 56,31 \text{ cm}^3$$

$$A_l = (1 - 0,817 \cdot m_2) \cdot 0,05 \cdot s \cdot l \cdot p \cdot k = 2,72 \text{ cm}^2$$

Chosen size = HP200 × 9

Passenger deck longitudinals:

$$\sigma_{dop} = \sigma_t + \sigma_B - z \cdot \frac{\sigma_B + \sigma_D}{D} = 174,03 \text{ N/mm}^2$$

$$W_l = \frac{83,3}{\sigma_{dop}} \cdot m \cdot s \cdot l^2 \cdot p = 16,10 \text{ cm}^3$$

$$A_l = (1 - 0,817 \cdot m_2) \cdot 0,05 \cdot s \cdot l \cdot p \cdot k = 0,65 \text{ cm}^2$$

Chosen size = HP100 × 6

Side longitudinals (Main deck – Passenger deck):

$$\sigma_{dop} = \frac{150}{k} = 208,33 \text{ N/mm}^2$$

$$W_l = \frac{83,3}{\sigma_{dop}} \cdot m \cdot s \cdot l^2 \cdot p = 23,99 \text{ cm}^3$$

$$A_l = (1 - 0,817 \cdot m_2) \cdot 0,05 \cdot s \cdot l \cdot p \cdot k = 1,16 \text{ cm}^2$$

Chosen size = HP100 × 6

## 9 Supporting deck structures

### 9.1 General

#### 9.1.1 Definitions

$k$  = material factor;

$l$  = unsupported span [m];

$b$  = width of deck supported [m];

$p$  = deck load  $p_D$ ,  $p_{DA}$  or  $p_L$  [kN/m<sup>2</sup>];

$f$  = 0,55;

$f$  = 0,75 for beams, girders and transverses which are simply supported on one or both ends;

$P_u$  = pillar load;

$P_u = p \cdot A + P_i$  [kN];

$A$  = load area for one pilar [m<sup>2</sup>];

$P_i$  = load from pillars located above the pillar considered [kN];

$\lambda_u$  = degree of slenderness of the pillar;

$\lambda_u = \frac{l_u}{i_u}$ ;

$l_u$  = length of the pillar [cm];

$i_u$  = radius of gyration of the pillar [cm];

$i_u = \sqrt{\frac{I_u}{A_u}}$  [cm];

$I_u$  = moment of inertia of the pillar [cm<sup>4</sup>];

$A_u$  = sectional area of the pilar [cm<sup>2</sup>];

$i_u = 0,25 \cdot d_u$  for solid pillars of circular cross section;

$i_u = 0,25 \cdot \sqrt{d_{uv}^2 + d_{uu}^2}$  for tubular pillars;

$d_u$  = pillar diameter [cm];

$d_{uv}$  = outside diameter of pillar [cm];

$d_{uu}$  = inside diameter of pillar [cm];

$m_2$  = factor according to 8.2.2.

#### 9.1.2 Permissible stresses

Where the scantlings of girders not forming part of the longitudinal hull structure, or of transverses, deck beams, etc. are determined by means of strength calculations the following stresses are not to be exceeded:

$$\sigma_b = \frac{150}{k}, [\text{N/mm}^2];$$

$$\tau = \frac{100}{k}, [\text{N/mm}^2];$$

$$\sigma_{ekv} = \sqrt{\sigma^2 + 3\tau^2} = \frac{180}{k}, [\text{N/mm}^2].$$

$$\sigma_b = \frac{150}{k} = 208,33 \text{ N/mm}^2$$

$$\tau = \frac{100}{k} = 138,89 \text{ N/mm}^2$$

$$\sigma_{ekv} = \sqrt{\sigma^2 + 3\tau^2} = 318,23 \text{ N/mm}^2$$

## 9.2 Deck beams, longitudinals and girders

### 9.2.1 Transverse deck beams and deck longitudinals

The section modulus and shear area of transverse deck beams and of deck longitudinals not contributing to the longitudinal strength are to be determined by the following formula:

$$W_d = f \cdot s \cdot p \cdot l^2 \cdot k, [\text{cm}^3];$$

$$A_d = (1 - 0,817 \cdot m_2) \cdot 0,05 \cdot s \cdot p \cdot l \cdot k, [\text{cm}^2].$$

Passenger deck – Sun deck stiffeners:

$$W_d = f \cdot s \cdot p \cdot l^2 \cdot k = 19,24 \text{ cm}^3$$

$$A_d = (1 - 0,817 \cdot m_2) \cdot 0,05 \cdot s \cdot p \cdot l \cdot k = 0,54 \text{ cm}^2$$

Chosen size = HP100 × 6

### 9.2.4 Girders and transverses

The section modulus and the shear area are not to be taken less than following values:

$$W = f \cdot b \cdot p \cdot l^2 \cdot k, [\text{cm}^3];$$

$$A_w = 0,05 \cdot b \cdot p \cdot l \cdot k, [\text{cm}^2].$$

Passenger deck – Sun deck beams:

$$W = f \cdot b \cdot p \cdot l^2 \cdot k = 160,13 \text{ cm}^3$$

$$A_w = 0,05 \cdot b \cdot p \cdot l \cdot k = 4,54 \text{ cm}^2$$

Chosen size = T150 × 7, 100 × 10

## 9.3 Pillars

9.3.1.3 The wall thickness of tubular pillars which may be expected to be damaged during loading and unloading operations is not to be less than:

$$t_u = 4,5 + 0,015 \cdot d_{uv} \text{ [mm] for } d_{uv} \leq 300 \text{ mm;}$$

$$t_u = 0,03 \cdot d_{uv} \text{ [mm] for } d_{uv} > 300 \text{ mm;}$$

where:

$$d_{uv} = \text{outside diameter of tubular pillar [mm].}$$

$$d_{uv} = 114,3 \text{ mm}$$

$$t_u = 4,5 + 0,015 \cdot d_{uv} = 7,1 \text{ mm}$$

### 9.3.2 Scantlings

The sectional area of pillar is not to be less than:

$$A_u = 10 \cdot \frac{P_u}{\sigma_t}, \text{ [cm}^2\text{]},$$

where:

$$\sigma_t = \text{permissible compressive stress according to Table 9.3.2. [N/mm}^2\text{].}$$

**Table 9.3.2**

Degree of slenderness ( $\lambda_u$ )	Permissible compressive stress [N/mm <sup>2</sup> ]	
	Pillars within accommodation	Elsewhere
$\leq 100$	$140 - 0,0067 \cdot \lambda_u^2$	$117 - 0,0056 \cdot \lambda_u^2$
$> 100$	$7,3 \cdot \frac{10^5}{\lambda_u^2}$	$6,1 \cdot \frac{10^5}{\lambda_u^2}$

$$\lambda_u = \frac{l_u}{i_u} = 20,56$$

$$\sigma_t = 140 - 0,0067 \cdot \lambda_u^2 = 137,17 \text{ N/mm}^2$$

$$P_v = \left(\frac{d_{uv}}{2}\right)^2 \cdot \pi = 10\,260,83 \text{ cm}^2$$

$$P_u = \left(\frac{d_{uv}}{2} - \sigma_t\right)^2 \cdot \pi = 7\,869,70 \text{ cm}^2$$

$$P = \frac{P_v - P_u}{100} = 23,91 \text{ cm}^2$$

$$A_{u,min} = 10 \cdot \frac{P}{\sigma_t} = 17,28 \text{ cm}^2$$

Chosen size =  $\Phi 114,3 \times 7,1$

## 10 Watertight bulkheads

## 10.1 General

### 10.1.1 Watertight subdivision

#### 10.1.1.3 Arrangement of machinery space

For ships without longitudinal bulkheads in the cargo hold and the number of watertight transverse bulkheads should, in general, not be less than given in Table 10.1.1.3.

Table 10.1.1.3

L [m]	Arrangement of machinery space	
	aft	elsewhere
$L \leq 65$	3	4
$65 < L \leq 85$	4	4
$85 < L \leq 105$	4	5
$105 < L \leq 125$	5	6
$125 < L \leq 145$	6	7
$145 < L \leq 165$	7	8
$165 < L \leq 185$	8	9
$L > 185$	to be specially considered	

## 10.2 Scantlings

### 10.2.1.3 Definitions

$t_k$  = corrosion addition;

$s$  = spacing of stiffeners [m];

$l$  = unsupported span [m];

$p = 9,81 \cdot h$  [kN/m<sup>2</sup>];

$h$  = distance from the load centre of the structure to a point 1 m above the bulkhead deck, at the ship's side, for the collision bulkhead to a point 1 m above the collision bulkhead at the ship's side;

$C_p, C_s$  = coefficients according to Table 10.2.1.3;

$k = \frac{235}{R_{eH}}$ ;

$R_{eH}$  = minimum nominal upper yield point [N/mm<sup>2</sup>].

Table 10.2.1.3

Coefficient $C_p$ and $C_s$		Collision bulkhead	Other bulkheads
Plating	$C_p$	$1,1 \cdot \sqrt{k}$	$0,9 \cdot \sqrt{k}$
Stiffeners and corrugated bulkhead elements	$C_s$ : in case of constraint of both sides	$0,33 \cdot k$	$0,265 \cdot k$
	$C_s$ : in case of simple support of one end and constraint at the other end	$0,45 \cdot k$	$0,36 \cdot k$
	$C_s$ : both ends simply supported	$0,66 \cdot k$	$0,53 \cdot k$

Collision bulkhead:

$$C_p = 1,1 \cdot \sqrt{k} = 0,95$$

$$C_s = 0,66 \cdot k = 0,49$$

Other bulkheads:

$$C_p = 0,9 \cdot \sqrt{k} = 0,78$$

$$C_s = 0,53 \cdot k = 0,40$$

### 10.2.2 Bulkhead plating

The thickness of the bulkhead plating is not to be less than:

$$t = C_p \cdot s \cdot \sqrt{p} + t_k, [\text{mm}],$$

but not less than:

$$t_{min} = 6,0 \cdot \sqrt{k}, [\text{mm}].$$

$$t_{collision} = C_p \cdot s \cdot \sqrt{p} + t_k = 4,39 \text{ mm}$$

$$t_{other} = C_p \cdot s \cdot \sqrt{p} + t_k = 3,91 \text{ mm}$$

$$t_{min} = 6,0 \cdot \sqrt{k} = 5,19 \text{ mm}$$

$$t_{min} > t_{collision} > t_{other}$$

Chosen thickness = 8,0 mm

### 10.2.3 Stiffeners

The section modulus of bulkhead stiffeners is not to be less than:

$$W = C_s \cdot s \cdot l^2 \cdot p, [\text{cm}^3].$$

$$W = C_s \cdot s \cdot l^2 \cdot p = 58,35 \text{ cm}^3$$

Chosen size = 140 × 8,5

## 11 Tank structures

### 11.1.7 Minimum thickness

The thickness of all structures in tanks is not to be less than the following minimum value:

$$t_{min} = 5,5 + 0,02 \cdot L, [\text{mm}].$$

$$t_{min} = 5,5 + 0,02 \cdot L = 7,35 \text{ mm}$$

## 11.2 Scantlings

### 11.2.1 Definitions

$k$  = material factor;

$s$  = spacing of stiffeners or load width [m];

$l$  = unsupported span [m];

$p$  = load  $p1$  or  $pd$  [kN/m<sup>2</sup>];

$p_2$  = load [kN/m<sup>2</sup>];

$t_k$  = corrosion addition [mm];

$h$  = filling height of tank [m];

$l_t$  = tank length [m];

$b_t$  = tank breadth [m];

$$\sigma_a = \sqrt{\left(\frac{235}{k}\right)^2 - 3 \cdot \tau_L^2 - 0,89 \cdot \sigma_L} [\text{N/mm}^2];$$

$\sigma_L, \tau_L$  = design hull girder bending or shear stress [N/mm<sup>2</sup>];

$C = 1,0$  for transverse stiffening;

$C = 0,83$  for longitudinal stiffening.

### 11.2.2 Plating

The plate thickness is not to be less than:

$$t_1 = 1,1 \cdot s \cdot \sqrt{p \cdot k} + t_k, [\text{mm}],$$

$$t_2 = 0,9 \cdot s \cdot \sqrt{p_2 \cdot k} + t_k, [\text{mm}].$$

The thickness of tank boundaries (including deck and inner bottom) carrying also normal and shear stresses due to longitudinal hull girder bending is not to be less than:

$$t = 16,8 \cdot C \cdot s \cdot \sqrt{\frac{p}{\sigma_a}} + t_k, [\text{mm}].$$

Fresh water tank in double bottom:

$$t_1 = 1,1 \cdot s \cdot \sqrt{p \cdot k} + t_k = 5,35 \text{ mm}$$



$$t_2 = 0,9 \cdot s \cdot \sqrt{p_2 \cdot k} + t_k = 6,08 \text{ mm}$$

$$\sigma_a = \sqrt{\left(\frac{235}{k}\right)^2 - 3 \cdot \tau_L^2} - 0,89 \cdot \sigma_L = 185,77 \text{ N/mm}^2$$

$$t = 16,8 \cdot C \cdot s \cdot \sqrt{\frac{p}{\sigma_a}} + t_k = 6,96 \text{ mm}$$

Chosen thickness = 7,00 mm

Roll reduction below wheelhouse deck:

$$t_1 = 1,1 \cdot s \cdot \sqrt{p \cdot k} + t_k = 4,58 \text{ mm}$$

$$t_2 = 0,9 \cdot s \cdot \sqrt{p_2 \cdot k} + t_k = 4,20 \text{ mm}$$

$$\sigma_a = \sqrt{\left(\frac{235}{k}\right)^2 - 3 \cdot \tau_L^2} - 0,89 \cdot \sigma_L = 185,77 \text{ N/mm}^2$$

$$t = 16,8 \cdot C \cdot s \cdot \sqrt{\frac{p}{\sigma_a}} + t_k = 4,99 \text{ mm}$$

Chosen thickness = 6,00 mm

### 11.2.3 Stiffeners and girders

The section modulus of stiffeners and girders constrained at their ends, which are not considered longitudinal strength members, is not to be less than:

$$W_1 = 0,55 \cdot s \cdot l^2 \cdot p \cdot k, [\text{cm}^3],$$

$$W_2 = 0,44 \cdot s \cdot l^2 \cdot p_2 \cdot k, [\text{cm}^3].$$

Where one or both ends are simply supported, the section moduli are to be increased by 50%.

The cross sectional area of the girder webs is not to be less than:

$$A_{w1} = 0,05 \cdot s \cdot l \cdot p \cdot k, [\text{cm}^2],$$

$$A_{w2} = 0,04 \cdot s \cdot l \cdot p_2 \cdot k, [\text{cm}^2].$$

$A_{w2}$  is to be increased by 50% at the position of constraint for a length of  $0,1L$ .

Fresh water tank in double bottom:

$$W_1 = 0,55 \cdot s \cdot l^2 \cdot p \cdot k = 67,87 \text{ cm}^3$$

$$W_2 = 0,44 \cdot s \cdot l^2 \cdot p_2 \cdot k = 59,58 \text{ cm}^3$$

$$A_{w1} = 0,05 \cdot s \cdot l \cdot p \cdot k = 2,06 \text{ cm}^2$$

$$A_{w2} = 0,04 \cdot s \cdot l \cdot p_2 \cdot k = 1,81 \text{ cm}^2$$

Chosen size = HP120 × 7

Roll reduction below wheelhouse deck:

$$W_1 = 0,55 \cdot s \cdot l^2 \cdot p \cdot k = 39,89 \text{ cm}^3$$

$$W_2 = 0,44 \cdot s \cdot l^2 \cdot p_2 \cdot k = 36,78 \text{ cm}^3$$

$$A_{w1} = 0,05 \cdot s \cdot l \cdot p \cdot k = 1,81 \text{ cm}^2$$

$$A_{w2} = 0,04 \cdot s \cdot l \cdot p_2 \cdot k = 1,67 \text{ cm}^2$$

Chosen size = HP100 × 6

## 13 Superstructures and deckhouses

### 13.1 General

A long deckhouse is a deckhouse the length of which within  $0,4L$  amidships exceeds  $0,2L$  or 12 m. The strength of a long deckhouse is to be especially considered.

Superstructures extending into the range of  $0,4L$  amidships and the length of which exceeds  $0,15L$  are defined as effective superstructures. Their side plating is to be treated as a shell plating and their deck as a strength deck.

All superstructures being located beyond  $0,4L$  amidships or having a length of less than  $0,15L$  or less than 12 m are considered as non-effective superstructures.

### 13.2 Side plating and decks of non-effective superstructures

#### 13.2.1 Side plating

The thickness of the side plating is not to be less than the greater of the following values:

$$t = 1,21 \cdot s \cdot \sqrt{p \cdot k} + t_k, \text{ [mm]},$$

$$t = 0,8 \cdot t_{min}, \text{ [mm]},$$

where:

$p = p_s$  or  $p_e$  as the case may be,

$t_{min}$  = according to 5.2.6.

$$t = 1,21 \cdot s \cdot \sqrt{p \cdot k} + t_k = 3,60 \text{ mm}$$

$$t = 0,8 \cdot t_{min} = 6,53 \text{ mm}$$

Chosen thickness = 6,00 mm

(5.3.3 Above a level  $d + \frac{C_W}{2}$  above base line smaller thicknesses than  $t_{min}$  may be accepted if the stress level permits such reduction.)

### 13.2.2 Deck plating

The thickness of deck plating is not to be less than the greater of the following values:

$$t = 1,21 \cdot s \cdot \sqrt{p \cdot k} + t_k, \text{ [mm]},$$

$$t = (5,5 + 0,02 \cdot L) \cdot \sqrt{k}, \text{ [mm]},$$

where:

$p = p_{DA}$  or  $p_L$  (the greater values is to be taken);

$L =$  need not be taken greater than 200 m.

$$t = 1,21 \cdot s \cdot \sqrt{p \cdot k} + t_k = 5,54 \text{ mm}$$

$$t = (5,5 + 0,02 \cdot L) \cdot \sqrt{k} = 5,85 \text{ mm}$$

Chosen thickness = 6,00 mm

### 13.3 Superstructure end bulkheads and deckhouse walls

The design load for determining scantlings is:

$$p_A = n \cdot c \cdot (b \cdot f - z), \text{ [kN/m}^2\text{]}$$

where:

$n = 20 + \frac{L}{12}$  for the lowest tier of unprotected fronts (normally situated above the uppermost continuous deck to which the rule depth  $D$  is to be measured);

$n = 10 + \frac{L}{12}$  for 2<sup>nd</sup> tier unprotected fronts;

$n = 5 + \frac{L}{15}$  for 3<sup>rd</sup> tier of sides and protected fronts;

$n = 7 + \frac{L}{100} - 8 \cdot \frac{x}{L}$  for aft ends abaft amidship;

$n = 5 + \frac{L}{100} - 4 \cdot \frac{x}{L}$  for aft ends forward amidship;

$$b = \begin{cases} 1,0 + \left[ \frac{\frac{x}{L} - 0,45}{C_b + 0,2} \right]^2, & \text{for } \frac{x}{L} < 0,45, \\ 1,0 + 1,5 \cdot \left[ \frac{\frac{x}{L} - 0,45}{C_b + 0,2} \right]^2, & \text{for } \frac{x}{L} \geq 0,45; \end{cases}$$

$0,60 \leq C_b \leq 0,80$ ;

$x =$  distance [m] between the bulkhead considered and aft end of the length  $L$ ; when determining sides of a deckhouse, the deckhouse is to be subdivided into parts of approximately equal length, not exceeding  $0,15L$  each, and  $x$  is to be take as the distance between aft end of the length  $L$  and the centre of each part considered;

$$f = \begin{cases} 0,1L \cdot e^{-\frac{L}{300}} - \left[1 - \left(\frac{L}{150}\right)^2\right], & \text{for } L < 150 \text{ m,} \\ 0,1L \cdot e^{-\frac{L}{300}}, & \text{for } 150 \text{ m} \leq L \leq 300 \text{ m,} \\ 11,0, & \text{for } L > 300 \text{ m;} \end{cases}$$

$z$  = vertical distance [m] from the summer load line to the midpoint of stiffener span or to the middle of the plate field;

$$c = 0,3 + 0,7 \frac{b'}{B};$$

$c$  = not to be taken less than 1,0 for exposed machinery parts;

$b'$  = breadth of deckhouse at the position considered [m];

$B$  = actual maximum breadth of ship on the exposed weather deck at the position considered [m];

$\frac{b'}{B}$  = not to be taken less than 0,25;

$p_A$  = not to be taken less than the minimum values given in Table 13.3.2.

**Table 13.3.2**

$L$ [m]	$p_{Amin}$ [kN/m <sup>2</sup> ]	
	Lowest tier of unprotected fronts	Elsewhere
$\leq 50$	30	15
$> 50$ $\leq 250$	$25 + \frac{L}{10}$	$12,5 + \frac{L}{20}$
$> 250$	50	25

$$n = 20 + \frac{L}{12} = 27,73$$

$$n = 10 + \frac{L}{12} = 17,73$$

$$n = 5 + \frac{L}{15} = 11,18$$

$$b = 1,0 + 1,5 \cdot \left[ \frac{x-0,45}{c_b+0,2} \right]^2 = 1,01$$

$$f = 0,1L \cdot e^{-\frac{L}{300}} - \left[1 - \left(\frac{L}{150}\right)^2\right] = 6,19$$

$$z = 9,75 \text{ m}$$

$$c = 0,3 + 0,7 \frac{b'}{B} = 0,77$$

$$p_{A,lowest} = n \cdot c \cdot (b \cdot f - z) = 34,27 \text{ kN/m}^2$$

$$p_A = n \cdot c \cdot (b \cdot f - z) = 17,14 \text{ kN/m}^2$$

### 13.3.3 Scantlings

#### 13.3.3.1 Stiffeners

The section modulus of the stiffeners is to be determined according to the following formula:

$$W = 0,35 \cdot s \cdot l^2 \cdot p_A \cdot k, [\text{cm}^3],$$

where:

$l$  = unsupported span [m];  $l$  is to be taken as the superstructure height or deckhouse height respectively, however, not less than 2,0 m;

$s$  = spacing of stiffeners [m].

Sun deck:

$$W = 0,35 \cdot s \cdot l^2 \cdot p_A \cdot k = 56,42 \text{ cm}^3$$

Chosen size = HP100 × 6

Superstructure:

$$W = 0,35 \cdot s \cdot l^2 \cdot p_A \cdot k = 28,21 \text{ cm}^3$$

Chosen size = HP100 × 6

#### 13.3.3.2 Plate thickness

The thickness of the plating is to be determined according to the following formula:

$$t = 0,95 \cdot s \cdot \sqrt{p_A \cdot k} + t_k, [\text{mm}],$$

but not less than:

$$t_{min} = \left(5,0 + \frac{L}{100}\right) \cdot \sqrt{k} [\text{mm}] \text{ for the lowest tier;}$$

$$t_{min} = \left(4,0 + \frac{L}{100}\right) \cdot \sqrt{k} [\text{mm}] \text{ for the upper tiers, however, not less than 5,00 mm.}$$

Sun deck:

$$t = 0,95 \cdot s \cdot \sqrt{p_A \cdot k} + t_k = 4,84 \text{ mm}$$

$$t_{min} = \left(5,0 + \frac{L}{100}\right) \cdot \sqrt{k} = 5,03 \text{ mm}$$

Chosen thickness = 6,00 mm

Superstructure:

$$t = 0,95 \cdot s \cdot \sqrt{p_A \cdot k} + t_k = 4,93 \text{ mm}$$

$$t_{min} = \left(5,0 + \frac{L}{100}\right) \cdot \sqrt{k} = 3,86 \text{ mm}$$

Chosen thickness = 6,00 mm

TABLE 5-1





SECTION MODULUS WITH ATTACHED PLATING OF 610mm  
OF STANDARD DIN SECTIONS

W cm <sup>3</sup>				
33,0	90 × 11 ( 9,90. 33,0.0,6) 110 × 8 ( 8,80. 33,4.0,5)			
34,0		60 × 60 × 8 ( 9,03. 34,4.0,6)		
35,0	75 × 15 (11,25. 35,2.0,9) 100 × 10 (10,00. 35,8.0,6)	55 × 55 × 10 (10,10. 35,3.0,8) 65 × 65 × 7 ( 8,70. 35,9.0,6)	75 × 50 × 7 ( 8,30. 35,6.0,6)	100 × 8 ( 7,74. 35,8.0,5)
36,0	90 × 12 (10,80. 36,5.0,7)	70 × 70 × 6 ( 8,13. 36,3.0,6)	65 × 50 × 9 ( 9,58. 36,9.0,7)	
37,0	82 × 14 (11,48. 37,4.0,8)			
38,0	92 × 12 (11,04. 38,0.0,7) 110 × 9 ( 9,90. 38,0.0,6)		80 × 40 × 8 ( 9,01. 38,0.0,6) 75 × 55 × 7 ( 8,66. 38,0.0,6)	
39,0	80 × 15 (12,00. 39,1.0,9) 120 × 8 ( 9,60. 39,3.0,6) 100 × 11 (11,00. 39,9.0,7)			100 × 7 ( 8,74. 39,6.0,6)
40,0	90 × 13 (11,70. 40,1.0,8) 122 × 8 ( 9,76. 40,6.0,6)	65 × 65 × 8 ( 9,85. 40,6.0,7)	80 × 65 × 6 ( 8,41. 40,7.0,6)	
41,0		70 × 70 × 7 ( 9,40. 41,9.0,7)		
42,0	80 × 16 (12,80. 42,4.1,0) 110 × 10 (11,00. 42,7.0,7)	75 × 75 × 6 ( 8,75. 42,0.0,6) 60 × 60 × 10 (11,10. 42,0.0,8)		
43,0				100 × 8 ( 9,74. 43,4.0,6)
44,0	100 × 12 (12,00. 44,0.0,8)		75 × 50 × 9 (10,50. 44,8.0,7) 90 × 60 × 6 ( 8,69. 44,8.0,6)	
45,0	92 × 14 (12,88. 45,5.0,9) 102 × 12 (12,24. 45,6.0,8) 130 × 8 (10,40. 45,7.0,7)	65 × 65 × 9 (11,00. 45,1.0,8)		
46,0			100 × 50 × 6 ( 8,73. 46,5.0,6)	
47,0	110 × 11 (12,10. 47,4.0,7) 90 × 15 (13,50. 47,7.0,9)		75 × 55 × 9 (10,90. 47,7.0,7)	
48,0	100 × 13 (13,00. 48,3.0,8)	75 × 75 × 7 (10,10. 48,2.0,7)		
50,0	120 × 10 (12,00. 50,1.0,7) 90 × 16 (14,40. 51,6.1,0) 120 × 10 (12,20. 51,7.0,8) 130 × 9 (11,70. 51,9.0,7)			120 × 6 ( 9,31. 51,2.0,7)
52,0	110 × 12 (13,20. 52,3.0,8) 140 × 8 (11,20. 52,6.0,8) 100 × 14 (14,00. 52,7.0,9)	70 × 70 × 9 (11,90. 52,6.0,8)	80 × 65 × 8 (11,00. 52,9.0,8)	
54,0	102 × 14 (14,28. 54,6.0,9) 120 × 11 (13,20. 55,6.0,8)	65 × 65 × 11 (13,20. 54,2.1,0) 75 × 75 × 8 (11,50. 54,6.0,8) 80 × 80 × 7 (10,80. 55,0.0,8)		
56,0	100 × 15 (15,00. 57,2.1,0) 110 × 13 (14,30. 57,3.0,9) 92 × 17 (15,64. 57,7.1,1)			120 × 7 (10,50. 56,4.0,8)
58,0	130 × 10 (13,00. 58,1.0,8) 90 × 18 (16,20. 59,8.1,2) 150 × 8 (12,00. 59,9.0,8)		90 × 60 × 8 (11,40. 58,3.0,8)	
60,0	120 × 12 (14,40. 61,3.0,9) 100 × 16 (16,00. 61,8.1,1)		100 × 50 × 8 (11,50. 60,5.0,8) 90 × 75 × 7 (11,10. 60,6.0,8)	120 × 8 (11,70. 61,8.0,8)
62,0	110 × 14 (15,40. 62,4.1,0) 122 × 12 (14,64. 63,2.0,9)	80 × 80 × 8 (12,30. 62,2.0,9) 70 × 70 × 11 (14,30. 62,9.1,0)	100 × 65 × 7 (11,20. 63,6.0,8)	
64,0	130 × 11 (14,30. 64,5.0,9)		80 × 65 × 10 (13,60. 64,9.0,9)	
66,0	140 × 10 (14,00. 66,7.0,9) 120 × 13 (15,60. 67,0.1,0) 110 × 15 (16,50. 67,6.1,0)	75 × 75 × 10 (14,10. 66,6.1,0)		
68,0	102 × 17 (17,34. 68,8.1,2)			
70,0	130 × 12 (15,60. 71,0.1,0)		100 × 75 × 7 (11,90. 70,1.0,9)	
72,0	110 × 16 (17,60. 72,9.1,1)		100 × 50 × 10 (14,10. 73,8.0,8)	

1  
2  
3  
4  
5  
6  
7  
8  
9  
10  
11  
12  
13  
14  
15  
16  
17  
18  
19  
20  
21  
22  
23  
24  
25  
26  
27  
28  
29  
30  
31  
32  
33  
34  
35  
36  
37  
38  
39  
40

TABLE 5-1

SECTION MODULUS WITH ATTACHED PLATING OF 610mm OF STANDARD DIN SECTIONS

W cm <sup>3</sup>				
74,0	122 × 14 (17,08. 75,1. 1,0) 150 × 10 (15,00. 75,9. 1,0)	80 × 80 × 10 (15,10. 75,8. 1,1)		
76,0	130 × 13 (16,90. 77,6. 1,0)			
78,0	120 × 15 (18,00. 78,9. 1,1)	75 × 75 × 12 (16,70. 78,4. 1,2) 90 × 90 × 8 (13,90. 79,0. 1,0)	100 × 65 × 9 (14,20. 79,9. 1,0)	140 × 7 (12,60. 78,6. 1,0)
80,0	100 × 20 (20,00. 81,3. 1,4) 140 × 12 (16,80. 81,4. 1,0)			
84,0	150 × 11 (16,50. 84,1. 1,1) 130 × 14 (18,20. 84,3. 1,1) 120 × 16 (19,20. 85,0. 1,2)			140 × 8 (13,80. 84,8. 1,1)
86,0		90 × 90 × 9 (15,50. 87,9. 1,1)		
88,0		80 × 80 × 12 (17,90. 89,6. 1,3)	100 × 75 × 9 (15,10. 88,2. 1,1)	
90,0	130 × 15 (19,50. 91,1. 1,2)			
92,0	150 × 12 (18,00. 92,4. 1,1) 122 × 17 (20,74. 93,9. 1,3)			140 × 9 (15,20. 92,0. 1,1)
94,0	110 × 20 (22,00. 95,4. 1,5)		100 × 65 × 11 (17,10. 95,7. 1,2)	
98,0	130 × 16 (20,80. 98,1. 1,3)	100 × 100 × 8 (15,50. 98,0. 1,2)		
100,0	150 × 13 (19,50. 100,9. 1,2)	80 × 80 × 14 (20,60. 102,9. 1,5)		
103,0	140 × 15 (21,00. 104,2. 1,3)	90 × 90 × 11 (18,70. 105,4. 1,3)	130 × 65 × 8 (15,10. 103,2. 1,2) 100 × 75 × 11 (18,20. 105,7. 1,3) 120 × 80 × 8 (15,50. 105,7. 1,2)	
106,0				160 × 7 (14,60. 106,2. 1,3)
109,0	150 × 14 (21,00. 109,4. 1,3) 120 × 20 (24,00. 110,7. 1,5)			
112,0	140 × 16 (22,40. 112,0. 1,4)		130 × 75 × 8 (15,90. 112,6. 1,3)	
115,0				160 × 8 (16,20. 115,1. 1,4)
118,0	150 × 15 (22,50. 118,1. 1,4)	100 × 100 × 10 (19,20. 120,5. 1,4)		
121,0		90 × 90 × 13 (21,80. 122,1. 1,5)		
124,0			130 × 65 × 10 (18,60. 126,2. 1,4)	160 × 9 (17,80. 124,2. 1,4)
127,0	150 × 16 (24,00. 127,0. 1,5) 130 × 20 (26,00. 127,1. 1,6) 122 × 22 (26,84. 127,8. 1,8)		120 × 80 × 10 (19,10. 129,3. 1,4)	
136,0			130 × 75 × 10 (19,60. 137,8. 1,5)	
139,0		100 × 100 × 12 (22,70. 141,6. 1,6)		
142,0	140 × 20 (28,00. 144,8. 1,7)			
145,0		110 × 110 × 10 (21,20. 146,1. 1,6) 90 × 90 × 16 (26,40. 147,0. 1,9)	130 × 65 × 12 (22,10. 148,7. 1,5)	
150,0			150 × 75 × 9 (19,50. 152,3. 1,6) 120 × 80 × 12 (22,70. 152,7. 1,6)	180 × 8 (18,90. 154,2. 1,8)
155,0			130 × 90 × 10 (21,20. 156,8. 1,6)	
160,0	150 × 20 (30,00. 163,6. 1,8)	100 × 100 × 14 (26,20. 162,5. 1,8)	130 × 75 × 12 (23,30. 162,8. 1,7)	180 × 9 (20,70. 164,7. 1,8)
165,0	130 × 25 (32,50. 166,5. 2,1)			
170,0		110 × 110 × 12 (25,10. 171,9. 1,8)		
175,0			120 × 80 × 14 (26,20. 175,3. 1,8)	180 × 10 (22,50. 177,1. 1,9)
180,0		100 × 100 × 16 (29,60. 182,6. 2,1)	150 × 75 × 11 (23,60. 183,0. 1,8) 130 × 90 × 12 (25,10. 184,3. 1,8)	
185,0	140 × 25 (35,00. 188,8. 2,2)	120 × 120 × 11 (25,40. 189,9. 1,9)	150 × 90 × 10 (23,20. 189,9. 1,9)	180 × 11 (24,30. 189,3. 1,9)
190,0			160 × 80 × 10 (23,20. 192,7. 1,9)	

Handwritten notes on the left margin:  
 41  
 42  
 43  
 44  
 45  
 46  
 47  
 48  
 49  
 50  
 51  
 52  
 53  
 54  
 55  
 56  
 57  
 58  
 59  
 60  
 61  
 62  
 63  
 64  
 65  
 66  
 67  
 68  
 69  
 70  
 71  
 72  
 73  
 74  
 75

Handwritten notes on the right margin:  
 } PAGES 74 A  
 } VI, MOH.

TABLE 5-1

**SECTION MODULUS WITH ATTACHED PLATING OF 610mm  
OF STANDARD DIN SECTIONS**









W cm <sup>3</sup>				
195,0		110 × 110 × 14 (29,00.198,3.2,0)		
200,0			150 × 100 × 10 (24,20.203,9.2,0)	
205,0		120 × 120 × 12 (27,50.205,1.2,0)		
210,0	150 × 25 (37,50.212,6.2,3)			200 × 9 (23,60.212,5.2,4)
220,0		120 × 120 × 13 (29,70.220,7.2,2) 100 × 100 × 20 (36,20.222,5.2,5)	150 × 90 × 12 (27,50.223,7.2,1)	
225,0			160 × 80 × 12 (27,50.227,1.2,1)	200 × 10 (25,60.225,6.2,4)
240,0		130 × 130 × 12 (30,00.242,1.2,3)	150 × 100 × 12 (28,70.240,3.2,2) 180 × 90 × 10 (26,20.244,3.2,4)	200 × 11 (27,60.240,7.2,4)
250,0		120 × 120 × 15 (33,90.251,2.2,4)		200 × 12 (29,60.255,4.2,5)
258,0	150 × 30 (45,00.265,3.2,9)		160 × 80 × 14 (31,80.260,8.2,3)	
274,0		130 × 130 × 14 (34,70.278,4.2,6)	150 × 100 × 14 (33,20.276,5.2,5)	
282,0			180 × 90 × 12 (31,20.289,1.2,6)	220 × 10 (29,00.288,7.3,0)
298,0		140 × 140 × 13 (35,00.303,1.2,7)	200 × 100 × 10 (29,20.301,8.2,9)	220 × 11 (31,20.304,3.3,0)
306,0		130 × 130 × 16 (39,30.313,6.2,8)		
314,0				220 × 12 (33,40.318,5.3,0)
322,0		150 × 150 × 12 (34,80.323,9.2,9)		
330,0			180 × 90 × 14 (36,10.332,3.2,8)	
338,0		140 × 140 × 15 (40,00.344,6.3,0)		
346,0				240 × 10 (32,40.351,3.3,7)
354,0			200 × 100 × 12 (34,80.356,9.3,1)	
370,0		150 × 150 × 14 (40,30.372,3.3,2)		240 × 11 (34,90.375,7.3,7)
386,0			250 × 90 × 10 (33,20.388,7.3,9)	
394,0		150 × 150 × 15 (43,00.396,2.3,3)		240 × 12 (37,30.394,0.3,7)
410,0		150 × 150 × 16 (45,70.419,9.3,5)	200 × 100 × 14 (40,30.410,7.3,4)	
450,0		160 × 160 × 15 (46,10.452,8.3,7)		260 × 11 (38,70.455,7.4,5)
460,0		150 × 150 × 18 (51,00.467,1.3,8)	250 × 90 × 12 (39,60.460,7.4,1) 200 × 100 × 16 (45,70.463,9.3,6)	
470,0				260 × 12 (41,30.477,7.4,5)
490,0				260 × 13 (43,90.499,2.4,5)
500,0		160 × 160 × 17 (51,80.506,6.4,0)		
530,0			250 × 90 × 14 (45,90.530,9.4,4)	280 × 11 (42,60.543,7.5,5)
545,0		160 × 160 × 20 (56,30.557,6.4,3) 160 × 160 × 19 (57,50.559,3.4,3)		
560,0				280 × 12 (45,50.571,7.5,4)
590,0			250 × 90 × 16 (52,10.599,3.4,6)	280 × 13 (48,30.597,3.5,4)
605,0		180 × 180 × 16 (55,40.609,1.4,6)		
635,0				300 × 11 (46,70.647,5.6,6)
665,0		180 × 180 × 18 (61,80.677,8.5,0)		300 × 12 (49,70.679,8.6,5)
710,0				300 × 13 (52,80.711,2.6,5)
740,0		180 × 180 × 20 (68,40.744,7.5,3) 200 × 200 × 16 (61,80.752,6.5,5)		300 × 14 (55,80.740,7.6,4)
780,0				320 × 12 (54,20.793,6.7,7)
800,0		180 × 180 × 22 (74,70.809,6.5,7)		
820,0		200 × 200 × 18 (69,10.837,7.5,9)		320 × 13 (57,40.829,4.7,6)
860,0				320 × 14 (60,70.864,8.7,6)



TABLE 5-1

**SECTION MODULUS WITH ATTACHED PLATING OF 610mm  
OF STANDARD DIN SECTIONS**

W cm <sup>3</sup>				
900,0				340 × 12 (58,80.916,7.9,0)
920,0		200 × 200 × 20 (76,40.921,6.6,3)		
940,0				340 × 13 (62,20.958,6.8,9)
980,0				340 × 14 (65,50.997,4.8,8)
1030,0				340 × 15 (68,90.1035,7.8,7)
1060,0		200 × 200 × 24 (90,60.1083,2.7,1)		
1150,0				370 × 13 (69,60.1179,7.11,1)
1210,0				370 × 14 (73,30.1219,9.10,9)
1240,0		200 × 200 × 28 (105,0.1244,6.7,9)		370 × 15 (77,00.1267,5.10,8)
1300,0				370 × 16 (80,70.1312,9.10,7)
1450,0				400 × 14 (81,40.1488,6.13,5)
1500,0				400 × 15 (85,40.1535,8.13,2)
1550,0				400 × 16 (89,40.1591,4.13,1)
1600,0				400 × 17 (93,40.1633,6.12,9)
1800,0				430 × 15 (94,10.1833,2.16,1)
1950,0				430 × 17 (103,00.1954,5.15,6)
2050,0				430 × 19 (111,00.2069,9.15,2)
2150,0				430 × 21 (120,00.2188,6.15,1)



# **MARS2000**

## **New Ship**

**Cross Section Characteristics**  
**Gross scantling**

**Geometric Properties (For the whole cross-section)**

**Geometric Area of Cross-Section**

	Steel (235)	Steel (355)	Total Area
Strakes	1.357719	0.000000	1.357719
Longitudinals	0.313916	0.054286	0.368202
Total (m <sup>2</sup> )	1.671639	0.054286	1.725921

Geometric area of cross-section .....	1.725926	m <sup>2</sup>
Effective area .....	1.267486	m <sup>2</sup>
Single moment above neutral axis .....	( / neutral axis) ... 2.368181	m <sup>3</sup>
Single moment of half section .....	( / centre line) ... 3.328110	m <sup>3</sup>
Moment of inertia / G <sub>y</sub> axis .....	(IG <sub>y</sub> ) .. 24.476110	m <sup>4</sup>
Moment of inertia / G <sub>z</sub> axis .....	(IG <sub>z</sub> ) .. 46.875160	m <sup>4</sup>
Position of neutral axis .....	(above base line) .... (N) .... 4.97048	m
Modulus at deck .....	(3.800 m) .. (Z <sub>AD</sub> ) .. -20.911100	m <sup>3</sup>
Modulus at bottom .....	(0.000 m) ... (Z <sub>AB</sub> ) ... 4.924292	m <sup>3</sup>
Modulus at top .....	(Z <sub>Vt</sub> = 15.900 m) ... (Z <sub>AT</sub> ) ... 2.239451	m <sup>3</sup>
(Z <sub>Vt</sub> = 15.900 m; V <sub>t</sub> = 10.930 m; Y <sub>t</sub> = 10.000 m; Z <sub>t</sub> = 15.900 m)		
Transverse sectional area of deck flange .....	0.783859	m <sup>2</sup>
Transverse sectional area of bottom flange .....	0.189984	m <sup>2</sup>

These characteristic (except geometric area) are effective values assuming an homogeneous material of 206000 (N/mm<sup>2</sup>) as Young modulus.

**Profiles**

Type	Scantling	Number
flat	150 × 20.0	4
flat	150 × 10.0	6
flat	100 × 10.0	4
bulb	220 × 10.0	30
bulb	180 × 8.0	4
bulb	180 × 10.0	16
bulb	160 × 8.0	4
bulb	140 × 9.0	2
bulb	140 × 8.0	16
bulb	140 × 7.0	2

Type	Scantling				Number
bulb	120	×	8.0		6
bulb	120	×	7.0		2
bulb	100	×	6.0		138
t-bar	620	×	8.0	150 × 20.0	4
t-bar	600	×	12.0	150 × 20.0	1
t-bar	450	×	7.0	100 × 10.0	4
t-bar	350	×	7.0	150 × 10.0	1

**Strakes**

Thickness (mm)	Length (m)
12.500	2.150
12.000	1.100
11.000	22.501
10.500	1.682
10.000	15.392
8.500	6.115
8.000	23.361
7.500	5.507
7.000	6.640
6.000	99.184

The length indicated is the total length for the strakes having same thickness.

**Hull Girder Loads**

**Vertical Bending Moment**

	Hogging (kNm)	Sagging (kNm)
S.W.B.M. Builder's proposal in Basic Ship Data . . . . .	38 785.	- 38 785.
S.W.B.M. Builder's proposal at X = 46.35 m . . . . .	-	-
S.W.B.M. preliminary value at midship . . . . .	141 427.	- 113 018.
S.W.B.M. preliminary value at X = 46.35 m . . . . .	141 427.	- 113 018.
Rule Vertical Wave Bending Moment at X = 46.35 m . .	114 693.	- 143 102.

**Design Hull Girder Loads at X = 46.35 m**

	Hogging (kNm)	Sagging (kNm)
S.W.B.M. . . . .	38 785.	- 38 785.
Wave bending moment (Rule) . . . . .	114 693.	- 143 102.
Horizontal wave bending moment . . . . .	19 670.	

	Positive (KN)	Negative (KN)
Vertical still water shear force . . . . .	1 800.	
Vertical wave shear force . . . . .	3 038.	- 3 038.

**Admissible Vertical Shear Forces**

Total Admissible Vert. Shear Force . . . . . (KN) . . . . .	16 037.
Positive Admissible Vert. Still Water Shear Force . . . . . (KN) . . . . .	12 999.
Negative Admissible Vert. Still Water Shear Force . . . . . (KN) . . . . .	12 999.

**Section moduli and Inertia**

X section . . . . .	46.350 (m)
X mid, defining midship section (+/- 0.1 m) . . . . .	44.960 (m)
X mid - 0.2 L . . . . .	26.976 (m)
X mid + 0.2 L . . . . .	62.944 (m)

Minimum section modulus at midship section (k = 1, n<sub>1</sub> = 0.9) . . . . . 1.4635 (m<sup>3</sup>)

**Rule section moduli**

	Deck (m <sup>3</sup> )	Bottom (m <sup>3</sup> )	Top (m <sup>3</sup> )
Modulus based on design BM, Hog. ( 153 477.5 kNm) . . . . .	0.8770	0.8770	0.8770
Modulus based on design BM, Sag. (- 181 886.6 kNm) . . . . .	1.0394	1.0394	1.0394
Rule Modulus . . . . .	1.0394	1.0394	1.0394

**Check of section moduli and inertia**

	Rule	Actual
Deck ( 3.800 m k = 1.00)	1.0394	-20.9111
Bottom ( 0.000 m k = 1.00)	1.0394	4.9243
Top ( 15.900 m k = 1.00)	1.0394	2.2395
Inertia	3.5094	24.4761

**Check of Net/Gross Moduli**

	Actual Gross	Actual Net	%
Deck . . . . . ( 3.800 m)	-20.9111	-20.3350	97.2
Bottom . . . . . ( 0.000 m)	4.9243	4.2693	86.7
Top . . . . . ( 15.900 m)	2.2395	1.8516	82.7

**Local Rule Requirements - Strake**

N°	tGActu.	tGRule	tGRuleBuck	Mat	Spac	Span	Bend.Eff.
	tNetActu.	tLoad	SigX1	ps	pw	Case	Tau1
CAdd		tTest	$\sigma_N$ Actu.	$\sigma_N$ Rule		Case	$\sigma_{Ap}$ Buck
		tMini	$\tau_N$ Actu.	$\tau_N$ Rule		Case	$\tau_{Ap}$ Buck
							$\sigma_{CRIT}$ Buck
							$\tau_{CRIT}$ Buck

1 - Outer shell

1	11.00	11.00	5.00			ST235	0.600	2.850	100
	10.00	4.21	31.96	25.14	13.09	SEA-a1	1.45		
		0.00	36.94	175.00		a	-27.35	-149.97	
1.00		10.10	1.63	110.00		a	1.79	106.55	

2	10.00	8.50	5.00			ST235	0.650	3.000	100
	9.00	4.26	30.35	22.63	13.32	SEA-a1	6.68		
		0.00	36.94	175.00		a	-27.35	-136.01	
1.00		0.00	10.36	110.00		a	10.24	102.86	

3	8.50	8.50	3.50			ST235	0.700	3.000	100
	7.50	3.88	23.30	11.60	14.38	SEA-a1	11.40		
		0.00	27.75	175.00		a	-21.66	-149.87	
1.00		0.00	14.02	110.00		a	12.73	92.81	

**Local Rule Requirements - Strake**

N°	tGActu.	tGRule	tGRuleBuck	Mat	Spac	Span	Bend.Eff.
	tNetActu.	tLoad	SigX1	ps	pw	Case	Tau1
CAdd		tTest	$\sigma_N$ Actu.	$\sigma_N$ Rule		Case	$\sigma_{Ap}$ Buck $\sigma_{CRIT}$ Buck
		tMini	$\tau_N$ Actu.	$\tau_N$ Rule		Case	$\tau_{Ap}$ Buck $\tau_{CRIT}$ Buck

2 - Tank top

4	8.00	7.50	4.50			ST235	0.600	2.850	100
	7.00	6.24	25.14	9.81	1.56	Wheel-b		5.74	
		0.00	29.13	175.00		a		-21.55	-90.41
1.00		6.50	7.22	110.00		a		5.94	91.59



**Local Rule Requirements - Strake**

N°	tGActu.	tGRule	tGRuleBuck	Mat	Spac	Span	Bend.Eff.
	tNetActu.	tLoad	SigX1	ps	pw	Case	Tau1
CAdd		tTest	$\sigma_N$ Actu.	$\sigma_N$ Rule		Case	$\sigma_{Ap}$ Buck $\sigma_{CRIT}$ Buck
		tMini	$\tau_N$ Actu.	$\tau_N$ Rule		Case	$\tau_{Ap}$ Buck $\tau_{CRIT}$ Buck

3 - Main deck

5	11.00	9.50	3.00			ST235	0.600	3.000	100
	10.00	8.65	7.48	24.53	3.89	Wheel-b		9.21	
		0.00	8.70	175.00		c		-7.16	-150.80
1.00		4.90	10.20	110.00		c		9.27	106.49

**Local Rule Requirements - Strake**

N°	tGActu.	tGRule	tGRuleBuck	Mat	Spac	Span	Bend.Eff.
	tNetActu.	tLoad	SigX1	ps	pw	Case	Tau1
CAdd		tTest	$\sigma_N$ Actu.	$\sigma_N$ Rule		Case	$\sigma_{Ap}$ Buck
		tMini	$\tau_N$ Actu.	$\tau_N$ Rule		Case	$\tau_{Ap}$ Buck
							$\sigma_{CRIT}$ Buck
							$\tau_{CRIT}$ Buck

4 - Passenger deck

6	6.00	6.00	5.00			ST235	0.600	3.000	100
	5.00	2.23	28.80	4.20	5.88	SEA-a1	28.37		
		0.00	33.29	175.00		a	-28.80	-46.09	
1.00		4.90	31.09	110.00		a	25.05	63.23	

7	8.00	6.00	5.00			ST235	0.600	3.000	100
	7.00	2.23	28.80	4.20	5.88	SEA-a1	28.37		
		0.00	33.28	175.00		a	-28.80	-90.41	
1.00		4.90	26.70	110.00		a	25.05	91.49	

**Local Rule Requirements - Strake**

N°	tGActu.	tGRule	tGRuleBuck	Mat	Spac	Span	Bend.Eff.
	tNetActu.	tLoad	SigX1	ps	pw	Case	Tau1
CAdd		tTest	$\sigma_N$ Actu.	$\sigma_N$ Rule		Case	$\sigma_{Ap}$ Buck $\sigma_{CRIT}$ Buck
		tMini	$\tau_N$ Actu.	$\tau_N$ Rule		Case	$\tau_{Ap}$ Buck $\tau_{CRIT}$ Buck

5 - Sun deck

8	6.00	4.50	5.50			ST235	0.600	3.000	65
	4.80	1.91	30.42	3.15	4.41	SEA-a1		3.47	
		0.00	35.16	175.00		a		-30.42	-42.48
1.20		3.36	7.74	110.00		a		6.30	58.41

**Local Rule Requirements - Strake**

N°	tGActu.	tGRule	tGRuleBuck	Mat	Spac	Span	Bend.Eff.
	tNetActu.	tLoad	SigX1	ps	pw	Case	Tau1
CAdd		tTest	$\sigma_N$ Actu.	$\sigma_N$ Rule		Case	$\sigma_{Ap}$ Buck $\sigma_{CRIT}$ Buck
		tMini	$\tau_N$ Actu.	$\tau_N$ Rule		Case	$\tau_{Ap}$ Buck $\tau_{CRIT}$ Buck

6 - Wheelhouse deck

9	6.00	4.50	3.00			ST235	0.600	3.000	10
	5.00	1.45	7.06	1.87	2.62	SEA-a1	0.80		
		0.00	8.16	175.00		a	-7.06	-46.09	
1.00		3.36	1.67	110.00		a	1.35	63.25	

**Local Rule Requirements - Strake**

N°	tGActu.	tGRule tGRuleBuck				Mat	Spac	Span	Bend.Eff.
CAdd	tNetActu.	tLoad	SigX1	ps	pw	Case	Tau1		
		tTest	$\sigma_N$ Actu.	$\sigma_N$ Rule		Case	$\sigma_{Ap}$ Buck	$\sigma_{CRIT}$ Buck	
		tMini	$\tau_N$ Actu.	$\tau_N$ Rule		Case	$\tau_{Ap}$ Buck	$\tau_{CRIT}$ Buck	

7 - Inner Side 6000

10	10.50	7.50	5.50			ST235	0.700	3.000	100
	9.50	4.28	17.89	27.65	7.06	FLOOD 1-Floo	2.66		
1.00		0.00	35.08	175.00		a	-25.98	-114.84	
		6.02	6.46	110.00		a	7.28	99.40	

11	7.50	7.50	5.00			ST235	0.700	3.000	100
	6.50	4.28	17.89	27.65	7.06	FLOOD 1-Floo	2.66		
1.00		0.00	28.83	175.00		a	-21.57	-62.55	
		6.02	10.30	110.00		a	9.32	64.38	

12	7.50	7.50	4.50			ST235	0.780	3.000	100
	6.50	3.71	11.50	13.57	7.06	FLOOD 1-Floo	4.15		
1.00		0.00	13.97	175.00		a	-13.87	-54.06	
		6.38	10.64	110.00		a	9.32	64.38	

**Local Rule Requirements - Strake**

N°	tGActu.	tGRule	tGRuleBuck	Mat	Spac	Span	Bend.Eff.
	tNetActu.	tLoad	SigX1	ps	pw	Case	Tau1
CAdd		tTest	$\sigma_N$ Actu.	$\sigma_N$ Rule		Case	$\sigma_{Ap}$ Buck $\sigma_{CRIT}$ Buck
		tMini	$\tau_N$ Actu.	$\tau_N$ Rule		Case	$\tau_{Ap}$ Buck $\tau_{CRIT}$ Buck

8 - Superstructure side

13	6.00	0.00	6.50		ST235	0.000	0.000	30
	4.80	0.00						
		0.00	24.48	175.00	a	-19.35	* -14.75	
1.20		0.00	21.93	110.00	a	19.63	58.66	

**Local Rule Requirements - Strake**

N°	tGActu.	tGRule	tGRuleBuck	Mat	Spac	Span	Bend.Eff.	
	tNetActu.	tLoad	SigX1	ps	pw	Case	Tau1	
CAdd		tTest	$\sigma_N$ Actu.	$\sigma_N$ Rule		Case	$\sigma_{Ap}$ Buck	$\sigma_{CRIT}$ Buck
		tMini	$\tau_N$ Actu.	$\tau_N$ Rule		Case	$\tau_{Ap}$ Buck	$\tau_{CRIT}$ Buck

9 - Superstructure top

14	6.00	0.00	4.50		ST235	0.000	0.000	30
	4.80	0.00						
		0.00	22.47	175.00	a	-19.44	-42.48	
1.20		0.00	4.92	110.00	a	4.01	58.41	

**Local Rule Requirements - Strake**

N°	tGActu.	tGRule	tGRuleBuck	Mat	Spac	Span	Bend.Eff.
	tNetActu.	tLoad	SigX1	ps	pw	Case	Tau1
CAdd		tTest	$\sigma_N$ Actu.	$\sigma_N$ Rule		Case	$\sigma_{Ap}$ Buck $\sigma_{CRIT}$ Buck
		tMini	$\tau_N$ Actu.	$\tau_N$ Rule		Case	$\tau_{Ap}$ Buck $\tau_{CRIT}$ Buck

10 - Sun deck side

15	6.00	0.00	0.00		ST235	0.000	0.000	0
	5.00	0.00						
		0.00	0.00	175.00		0.00	0.00	
1.00		0.00	0.00	110.00		0.00	0.00	



**Local Rule Requirements - Strake**

N°	tGActu.	tGRule	tGRuleBuck	Mat	Spac	Span	Bend.Eff.
	tNetActu.	tLoad	SigX1	ps	pw	Case	Tau1
CAdd		tTest	$\sigma_N$ Actu.	$\sigma_N$ Rule		Case	$\sigma_{Ap}$ Buck
		tMini	$\tau_N$ Actu.	$\tau_N$ Rule		Case	$\tau_{Ap}$ Buck
							$\sigma_{CRIT}$ Buck
							$\tau_{CRIT}$ Buck

11 - Wheelhouse deck side

16	6.00	0.00	0.00		ST235	0.000	0.000	0
	5.00	0.00						
		0.00	0.00	175.00		0.00	0.00	
1.00		0.00	0.00	110.00		0.00	0.00	

**Local Rule Requirements - Strake**

N°	tGActu.	tGRule	tGRuleBuck	Mat	Spac	Span	Bend.Eff.
	tNetActu.	tLoad	SigX1	ps	pw	Case	Tau1
CAdd		tTest	$\sigma_N$ Actu.	$\sigma_N$ Rule		Case	$\sigma_{Ap}$ Buck
		tMini	$\tau_N$ Actu.	$\tau_N$ Rule		Case	$\tau_{Ap}$ Buck
							$\sigma_{CRIT}$ Buck
							$\tau_{CRIT}$ Buck

12 - Side girder 3000

17	12.50	7.50	6.50		ST235	0.000	0.000	100
	11.50	0.00						
		0.00	36.92	175.00	a	-27.34	-124.15	
1.00		0.00	0.78	110.00	a	0.41	111.82	

**Local Rule Requirements - Strake**

N°	tGActu.	tGRule	tGRuleBuck	Mat	Spac	Span	Bend.Eff.
	tNetActu.	tLoad	SigX1	ps	pw	Case	Tau1
CAdd		tTest	$\sigma_N$ Actu.	$\sigma_N$ Rule		Case	$\sigma_{Ap}$ Buck $\sigma_{CRIT}$ Buck
		tMini	$\tau_N$ Actu.	$\tau_N$ Rule		Case	$\tau_{Ap}$ Buck $\tau_{CRIT}$ Buck

13 - Centar girder

18	12.00	6.00	6.00		ST235	0.000	0.000	100
	11.00	0.00						
		0.00	36.94	175.00	a	-27.35	-129.07	
1.00		0.00	0.81	110.00	a	0.42	110.89	

**Local Rule Requirements - Strake**

N°	tGActu.	tGRule	tGRuleBuck	Mat	Spac	Span	Bend.Eff.
	tNetActu.	tLoad	SigX1	ps	pw	Case	Tau1
CAdd		tTest	$\sigma_N$ Actu.	$\sigma_N$ Rule		Case	$\sigma_{Ap}$ Buck $\sigma_{CRIT}$ Buck
		tMini	$\tau_N$ Actu.	$\tau_N$ Rule		Case	$\tau_{Ap}$ Buck $\tau_{CRIT}$ Buck

14 - Wheelhouse top

19	6.00	0.00	0.00		ST235	0.000	0.000	0
	5.00	0.00						
		0.00	0.00	175.00			0.00	0.00
1.00		0.00	0.00	110.00			0.00	0.00

**Local Rule Requirements - Strake**

N°	tGActu.	tGRule	tGRuleBuck	Mat	Spac	Span	Bend.Eff.	
	tNetActu.	tLoad	SigX1	ps	pw	Case	Tau1	
CAdd		tTest	$\sigma_N$ Actu.	$\sigma_N$ Rule		Case	$\sigma_{Ap}$ Buck	$\sigma_{CRIT}$ Buck
		tMini	$\tau_N$ Actu.	$\tau_N$ Rule		Case	$\tau_{Ap}$ Buck	$\tau_{CRIT}$ Buck

15 - Wheelhouse side

20	6.00	0.00	0.00			ST235	0.000	0.000	0
	5.50	0.00							
		0.00	0.00	175.00			0.00	0.00	
0.50		0.00	0.00	110.00			0.00	0.00	

**Local Rule Requirements - Strake**

N°	tGActu.	tGRule	tGRuleBuck	Mat	Spac	Span	Bend.Eff.
	tNetActu.	tLoad	SigX1	ps	pw	Case	Tau1
CAdd		tTest	$\sigma_N$ Actu.	$\sigma_N$ Rule		Case	$\sigma_{AP}$ Buck
		tMini	$\tau_N$ Actu.	$\tau_N$ Rule		Case	$\tau_{AP}$ Buck
							$\sigma_{CRIT}$ Buck
							$\tau_{CRIT}$ Buck

16 - Outer shell,plitted

21	8.00	7.50	5.00			ST235	0.700	3.000	100
	7.00	2.66	7.53	0.00	10.11	SEA-a1		26.46	
		0.00	8.70	175.00		c		-7.16	-78.23
1.00		6.42	29.03	110.00		c		28.46	81.29

22	7.00	7.50	5.00			ST235	0.700	3.000	100
	6.00	2.66	5.98	0.00	10.11	SEA-a1		30.26	
		0.00	21.55	175.00		a		-19.48	-54.80
1.00		6.42	33.19	110.00		a		30.32	66.97

23	8.00	7.50	5.50			ST235	0.700	3.000	100
	7.00	2.32	14.98	0.00	7.58	SEA-a1		29.76	
		0.00	33.66	175.00		a		-28.48	-62.89
1.00		6.42	28.21	110.00		a		27.75	81.29

**Local Rule Requirements - Stiffener**

N°	WGActu.	H <sub>1</sub>	E <sub>1</sub>	H <sub>2</sub>	E <sub>2</sub>	Mat	Spac	Span	Bend.Eff.
	WNetActu.	WNetRule	SigX1	ps	pw	Case			
	ANetActu.	ANetRule	SigX1	ps	pw	Case			
		SigU	SigX1	ps	pw	Case			
CAdd	DFatActu.	DFatRule				Case		sigApBu	sigCritBu

1 - Outer shell

1	178.79	180.0	10.0	0.0	0.0	ST235	0.600	2.850	100
	166.32	74.76	27.35	25.14	13.09	SEA-a1			
	16.20	2.77		25.14	13.09	SEA-a1			
0.50		157.88	29.78	25.14	13.09	SEA-a1			
						a		-27.35	-194.22
2	178.79	180.0	10.0	0.0	0.0	ST235	0.600	2.850	100
	166.32	74.76	27.35	25.14	13.09	SEA-a1			
	16.20	2.77		25.14	13.09	SEA-a1			
0.50		157.88	29.78	25.14	13.09	SEA-a1			
						a		-27.35	-194.22
3	176.97	180.0	10.0	0.0	0.0	ST235	0.600	2.850	100
	164.57	74.76	27.35	25.14	13.09	SEA-a1			
	16.20	2.77		25.14	13.09	SEA-a1			
0.50		154.92	29.78	25.14	13.09	SEA-a1			
						a		-27.35	-194.95
4	176.96	180.0	10.0	0.0	0.0	ST235	0.600	2.850	100
	164.56	74.76	27.35	25.14	13.09	SEA-a1			
	16.20	2.77		25.14	13.09	SEA-a1			
0.50		154.92	29.78	25.14	13.09	SEA-a1			
						a		-27.35	-194.95
5	176.84	180.0	10.0	0.0	0.0	ST235	0.601	2.850	100
	164.45	74.48	27.25	24.95	13.10	SEA-a1			
	16.19	2.76		24.95	13.10	SEA-a1			
0.50		155.04	29.66	24.95	13.10	SEA-a1			
						a		-27.25	-194.95
6	176.51	180.0	10.0	0.0	0.0	ST235	0.602	2.850	100
	164.15	73.97	27.06	24.61	13.14	SEA-a1			
	16.16	2.74		24.61	13.14	SEA-a1			
0.50		155.26	29.46	24.61	13.14	SEA-a1			
						a		-27.06	-194.93
7	175.99	180.0	10.0	0.0	0.0	ST235	0.604	2.850	100
	163.66	73.17	26.76	24.06	13.19	SEA-a1			
	16.11	2.72		24.06	13.19	SEA-a1			
0.50		155.61	29.13	24.06	13.19	SEA-a1			
						a		-26.76	-194.91

**Local Rule Requirements - Stiffener**

N°	WGActu.	H <sub>1</sub>	E <sub>1</sub>	H <sub>2</sub>	E <sub>2</sub>	Mat	Spac	Span	Bend.Eff.
	WNetActu.	WNetRule	SigX1	ps	pw	Case			
	ANetActu.	ANetRule	SigX1	ps	pw	Case			
		SigU	SigX1	ps	pw	Case			
CAdd	DFatActu.	DFatRule				Case		sigApBu	sigCritBu

1 - Outer shell

8	175.01	180.0	10.0	0.0	0.0	ST235	0.555	2.850	100
	162.77	66.58	26.34	23.30	13.26	SEA-a1			
	16.10	2.48		23.30	13.26	SEA-a1			
0.50		156.60	28.68	23.30	13.26	SEA-a1			
						a		-26.34	-195.52
9	158.01	180.0	8.0	0.0	0.0	ST235	0.650	3.000	100
	145.76	81.32	25.31	21.40	13.43	SEA-a1			
	12.60	2.89		21.40	13.43	SEA-a1			
0.50		151.91	27.55	21.40	13.43	SEA-a1			
						a		-25.31	-191.66
10	158.01	180.0	8.0	0.0	0.0	ST235	0.650	3.000	100
	145.76	77.62	24.36	19.67	13.59	SEA-a1			
	12.60	2.77		19.67	13.59	SEA-a1			
0.50		153.24	26.52	19.67	13.59	SEA-a1			
						a		-24.36	-191.66
11	117.92	160.0	8.0	0.0	0.0	ST235	0.650	3.000	100
	109.05	72.92	23.14	17.44	13.81	SEA-a1			
	11.20	2.62		17.44	13.81	SEA-a1			
0.50		143.48	25.19	17.44	13.81	SEA-a1			
						a		-23.14	-184.16
12	117.92	160.0	8.0	0.0	0.0	ST235	0.650	3.000	100
	109.05	67.30	21.66	14.73	14.07	SEA-a1			
	11.20	2.43		14.73	14.07	SEA-a1			
0.50		145.91	23.58	14.73	14.07	SEA-a1			
						a		-21.66	-184.16
13	91.86	140.0	9.0	0.0	0.0	ST235	0.675	3.000	100
	83.79	62.95	19.94	11.60	14.38	SEA-a1			
	11.20	2.30		11.60	14.38	SEA-a1			
0.50		127.24	21.71	11.60	14.38	SEA-a1			
						a		-19.94	-176.15
14	80.47	140.0	7.0	0.0	0.0	ST235	0.700	3.000	100
	71.60	56.04	17.64	7.40	14.80	SEA-a1			
	8.40	2.07		7.40	14.80	SEA-a1			
0.50		129.42	19.21	7.40	14.80	SEA-a1			
						a		-17.64	-171.94



**Local Rule Requirements - Stiffener**

N°	WGActu.		H <sub>1</sub>	E <sub>1</sub>	H <sub>2</sub>	E <sub>2</sub>	Mat	Spac	Span	Bend.Eff.
	WNetActu.	WNetRule	SigX1	ps	pw		Case			
	ANetActu.	ANetRule		ps	pw		Case			
		SigU	SigX1	ps	pw		Case			
CAdd	DFatActu.	DFatRule					Case		sigApBu	sigCritBu

1 - Outer shell

15	62.60		120.0	8.0	0.0	0.0	ST235	0.725	3.000	100
	56.67	44.70	14.28	1.24	15.45		SEA-a1			
	8.40	1.67		1.24	15.45		SEA-a1			
0.50		112.77	15.54	1.24	15.45		SEA-a1			
							a		-14.28	-153.76
16	62.58		120.0	8.0	0.0	0.0	ST235	0.720	3.000	100
	56.65	26.74	10.24	0.00	10.11		SEA-a1			
	8.40	1.02		0.00	10.11		SEA-a1			
0.50		127.50	11.15	0.00	10.11		SEA-a1			
							a		-10.24	-154.01

**Local Rule Requirements - Stiffener**

N°	WGActu.	H <sub>1</sub>	E <sub>1</sub>	H <sub>2</sub>	E <sub>2</sub>	Mat	Spac	Span	Bend.Eff.
	WNetActu.	WNetRule	SigX1	ps	pw	Case			
	ANetActu.	ANetRule	SigX1	ps	pw	Case			
		SigU	SigX1	ps	pw	Case			
CAdd	DFatActu.	DFatRule				Case		sigApBu	sigCritBu

2 - Tank top

1	84.72	140.0	8.0	0.0	0.0	ST235	0.600	2.850	100
	76.80	60.31	17.66	27.15	7.06	FLOOD 1-Flood			
	9.80	2.34		27.15	7.06	FLOOD 1-Flood			
		103.45	16.64	27.15	7.06	FLOOD 1-Flood			
0.50						a		-21.30	-181.40
2	84.72	140.0	8.0	0.0	0.0	ST235	0.600	2.850	100
	76.80	60.41	17.68	27.20	7.06	FLOOD 1-Flood			
	9.80	2.34		27.20	7.06	FLOOD 1-Flood			
		103.35	16.66	27.20	7.06	FLOOD 1-Flood			
0.50						a		-21.33	-181.40
3	84.72	140.0	8.0	0.0	0.0	ST235	0.600	2.850	100
	76.80	60.52	17.71	27.26	7.06	FLOOD 1-Flood			
	9.80	2.35		27.26	7.06	FLOOD 1-Flood			
		103.23	16.69	27.26	7.06	FLOOD 1-Flood			
0.50						a		-21.36	-181.40
4	84.72	140.0	8.0	0.0	0.0	ST235	0.600	2.850	100
	76.80	60.63	17.73	27.32	7.06	FLOOD 1-Flood			
	9.80	2.35		27.32	7.06	FLOOD 1-Flood			
		103.11	16.71	27.32	7.06	FLOOD 1-Flood			
0.50						a		-21.39	-181.40
5	84.72	140.0	8.0	0.0	0.0	ST235	0.600	2.850	100
	76.80	60.84	17.79	27.43	7.06	FLOOD 1-Flood			
	9.80	2.36		27.43	7.06	FLOOD 1-Flood			
		102.90	16.76	27.43	7.06	FLOOD 1-Flood			
0.50						a		-21.45	-181.40
6	84.72	140.0	8.0	0.0	0.0	ST235	0.600	2.850	100
	76.80	60.95	17.81	27.49	7.06	FLOOD 1-Flood			
	9.80	2.36		27.49	7.06	FLOOD 1-Flood			
		102.78	16.78	27.49	7.06	FLOOD 1-Flood			
0.50						a		-21.48	-181.40
7	84.72	140.0	8.0	0.0	0.0	ST235	0.600	2.850	100
	76.80	61.06	17.84	27.55	7.06	FLOOD 1-Flood			
	9.80	2.37		27.55	7.06	FLOOD 1-Flood			
		102.67	16.81	27.55	7.06	FLOOD 1-Flood			
0.50						a		-21.52	-181.40

**Local Rule Requirements - Stiffener**

N°	WGActu.		H <sub>1</sub>	E <sub>1</sub>	H <sub>2</sub>	E <sub>2</sub>	Mat	Spac	Span	Bend.Eff.
	WNetActu.	WNetRule	SigX1	ps	pw		Case			
	ANetActu.	ANetRule		ps	pw		Case			
		SigU	SigX1	ps	pw		Case			
CAdd	DFatActu.	DFatRule					Case		sigApBu	sigCritBu

2 - Tank top

8	84.34		140.0	8.0	0.0	0.0	ST235	0.550	2.850	100
	76.46	56.62	17.86	27.60	7.06		FLOOD 1-Flood			
	9.80	2.20		27.60	7.06		FLOOD 1-Flood			
		110.04	16.83	27.60	7.06		FLOOD 1-Flood			
0.50							a		-21.55	-182.80

**Local Rule Requirements - Stiffener**

N°	WActu.	H <sub>1</sub>	E <sub>1</sub>	H <sub>2</sub>	E <sub>2</sub>	Mat	Spac	Span	Bend.Eff.
	WNetActu.	WNetRule	SigX1	ps	pw	Case			
	ANetActu.	ANetRule	SigX1	ps	pw	Case			
		SigU	SigX1	ps	pw	Case			
CAdd	DFatActu.	DFatRule				Case		sigApBu	sigCritBu

3 - Main deck

1	2730.21	600.0	12.0	150.0	20.0	ST235	0.600	3.000	100
	2548.86	136.01	6.88	24.53	3.89	Wheel-b			
	66.11	6.11		24.53	3.89	Wheel-b			
		195.12	6.41	15.00	4.76	UniCarg-b			
0.50						a		-5.89	-162.35
2	291.25	220.0	10.0	0.0	0.0	ST235	0.600	3.000	100
	270.30	136.01	6.88	24.53	3.89	Wheel-b			
	19.80	6.11		24.53	3.89	Wheel-b			
		179.33	6.41	15.00	4.76	UniCarg-b			
0.50						a		-5.89	-196.09
3	291.23	220.0	10.0	0.0	0.0	ST235	0.600	3.000	100
	270.28	136.04	6.92	24.53	3.89	Wheel-b			
	19.80	6.11		24.53	3.89	Wheel-b			
		179.33	6.45	15.00	4.76	UniCarg-b			
0.50						a		-5.92	-196.09
4	291.23	220.0	10.0	0.0	0.0	ST235	0.600	3.000	100
	270.28	136.06	6.96	24.53	3.89	Wheel-b			
	19.80	6.11		24.53	3.89	Wheel-b			
		179.33	6.49	15.00	4.76	UniCarg-b			
0.50						a		-5.96	-196.09
5	291.23	220.0	10.0	0.0	0.0	ST235	0.600	3.000	100
	270.28	136.09	7.00	24.53	3.89	Wheel-b			
	19.80	6.11		24.53	3.89	Wheel-b			
		179.33	6.53	15.00	4.76	UniCarg-b			
0.50						a		-5.99	-196.09
6	291.23	220.0	10.0	0.0	0.0	ST235	0.600	3.000	100
	270.28	136.11	7.04	24.53	3.89	Wheel-b			
	19.80	6.11		24.53	3.89	Wheel-b			
		179.33	6.56	15.00	4.76	UniCarg-b			
0.50						a		-6.03	-196.09
7	291.23	220.0	10.0	0.0	0.0	ST235	0.600	3.000	100
	270.28	136.14	7.09	24.53	3.89	Wheel-b			
	19.80	6.11		24.53	3.89	Wheel-b			
		179.33	6.60	15.00	4.76	UniCarg-b			
0.50						a		-6.06	-196.09

**Local Rule Requirements - Stiffener**

N°	WGActu.	H <sub>1</sub>	E <sub>1</sub>	H <sub>2</sub>	E <sub>2</sub>	Mat	Spac	Span	Bend.Eff.
	WNetActu.	WNetRule	SigX1	ps	pw	Case			
	ANetActu.	ANetRule	SigX1	ps	pw	Case			
		SigU	SigX1	ps	pw	Case			
CAdd	DFatActu.	DFatRule				Case		sigApBu	sigCritBu

3 - Main deck

8	291.23	220.0	10.0	0.0	0.0	ST235	0.600	3.000	100
	270.28	136.16	7.13	24.53	3.89	Wheel-b			
	19.80	6.11		24.53	3.89	Wheel-b			
0.50		179.33	6.64	15.00	4.76	UniCarg-b			
						a		-6.10	-196.09
9	291.23	220.0	10.0	0.0	0.0	ST235	0.600	3.000	100
	270.28	136.19	7.17	24.53	3.89	Wheel-b			
	19.80	6.11		24.53	3.89	Wheel-b			
0.50		179.33	6.68	15.00	4.76	UniCarg-b			
						a		-6.13	-196.09
10	289.56	220.0	10.0	0.0	0.0	ST235	0.550	3.000	100
	268.76	132.46	7.21	24.53	3.89	Wheel-b			
	19.80	5.94		24.53	3.89	Wheel-b			
0.50		179.39	6.72	15.00	4.76	UniCarg-b			
						a		-6.17	-196.54
11	291.23	220.0	10.0	0.0	0.0	ST235	0.600	3.000	100
	270.28	136.26	7.29	24.53	3.89	Wheel-b			
	19.80	6.11		24.53	3.89	Wheel-b			
0.50		179.33	6.79	15.00	4.76	UniCarg-b			
						a		-6.24	-196.09
12	291.23	220.0	10.0	0.0	0.0	ST235	0.600	3.000	100
	270.28	136.29	7.33	24.53	3.89	Wheel-b			
	19.80	6.11		24.53	3.89	Wheel-b			
0.50		179.33	6.83	15.00	4.76	UniCarg-b			
						a		-6.27	-196.09
13	291.23	220.0	10.0	0.0	0.0	ST235	0.600	3.000	100
	270.28	136.31	7.37	24.53	3.89	Wheel-b			
	19.80	6.11		24.53	3.89	Wheel-b			
0.50		177.26	6.87	15.00	7.14	UniCarg-d+			
						c		-6.31	-196.09
14	291.23	220.0	10.0	0.0	0.0	ST235	0.600	3.000	100
	270.28	136.34	7.41	24.53	3.89	Wheel-b			
	19.80	6.11		24.53	3.89	Wheel-b			
0.50		176.82	7.12	15.00	7.66	UniCarg-d+			
						c		-6.54	-196.09

**Local Rule Requirements - Stiffener**

N°	WGActu.		H <sub>1</sub>	E <sub>1</sub>	H <sub>2</sub>	E <sub>2</sub>	Mat	Spac	Span	Bend.Eff.
	WNetActu.	WNetRule	SigX1	ps	pw		Case			
	ANetActu.	ANetRule		ps	pw		Case			
		SigU	SigX1	ps	pw		Case			
CAdd	DFatActu.	DFatRule					Case		sigApBu	sigCritBu

3 - Main deck

15	289.56		220.0	10.0	0.0	0.0	ST235	0.550	3.000	100
	268.76	132.59	7.45	24.53	3.89		Wheel-b			
	19.80	5.94		24.53	3.89		Wheel-b			
		176.48	7.37	15.00	8.17		UniCarg-d+			
0.50							c		-6.76	-196.54
16	289.56		220.0	10.0	0.0	0.0	ST235	0.550	3.000	100
	268.76	132.62	7.48	24.53	3.89		Wheel-b			
	19.80	5.94		24.53	3.89		Wheel-b			
		176.11	7.58	15.00	8.61		UniCarg-d+			
0.50							c		-6.94	-196.54

**Local Rule Requirements - Stiffener**

N°	WGActu.	H <sub>1</sub>	E <sub>1</sub>	H <sub>2</sub>	E <sub>2</sub>	Mat	Spac	Span	Bend.Eff.
	WNetActu.	WNetRule	SigX1	ps	pw	Case			
	ANetActu.	ANetRule	SigX1	ps	pw	Case			
		SigU	SigX1	ps	pw	Case			
CAdd	DFatActu.	DFatRule				Case		sigApBu	sigCritBu

4 - Passenger deck

1	35.74	100.0	6.0	0.0	0.0	ST355	0.600	3.000	100
	30.67	15.76	24.65	4.20	5.88	SEA-a1			
	5.00	0.58		4.20	5.88	SEA-a1			
0.50		107.70	31.53	5.00	1.59	AccDeck-b			
						a		-28.80	-154.27
2	35.74	100.0	6.0	0.0	0.0	ST355	0.600	3.000	100
	30.67	15.76	24.65	4.20	5.88	SEA-a1			
	5.00	0.58		4.20	5.88	SEA-a1			
0.50		107.70	31.53	5.00	1.59	AccDeck-b			
						a		-28.80	-154.27
3	35.74	100.0	6.0	0.0	0.0	ST355	0.600	3.000	100
	30.67	15.76	24.65	4.20	5.88	SEA-a1			
	5.00	0.58		4.20	5.88	SEA-a1			
0.50		107.70	31.53	5.00	1.59	AccDeck-b			
						a		-28.80	-154.27
4	35.74	100.0	6.0	0.0	0.0	ST355	0.600	3.000	100
	30.67	15.76	24.65	4.20	5.88	SEA-a1			
	5.00	0.58		4.20	5.88	SEA-a1			
0.50		107.70	31.53	5.00	1.59	AccDeck-b			
						a		-28.80	-154.27
5	2370.53	620.0	8.0	150.0	20.0	ST355	0.600	3.000	100
	2174.26	15.76	24.65	4.20	5.88	SEA-a1			
	43.47	0.58		4.20	5.88	SEA-a1			
0.50		187.34	31.53	5.00	1.59	AccDeck-b			
						a		-28.80	-88.33
6	35.74	100.0	6.0	0.0	0.0	ST355	0.600	3.000	100
	30.67	15.76	24.65	4.20	5.88	SEA-a1			
	5.00	0.58		4.20	5.88	SEA-a1			
0.50		107.70	31.53	5.00	1.59	AccDeck-b			
						a		-28.80	-154.27
7	35.74	100.0	6.0	0.0	0.0	ST355	0.600	3.000	100
	30.67	15.76	24.65	4.20	5.88	SEA-a1			
	5.00	0.58		4.20	5.88	SEA-a1			
0.50		107.70	31.53	5.00	1.59	AccDeck-b			
						a		-28.80	-154.27

**Local Rule Requirements - Stiffener**

N°	WGActu.	H <sub>1</sub>	E <sub>1</sub>	H <sub>2</sub>	E <sub>2</sub>	Mat	Spac	Span	Bend.Eff.
	WNetActu.	WNetRule	SigX1	ps	pw	Case			
	ANetActu.	ANetRule	SigX1	ps	pw	Case			
		SigU	SigX1	ps	pw	Case			
CAdd	DFatActu.	DFatRule				Case		sigApBu	sigCritBu

4 - Passenger deck

8	35.74		100.0	6.0	0.0	0.0	ST355	0.600	3.000	100
	30.67	15.76	24.65	4.20	5.88		SEA-a1			
	5.00	0.58		4.20	5.88		SEA-a1			
0.50		107.70	31.53	5.00	1.59		AccDeck-b			
							a		-28.80	-154.27
9	35.74		100.0	6.0	0.0	0.0	ST355	0.600	3.000	100
	30.67	15.76	24.65	4.20	5.88		SEA-a1			
	5.00	0.58		4.20	5.88		SEA-a1			
0.50		107.70	31.53	5.00	1.59		AccDeck-b			
							a		-28.80	-154.27
10	35.74		100.0	6.0	0.0	0.0	ST355	0.600	3.000	100
	30.67	15.76	24.65	4.20	5.88		SEA-a1			
	5.00	0.58		4.20	5.88		SEA-a1			
0.50		107.70	31.53	5.00	1.59		AccDeck-b			
							a		-28.80	-154.27
11	35.74		100.0	6.0	0.0	0.0	ST355	0.600	3.000	100
	30.67	15.76	24.65	4.20	5.88		SEA-a1			
	5.00	0.58		4.20	5.88		SEA-a1			
0.50		107.70	31.53	5.00	1.59		AccDeck-b			
							a		-28.80	-154.27
12	2370.56		620.0	8.0	150.0	20.0	ST355	0.600	3.000	100
	2174.28	15.76	24.65	4.20	5.88		SEA-a1			
	43.47	0.58		4.20	5.88		SEA-a1			
0.50		187.33	31.53	5.00	1.59		AccDeck-b			
							a		-28.80	-88.33
13	36.78		100.0	6.0	0.0	0.0	ST355	0.600	3.000	100
	31.56	15.99	28.75	4.20	5.88		SEA-a1			
	5.00	0.58		4.20	5.88		SEA-a1			
0.50		95.08	31.47	4.20	5.88		SEA-a1			
							a		-28.75	-124.29
14	36.78		100.0	6.0	0.0	0.0	ST355	0.600	3.000	100
	31.56	15.98	28.69	4.20	5.88		SEA-a1			
	5.00	0.58		4.20	5.88		SEA-a1			
0.50		95.08	31.41	4.20	5.88		SEA-a1			
							a		-28.69	-124.29



**Local Rule Requirements - Stiffener**

N°	WGActu.		H <sub>1</sub>	E <sub>1</sub>	H <sub>2</sub>	E <sub>2</sub>	Mat	Spac	Span	Bend.Eff.
	WNetActu.	WNetRule	SigX1	ps	pw		Case			
	ANetActu.	ANetRule		ps	pw		Case			
		SigU	SigX1	ps	pw		Case			
CAdd	DFatActu.	DFatRule					Case		sigApBu	sigCritBu

4 - Passenger deck

15	36.78		100.0	6.0	0.0	0.0	ST355	0.600	3.000	100
	31.56	15.98	28.64	4.20	5.88		SEA-a1			
	5.00	0.58		4.20	5.88		SEA-a1			
0.50		95.08	31.35	4.20	5.88		SEA-a1			
							a		-28.64	-124.29
16	36.67		100.0	6.0	0.0	0.0	ST355	0.550	3.000	100
	31.48	14.78	28.58	4.20	5.88		SEA-a1			
	5.00	0.54		4.20	5.88		SEA-a1			
0.50		99.28	31.29	4.20	5.88		SEA-a1			
							a		-28.58	-132.64
17	36.67		100.0	6.0	0.0	0.0	ST355	0.550	3.000	100
	31.48	14.78	28.54	4.20	5.88		SEA-a1			
	5.00	0.54		4.20	5.88		SEA-a1			
0.50		99.28	31.24	4.20	5.88		SEA-a1			
							a		-28.54	-132.64

**Local Rule Requirements - Stiffener**

N°	WGActu.		H <sub>1</sub>	E <sub>1</sub>	H <sub>2</sub>	E <sub>2</sub>	Mat	Spac	Span	Bend.Eff.
	WNetActu.	WNetRule	SigX1	ps	pw		Case			
	ANetActu.	ANetRule		ps	pw		Case			
		SigU	SigX1	ps	pw		Case			
CAdd	DFatActu.	DFatRule					Case		sigApBu	sigCritBu

5 - Sun deck

1	35.74		100.0	6.0	0.0	0.0	ST235	0.600	3.000	65
	34.25	0.00								
	6.04	0.00								
0.00		134.67	33.31	0.00	0.00		BULK 5-a2			
							a		-30.42	-145.20
2	35.74		100.0	6.0	0.0	0.0	ST235	0.600	3.000	65
	34.25	0.00								
	6.04	0.00								
0.00		134.67	33.31	0.00	0.00		BULK 5-a2			
							a		-30.42	-145.20
3	35.74		100.0	6.0	0.0	0.0	ST235	0.600	3.000	65
	34.25	0.00								
	6.04	0.00								
0.00		134.67	33.31	0.00	0.00		BULK 5-a2			
							a		-30.42	-145.20
4	35.74		100.0	6.0	0.0	0.0	ST235	0.600	3.000	65
	34.25	0.00								
	6.04	0.00								
0.00		134.67	33.31	0.00	0.00		BULK 5-a2			
							a		-30.42	-145.20
5	797.41		450.0	7.0	100.0	10.0	ST235	0.600	3.000	65
	777.61	0.00								
	31.54	0.00								
0.00		182.10	33.31	0.00	0.00		BULK 5-a2			
							a		-30.42	-120.26
6	35.74		100.0	6.0	0.0	0.0	ST235	0.600	3.000	65
	34.25	0.00								
	6.04	0.00								
0.00		134.67	33.31	0.00	0.00		BULK 5-a2			
							a		-30.42	-145.20
7	35.74		100.0	6.0	0.0	0.0	ST235	0.600	3.000	65
	34.25	0.00								
	6.04	0.00								
0.00		134.67	33.31	0.00	0.00		BULK 5-a2			
							a		-30.42	-145.20

**Local Rule Requirements - Stiffener**

N°	WGActu.	H <sub>1</sub>	E <sub>1</sub>	H <sub>2</sub>	E <sub>2</sub>	Mat	Spac	Span	Bend.Eff.
	WNetActu.	WNetRule	SigX1	ps	pw	Case			
	ANetActu.	ANetRule	SigX1	ps	pw	Case			
		SigU	SigX1	ps	pw	Case			
CAdd	DFatActu.	DFatRule				Case		sigApBu	sigCritBu

5 - Sun deck

8	35.74		100.0	6.0	0.0	0.0	ST235	0.600	3.000	65
	34.25	0.00								
	6.04	0.00								
0.00		134.67	33.31	0.00	0.00	BULK 5-a2				
						a		-30.42	-145.20	
9	35.74		100.0	6.0	0.0	0.0	ST235	0.600	3.000	65
	34.25	0.00								
	6.04	0.00								
0.00		134.67	33.31	0.00	0.00	BULK 5-a2				
						a		-30.42	-145.20	
10	35.74		100.0	6.0	0.0	0.0	ST235	0.600	3.000	65
	34.25	0.00								
	6.04	0.00								
0.00		134.67	33.31	0.00	0.00	BULK 5-a2				
						a		-30.42	-145.20	
11	35.62		100.0	6.0	0.0	0.0	ST235	0.550	3.000	65
	34.11	0.00								
	6.04	0.00								
0.00		142.06	33.31	0.00	0.00	BULK 5-a2				
						a		-30.42	-148.58	
12	35.74		100.0	6.0	0.0	0.0	ST235	0.600	3.000	65
	30.62	17.09	26.01	3.15	4.41	SEA-a1				
	5.00	0.61		3.15	4.41	SEA-a1				
0.50		99.94	33.27	3.15	4.41	SEA-a1				
						a		-30.39	-140.29	
13	35.74		100.0	6.0	0.0	0.0	ST235	0.600	3.000	65
	30.62	17.09	25.98	3.15	4.41	SEA-a1				
	5.00	0.61		3.15	4.41	SEA-a1				
0.50		99.94	33.23	3.15	4.41	SEA-a1				
						a		-30.35	-140.29	
14	35.74		100.0	6.0	0.0	0.0	ST235	0.600	3.000	65
	30.62	17.09	25.95	3.15	4.41	SEA-a1				
	5.00	0.61		3.15	4.41	SEA-a1				
0.50		99.94	33.19	3.15	4.41	SEA-a1				
						a		-30.32	-140.29	

**Local Rule Requirements - Stiffener**

N°	WGActu.		H <sub>1</sub>	E <sub>1</sub>	H <sub>2</sub>	E <sub>2</sub>	Mat	Spac	Span	Bend.Eff.
	WNetActu.	WNetRule	SigX1	ps	pw		Case			
	ANetActu.	ANetRule		ps	pw		Case			
		SigU	SigX1	ps	pw		Case			
CAdd	DFatActu.	DFatRule					Case		sigApBu	sigCritBu

5 - Sun deck

15	35.61		100.0	6.0	0.0	0.0	ST235	0.550	3.000	65
	30.52	15.81	25.92	3.15	4.41		SEA-a1			
	5.00	0.56		3.15	4.41		SEA-a1			
0.50		106.38	33.15	3.15	4.41		SEA-a1			
							a		-30.28	-144.16
16	35.61		100.0	6.0	0.0	0.0	ST235	0.550	3.000	65
	30.52	15.81	25.89	3.15	4.41		SEA-a1			
	5.00	0.56		3.15	4.41		SEA-a1			
0.50		106.38	33.12	3.15	4.41		SEA-a1			
							a		-30.25	-144.16

**Local Rule Requirements - Stiffener**

N°	WGActu.	H <sub>1</sub>	E <sub>1</sub>	H <sub>2</sub>	E <sub>2</sub>	Mat	Spac	Span	Bend.Eff.
	WNetActu.	WNetRule	SigX1	ps	pw	Case			
	ANetActu.	ANetRule	SigX1	ps	pw	Case			
		SigU	SigX1	ps	pw	Case			
CAdd	DFatActu.	DFatRule				Case		sigApBu	sigCritBu

6 - Wheelhouse deck

1	35.74	100.0	6.0	0.0	0.0	ST235	0.600	3.000	10
	30.67	0.00							
	5.00	0.00							
0.50		136.59	5.41	0.00	0.00	FLOOD 7-Floc			
						a		-7.06	-138.36
2	35.74	100.0	6.0	0.0	0.0	ST235	0.600	3.000	10
	30.67	0.00							
	5.00	0.00							
0.50		136.59	5.41	0.00	0.00	FLOOD 7-Floc			
						a		-7.06	-138.36
3	35.74	100.0	6.0	0.0	0.0	ST235	0.600	3.000	10
	30.67	0.00							
	5.00	0.00							
0.50		136.59	5.41	0.00	0.00	FLOOD 7-Floc			
						a		-7.06	-138.36
4	35.74	100.0	6.0	0.0	0.0	ST235	0.600	3.000	10
	30.67	0.00							
	5.00	0.00							
0.50		136.59	5.41	0.00	0.00	FLOOD 7-Floc			
						a		-7.06	-138.36
5	35.74	100.0	6.0	0.0	0.0	ST235	0.600	3.000	10
	30.67	0.00							
	5.00	0.00							
0.50		136.59	5.41	0.00	0.00	FLOOD 7-Floc			
						a		-7.06	-138.36
6	35.74	100.0	6.0	0.0	0.0	ST235	0.600	3.000	10
	30.67	0.00							
	5.00	0.00							
0.50		136.59	5.41	0.00	0.00	FLOOD 7-Floc			
						a		-7.06	-138.36
7	35.74	100.0	6.0	0.0	0.0	ST235	0.600	3.000	10
	30.67	0.00							
	5.00	0.00							
0.50		136.59	5.41	0.00	0.00	FLOOD 7-Floc			
						a		-7.06	-138.36

**Local Rule Requirements - Stiffener**

N°	WGActu.	H <sub>1</sub>	E <sub>1</sub>	H <sub>2</sub>	E <sub>2</sub>	Mat	Spac	Span	Bend.Eff.
	WNetActu.	WNetRule	SigX1	ps	pw	Case			
	ANetActu.	ANetRule	SigX1	ps	pw	Case			
		SigU	SigX1	ps	pw	Case			
CAdd	DFatActu.	DFatRule				Case		sigApBu	sigCritBu

6 - Wheelhouse deck

8	35.74		100.0	6.0	0.0	0.0	ST235	0.600	3.000	10
	30.67	0.00								
	5.00	0.00								
0.50		136.59	5.41	0.00	0.00	FLOOD 7-Floc			-7.06	-138.36
						a				
9	35.74		100.0	6.0	0.0	0.0	ST235	0.600	3.000	10
	30.67	0.00								
	5.00	0.00								
0.50		136.59	5.41	0.00	0.00	FLOOD 7-Floc			-7.06	-138.36
						a				
10	35.74		100.0	6.0	0.0	0.0	ST235	0.600	3.000	10
	30.67	0.00								
	5.00	0.00								
0.50		136.59	5.41	0.00	0.00	FLOOD 7-Floc			-7.06	-138.36
						a				
11	35.62		100.0	6.0	0.0	0.0	ST235	0.550	3.000	10
	30.57	0.00								
	5.00	0.00								
0.50		149.48	5.41	0.00	0.00	FLOOD 6-Floc			-7.06	-142.40
						a				
12	35.74		100.0	6.0	0.0	0.0	ST235	0.600	3.000	10
	30.66	9.25	6.04	1.87	2.62	SEA-a1				
	5.00	0.36		1.87	2.62	SEA-a1				
0.50		116.73	7.72	1.87	2.62	SEA-a1			-7.05	-138.36
						a				
13	35.74		100.0	6.0	0.0	0.0	ST235	0.600	3.000	10
	30.66	9.25	6.03	1.87	2.62	SEA-a1				
	5.00	0.36		1.87	2.62	SEA-a1				
0.50		116.73	7.72	1.87	2.62	SEA-a1			-7.05	-138.36
						a				
14	35.74		100.0	6.0	0.0	0.0	ST235	0.600	3.000	10
	30.66	9.25	6.03	1.87	2.62	SEA-a1				
	5.00	0.36		1.87	2.62	SEA-a1				
0.50		116.73	7.71	1.87	2.62	SEA-a1			-7.04	-138.36
						a				

**Local Rule Requirements - Stiffener**

N°	WGActu.		H <sub>1</sub>	E <sub>1</sub>	H <sub>2</sub>	E <sub>2</sub>	Mat	Spac	Span	Bend.Eff.
	WNetActu.	WNetRule	SigX1	ps	pw		Case			
	ANetActu.	ANetRule		ps	pw		Case			
		SigU	SigX1	ps	pw		Case			
CAdd	DFatActu.	DFatRule					Case		sigApBu	sigCritBu

6 - Wheelhouse deck

15	35.74		100.0	6.0	0.0	0.0	ST235	0.600	3.000	10
	30.66	9.25	6.02	1.87	2.62		SEA-a1			
	5.00	0.36		1.87	2.62		SEA-a1			
0.50		116.73	7.70	1.87	2.62		SEA-a1			
							a		-7.04	-138.36
16	35.61		100.0	6.0	0.0	0.0	ST235	0.550	3.000	10
	30.56	8.56	6.02	1.87	2.62		SEA-a1			
	5.00	0.33		1.87	2.62		SEA-a1			
0.50		122.31	7.70	1.87	2.62		SEA-a1			
							a		-7.03	-142.38

**Local Rule Requirements - Stiffener**

N°	WGActu.		H <sub>1</sub>	E <sub>1</sub>	H <sub>2</sub>	E <sub>2</sub>	Mat	Spac	Span	Bend.Eff.
	WNetActu.	WNetRule	SigX1	ps	pw		Case			
	ANetActu.	ANetRule		ps	pw		Case			
		SigU	SigX1	ps	pw		Case			
CAdd	DFatActu.	DFatRule					Case		sigApBu	sigCritBu

7 - Inner Side 6000

1	61.72		120.0	8.0	0.0	0.0	ST235	0.700	3.000	100
	55.86	*	61.54	14.69	20.61	7.06	FLOOD 1-Flood			
	8.40		2.30		20.61	7.06	FLOOD 1-Flood			
			60.38	13.84	20.61	7.06	FLOOD 1-Flood			
0.50							a		-17.72	-159.67
2	57.19		120.0	7.0	0.0	0.0	ST235	0.740	3.000	100
	51.27		47.63	11.50	13.57	7.06	FLOOD 1-Flood			
	7.20		1.81		13.57	7.06	FLOOD 1-Flood			
			67.65	10.84	13.57	7.06	FLOOD 1-Flood			
0.50							a		-13.87	-154.70
3	139.72		150.0	20.0	0.0	0.0	ST235	0.697	3.000	100
	130.63		30.67	7.94	7.06	7.06	FLOOD 1-Flood			
	28.50		1.18		7.06	7.06	FLOOD 1-Flood			
			149.67	7.48	7.06	7.06	FLOOD 2-Flood			
0.50							a		-9.58	-184.43



**Local Rule Requirements - Stiffener**

N°	WActu.		H <sub>1</sub>	E <sub>1</sub>	H <sub>2</sub>	E <sub>2</sub>	Mat	Spac	Span	Bend.Eff.
	WNetActu.	WNetRule	SigX1	ps	pw		Case			
	ANetActu.	ANetRule		ps	pw		Case			
		SigU	SigX1	ps	pw		Case			
CAdd	DFatActu.	DFatRule					Case		sigApBu	sigCritBu

8 - Superstructure side

**Local Rule Requirements - Stiffener**

N°	WGActu.	H <sub>1</sub>	E <sub>1</sub>	H <sub>2</sub>	E <sub>2</sub>	Mat	Spac	Span	Bend.Eff.
	WNetActu.	WNetRule	SigX1	ps	pw	Case			
	ANetActu.	ANetRule		ps	pw	Case			
		SigU	SigX1	ps	pw	Case			
CAdd	DFatActu.	DFatRule				Case		sigApBu	sigCritBu

9 - Superstructure top

1	35.74		100.0	6.0	0.0	0.0	ST235	0.600	3.000	30
	23.40	0.00								
	2.97	0.00								
1.50		134.04	21.28	0.00	0.00		BULK 5-a2			
							a		-19.44	-125.90
2	35.74		100.0	6.0	0.0	0.0	ST235	0.600	3.000	30
	23.40	0.00								
	2.97	0.00								
1.50		134.04	21.28	0.00	0.00		BULK 5-a2			
							a		-19.44	-125.90
3	35.74		100.0	6.0	0.0	0.0	ST235	0.600	3.000	30
	23.40	0.00								
	2.97	0.00								
1.50		134.04	21.27	0.00	0.00		BULK 5-a2			
							a		-19.43	-125.89
4	35.74		100.0	6.0	0.0	0.0	ST235	0.600	3.000	30
	23.40	0.00								
	2.97	0.00								
1.50		134.04	21.26	0.00	0.00		BULK 5-a2			
							a		-19.42	-125.89
5	797.41		450.0	7.0	100.0	10.0	ST235	0.600	3.000	30
	520.32	0.00								
	18.08	0.00								
1.50		218.09	21.25	0.00	0.00		BULK 5-a2			
							a		-19.41	-54.42
6	35.74		100.0	6.0	0.0	0.0	ST235	0.600	3.000	30
	23.40	0.00								
	2.97	0.00								
1.50		134.04	21.24	0.00	0.00		BULK 5-a2			
							a		-19.40	-125.89
7	35.74		100.0	6.0	0.0	0.0	ST235	0.600	3.000	30
	23.40	0.00								
	2.97	0.00								
1.50		134.04	21.23	0.00	0.00		BULK 5-a2			
							a		-19.39	-125.89

**Local Rule Requirements - Stiffener**

N°	WGActu.		H <sub>1</sub>	E <sub>1</sub>	H <sub>2</sub>	E <sub>2</sub>	Mat	Spac	Span	Bend.Eff.
	WNetActu.	WNetRule	SigX1	ps	pw		Case			
	ANetActu.	ANetRule		ps	pw		Case			
		SigU	SigX1	ps	pw		Case			
CAdd	DFatActu.	DFatRule					Case		sigApBu	sigCritBu

9 - Superstructure top

8	35.74		100.0	6.0	0.0	0.0	ST235	0.600	3.000	30
	23.40	0.00								
	2.97	0.00								
1.50		134.04	21.22	0.00	0.00		BULK 5-a2			
							a		-19.38	-125.89
9	35.74		100.0	6.0	0.0	0.0	ST235	0.600	3.000	30
	23.40	0.00								
	2.97	0.00								
1.50		134.04	21.21	0.00	0.00		BULK 5-a2			
							a		-19.37	-125.89
10	35.74		100.0	6.0	0.0	0.0	ST235	0.600	3.000	30
	23.40	0.00								
	2.97	0.00								
1.50		134.04	21.20	0.00	0.00		BULK 5-a2			
							a		-19.36	-125.89
11	35.61		100.0	6.0	0.0	0.0	ST235	0.550	3.000	30
	23.35	0.00								
	2.97	0.00								
1.50		138.74	21.19	0.00	0.00		BULK 5-a2			
							a		-19.35	-131.17

**Local Rule Requirements - Stiffener**

N°	WGActu.		H <sub>1</sub>	E <sub>1</sub>	H <sub>2</sub>	E <sub>2</sub>	Mat	Spac	Span	Bend.Eff.
	WNetActu.	WNetRule	SigX1	ps	pw		Case			
	ANetActu.	ANetRule		ps	pw		Case			
		SigU	SigX1	ps	pw		Case			
CAdd	DFatActu.	DFatRule					Case		sigApBu	sigCritBu

10 - Sun deck side

1	63.77		150.0	10.0	0.0	0.0	ST235	0.225	3.000	0
	56.42	0.00								
	13.50	0.00								
0.50		0.00	0.00	0.00	0.00		-			
							a		0.00	-181.31

**Local Rule Requirements - Stiffener**

N°	WGActu.		H <sub>1</sub>	E <sub>1</sub>	H <sub>2</sub>	E <sub>2</sub>	Mat	Spac	Span	Bend.Eff.
	WNetActu.	WNetRule	SigX1	ps	pw		Case			
	ANetActu.	ANetRule		ps	pw		Case			
		SigU	SigX1	ps	pw		Case			
CAdd	DFatActu.	DFatRule					Case		sigApBu	sigCritBu

11 - Wheelhouse deck side

1	30.47		100.0	10.0	0.0	0.0	ST235	0.225	3.000	0
	26.91	0.00								
	9.00	0.00								
0.50		0.00	0.00	0.00	0.00		-			
							a		0.00	-157.67

**Local Rule Requirements - Stiffener**

N°	WActu.		H <sub>1</sub>	E <sub>1</sub>	H <sub>2</sub>	E <sub>2</sub>	Mat	Spac	Span	Bend.Eff.
	WNetActu.	WNetRule	SigX1	ps	pw		Case			
	ANetActu.	ANetRule		ps	pw		Case			
		SigU	SigX1	ps	pw		Case			
CAdd	DFatActu.	DFatRule					Case		sigApBu	sigCritBu

12 - Side girder 3000

**Local Rule Requirements - Stiffener**

N°	WGActu.		H <sub>1</sub>	E <sub>1</sub>	H <sub>2</sub>	E <sub>2</sub>	Mat	Spac	Span	Bend.Eff.
	WNetActu.	WNetRule	SigX1	ps	pw		Case			
	ANetActu.	ANetRule		ps	pw		Case			
		SigU	SigX1	ps	pw		Case			
CAdd	DFatActu.	DFatRule					Case		sigApBu	sigCritBu

13 - Centar girder

**Local Rule Requirements - Stiffener**

N°	WGActu.	H <sub>1</sub>	E <sub>1</sub>	H <sub>2</sub>	E <sub>2</sub>	Mat	Spac	Span	Bend.Eff.
	WNetActu.	WNetRule	SigX1	ps	pw	Case			
	ANetActu.	ANetRule		ps	pw	Case			
		SigU	SigX1	ps	pw	Case			
CAdd	DFatActu.	DFatRule				Case		sigApBu	sigCritBu

14 - Wheelhouse top

1	723.95	350.0	7.0	150.0	10.0	ST235	0.600	3.000	0
	711.57	0.00							
	24.54	0.00							
0.00		0.00	0.00	0.00	0.00	-		0.00	-169.90
						a			
2	35.74	100.0	6.0	0.0	0.0	ST235	0.600	3.000	0
	34.30	0.00							
	6.03	0.00							
0.00		0.00	0.00	0.00	0.00	-		0.00	-143.51
						a			
3	35.74	100.0	6.0	0.0	0.0	ST235	0.600	3.000	0
	34.30	0.00							
	6.03	0.00							
0.00		0.00	0.00	0.00	0.00	-		0.00	-143.51
						a			
4	35.74	100.0	6.0	0.0	0.0	ST235	0.600	3.000	0
	34.30	0.00							
	6.03	0.00							
0.00		0.00	0.00	0.00	0.00	-		0.00	-143.51
						a			
5	35.74	100.0	6.0	0.0	0.0	ST235	0.600	3.000	0
	34.30	0.00							
	6.03	0.00							
0.00		0.00	0.00	0.00	0.00	-		0.00	-143.51
						a			
6	35.74	100.0	6.0	0.0	0.0	ST235	0.600	3.000	0
	34.30	0.00							
	6.03	0.00							
0.00		0.00	0.00	0.00	0.00	-		0.00	-143.51
						a			
7	35.74	100.0	6.0	0.0	0.0	ST235	0.600	3.000	0
	34.30	0.00							
	6.03	0.00							
0.00		0.00	0.00	0.00	0.00	-		0.00	-143.51
						a			



**Local Rule Requirements - Stiffener**

N°	WGActu.		H <sub>1</sub>	E <sub>1</sub>	H <sub>2</sub>	E <sub>2</sub>	Mat	Spac	Span	Bend.Eff.
	WNetActu.	WNetRule	SigX1	ps	pw		Case			
	ANetActu.	ANetRule		ps	pw		Case			
		SigU	SigX1	ps	pw		Case			
CAdd	DFatActu.	DFatRule					Case		sigApBu	sigCritBu

14 - Wheelhouse top

8	35.74		100.0	6.0	0.0	0.0	ST235	0.600	3.000	0
	34.30	0.00								
	6.03	0.00								
0.00		0.00	0.00	0.00	0.00		-		0.00	-143.51
							a			
9	35.74		100.0	6.0	0.0	0.0	ST235	0.600	3.000	0
	34.30	0.00								
	6.03	0.00								
0.00		0.00	0.00	0.00	0.00		-		0.00	-143.51
							a			
10	35.61		100.0	6.0	0.0	0.0	ST235	0.550	3.000	0
	34.17	0.00								
	6.03	0.00								
0.00		0.00	0.00	0.00	0.00		-		0.00	-147.01
							a			
11	27.86		100.0	10.0	0.0	0.0	ST235	0.120	3.000	0
	24.55	0.00								
	9.00	0.00								
0.50		0.00	0.00	0.00	0.00		-		0.00	-162.58
							a			

**Local Rule Requirements - Stiffener**

N°	WGActu.		H <sub>1</sub>	E <sub>1</sub>	H <sub>2</sub>	E <sub>2</sub>	Mat	Spac	Span	Bend.Eff.
	WNetActu.	WNetRule	SigX1	ps	pw		Case			
	ANetActu.	ANetRule		ps	pw		Case			
		SigU	SigX1	ps	pw		Case			
CAdd	DFatActu.	DFatRule					Case		sigApBu	sigCritBu

15 - Wheelhouse side

1	73.28		150.0	10.0	0.0	0.0	ST235	1.234	3.000	0
	72.95	0.00								
	14.77	0.00								
0.00		0.00	0.00	0.00	0.00		-		0.00	-165.64
							a			
2	73.17		150.0	10.0	0.0	0.0	ST235	1.195	3.000	0
	72.84	0.00								
	14.77	0.00								
0.00		0.00	0.00	0.00	0.00		-		0.00	-166.58
							a			

**Local Rule Requirements - Stiffener**

N°	WGActu.		H <sub>1</sub>	E <sub>1</sub>	H <sub>2</sub>	E <sub>2</sub>	Mat	Spac	Span	Bend.Eff.
	WNetActu.	WNetRule	SigX1	ps	pw		Case			
	ANetActu.	ANetRule		ps	pw		Case			
		SigU	SigX1	ps	pw		Case			
CAdd	DFatActu.	DFatRule					Case		sigApBu	sigCritBu

16 - Outer shell<sub>s</sub>plitted

1	36.97		100.0	6.0	0.0	0.0	ST235	0.700	3.000	100
	31.71	25.45	4.88	0.00	10.11		SEA-c+			
	5.00	1.00		0.00	10.11		SEA-a1			
0.50		84.97	5.41	0.00	10.11		SEA-c+			
							c		-4.88	-110.09
2	36.47		100.0	6.0	0.0	0.0	ST235	0.700	3.000	100
	31.28	25.37	4.18	0.00	10.11		SEA-c+			
	5.00	1.00		0.00	10.11		SEA-a1			
0.50		87.81	4.68	0.00	10.11		SEA-c+			
							c		-4.18	-120.01
3	36.47		100.0	6.0	0.0	0.0	ST235	0.700	3.000	100
	31.28	25.67	6.72	0.00	10.11		SEA-c+			
	5.00	1.00		0.00	10.11		SEA-a1			
0.50		87.81	7.39	0.00	10.11		SEA-c+			
							c		-6.72	-120.01
4	36.47		100.0	6.0	0.0	0.0	ST235	0.700	3.000	100
	31.28	19.58	10.48	0.00	7.58		SEA-a1			
	5.00	0.75		0.00	7.58		SEA-a1			
0.50		94.11	11.47	0.00	7.58		SEA-a1			
							a		-10.48	-120.01
5	36.47		100.0	6.0	0.0	0.0	ST235	0.700	3.000	100
	31.28	20.00	14.98	0.00	7.58		SEA-a1			
	5.00	0.75		0.00	7.58		SEA-a1			
0.50		94.11	16.40	0.00	7.58		SEA-a1			
							a		-14.98	-120.01
6	36.93		100.0	6.0	0.0	0.0	ST235	0.675	3.000	100
	31.68	19.80	19.48	0.00	7.58		SEA-a1			
	5.00	0.72		0.00	7.58		SEA-a1			
0.50		91.98	21.32	0.00	7.58		SEA-a1			
							a		-19.48	-112.87
7	141.14		150.0	20.0	0.0	0.0	ST235	0.700	3.000	100
	132.13	15.58	23.66	0.00	5.66		SEA-a1			
	28.50	0.56		0.00	5.66		SEA-a1			
0.50		165.68	25.90	0.00	5.66		SEA-a1			
							a		-23.66	-183.81