

Navoz

Donadić, Dorian

Supplement / Prilog

Publication year / Godina izdavanja: **2022**

Permanent link / Trajna poveznica: <https://urn.nsk.hr/urn:nbn:hr:190:320627>

Rights / Prava: [Attribution 4.0 International](#)/[Imenovanje 4.0 međunarodna](#)

Download date / Datum preuzimanja: **2025-01-27**



Repository / Repozitorij:

[Repository of the University of Rijeka, Faculty of Engineering](#)



NAVOZ

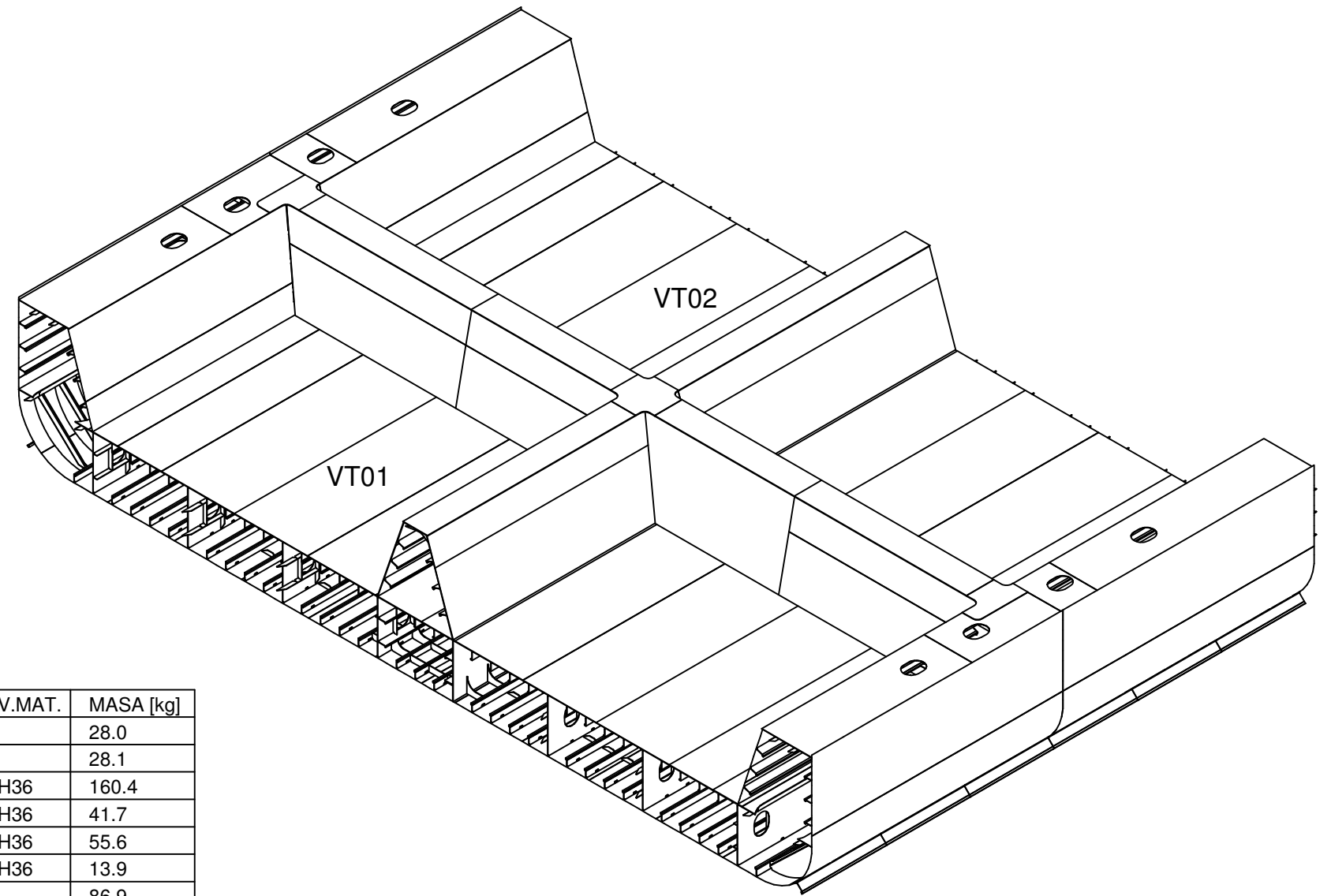

OZNAKA	RAD.MARKA	NAZIV	BROJ	DIMENZIJE	KV.MAT.	MASA [kg]
CT3410-Z5300B/S2*	659	profil	4	FB10: 150x10.0 L=696.50	A	28.0
CT3410-Z5300B/S2*	554	profil	4	FB10: 150x10.0 L=698.00	A	28.1
CT3410-*	190	lim	122	13.00	AH36	160.4
CT3410-Y*	553	profil	6	FB10: 150x10.0 L=697.00	AH36	41.7
CT3410-Y*	553	profil	8	FB10: 150x10.0 L=696.00	AH36	55.6
CT3410-Y5390A/S37*	552	profil	2	FB10: 150x10.0 L=697.00	AH36	13.9
CT3410-X122*	809	bracket pl	23	12.0	A	86.9
CT3410-X1*	810	bracket pl	21	12.0	A	74.3
CT3410-*	823	bracket pl	47	12.0	A	165.1
CT3410-X110D-1*	825	bracket pl	6	12.0	A	21.9
CT3410-Z2150/S*	551	profil	2	FB10: 160x12.0 L=596.00	A	14.6
CT3410-Z2150/S*	550	profil	2	FB10: 160x12.0 L=596.00	A	14.6
CT3410-Z2150/S*	551	profil	2	FB10: 160x12.0 L=598.00	A	14.6
CT3410-Z2150/S8*	550	profil	2	FB10: 160x12.0 L=598.00	A	14.6
CT3410-YKOSO19-1SP	68	lim	1	17.50	AH36	61.1
VT01		sklop	1			251691.7
VT02		sklop	1			195768.5
MP001_KALJL		sklop	1			87.1
MP001_KALJD		sklop	1			87.1
	POZ.1	ČEP	2	1320785		
	POZ.1	PRSTEN	2	1317679		
	POZ.1	BRTVA	2	1317733		

GRADNJA: 722, 723	NACRT BROJ: 4-341-010	LIST: 1	TEZINA: 448429.796
		LISTOVA: 1	TEZISTE X: FR110+335.0
SKLOP: 3410			TEZISTE Y: -1
DATUM:			TEZISTE Z: 1927