

# Panel

---

**Donadić, Dorian**

**Supplement / Prilog**

*Publication year / Godina izdavanja:* **2022**

*Permanent link / Trajna poveznica:* <https://urn.nsk.hr/urn:nbn:hr:190:098406>

*Rights / Prava:* [Attribution 4.0 International](#)/[Imenovanje 4.0 međunarodna](#)

*Download date / Datum preuzimanja:* **2025-02-04**



*Repository / Repozitorij:*

[Repository of the University of Rijeka, Faculty of Engineering](#)



# P120

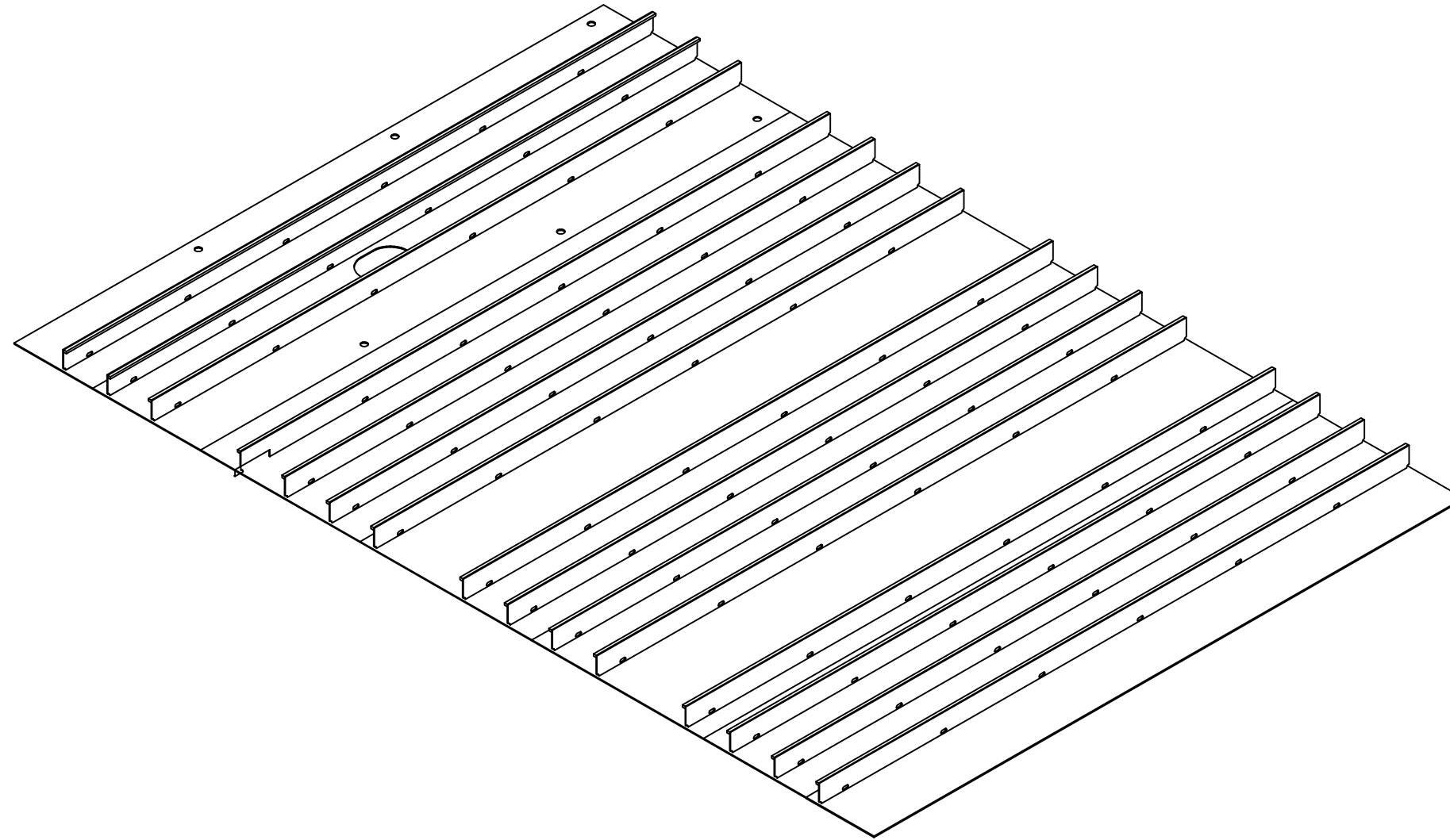

OZNAKA	RAD.MARKA	NAZIV	BROJ	DIMENZIJE	KV.MAT.	MASA [kg]
CT3410-Z2150/S70S	673	profil	1	HP20: 320x13.0 L=10249.99	AH36	464.9
CT3410-Z2150/S*	667	profil	12	HP20: 320x13.0 L=10249.98	AH36	5578.5
CT3410-Z2150/S57P	669	profil	1	HP20: 320x13.0 L=10249.98	AH36	459.1
CT3410-Z2150/S3S	673	profil	1	HP20: 320x13.0 L=10249.98	AH36	464.9
CT3410-Z2150-26SP	253	lim	1	20.50	AH36	1959.1
CT3410-Z2150-19SP	250	lim	1	15.50	AH36	2241.5
CT3410-Z2150-18SP	247	lim	1	15.00	AH36	3629.6
CT3410-Z2150-17SP	245	lim	1	15.00	AH36	3629.6
CT3410-Z2150-16SP	242	lim	1	15.00	AH36	3372.9
CT3410-Z2150-15SP	237	lim	1	15.00	AH36Z25	2228.3
CT3410-Z2150-14SP	238	lim	1	15.00	AH36Z25	1662.9

GRADNJA: 722, 723	NACRT BROJ: 4-341-010	LIST: 3	TEZINA: 25691.262
SKLOP: <b>3410-VT02-KP12-P120</b>		LISTOVA: 8	TEZISTE X: FR116+317.0
DATUM:			TEZISTE Y: 5997
			TEZISTE Z: 2102