

# Midship section

---

**Penava, Davor**

**Supplement / Prilog**

*Publication year / Godina izdavanja:* **2022**

*Permanent link / Trajna poveznica:* <https://urn.nsk.hr/urn:nbn:hr:190:464200>

*Rights / Prava:* [Attribution-NonCommercial-NoDerivatives 4.0 International/Imenovanje-Nekomercijalno-Bez prerada 4.0 međunarodna](#)

*Download date / Datum preuzimanja:* **2025-04-05**



*Repository / Repozitorij:*

[Repository of the University of Rijeka, Faculty of Engineering](#)



### WEB FRAME

Spacing 2320 mm  
 Plate 9mm U.N.O.  
 Deck girders W 550x5 / FL 200x5 U.N.O.  
 Deck beams W 550x5 / FL 200x5 U.N.O.  
 Longitudinal stiffener HP 180x9 U.N.O.  
 Tripping bracket FB 100x10 U.N.O.  
 Opening 600x400 U.N.O.

### ORDINARY FRAME

Spacing 580 mm  
 Plate 9mm U.N.O.  
 Deck girders W 550x5 / FL 200x5 U.N.O.  
 Deck beams W 550x5 / FL 200x5 U.N.O.  
 Longitudinal stiffener HP 180x9 U.N.O.  
 Tripping bracket FB 100x10 U.N.O.  
 Opening 600x400 U.N.O.

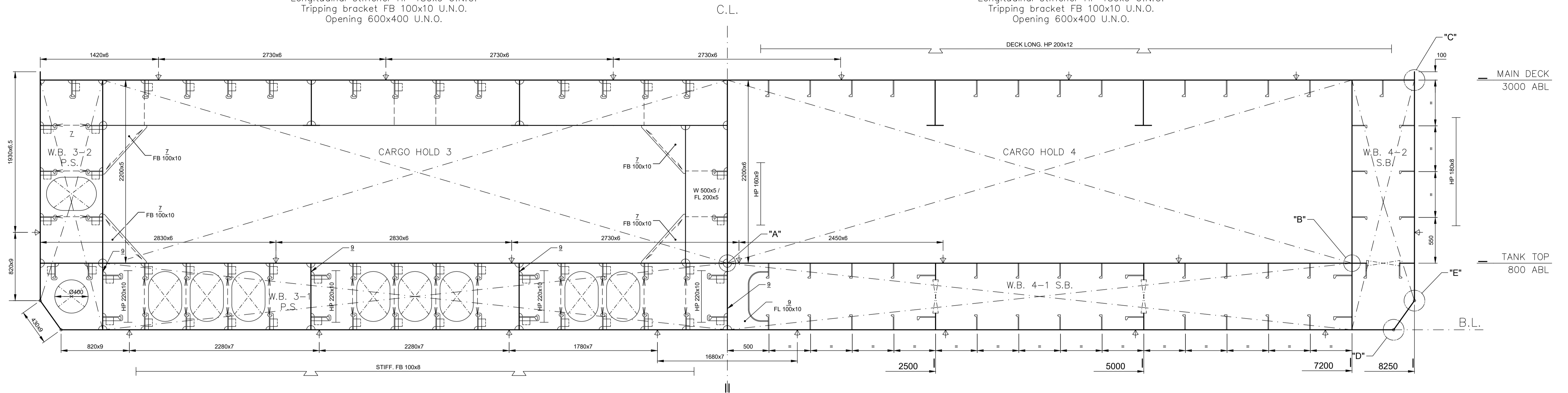

#### DETAIL "A"

SCALE 1:5  
 Full penetration weld

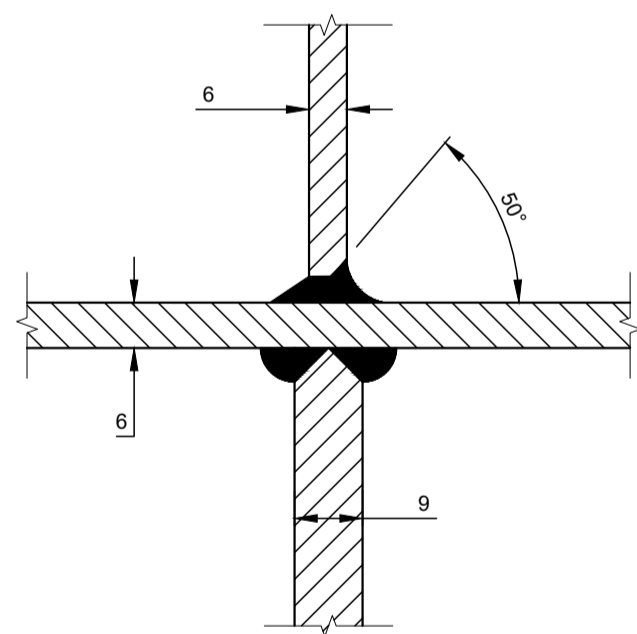

#### DETAIL "B"

SCALE 1:1  
 Full penetration weld

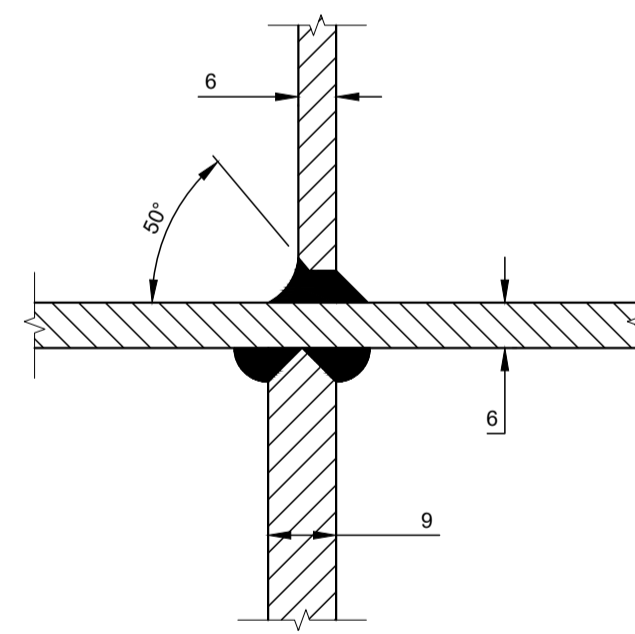

#### DETAIL "C"

SCALE 1:1  
 Full penetration weld

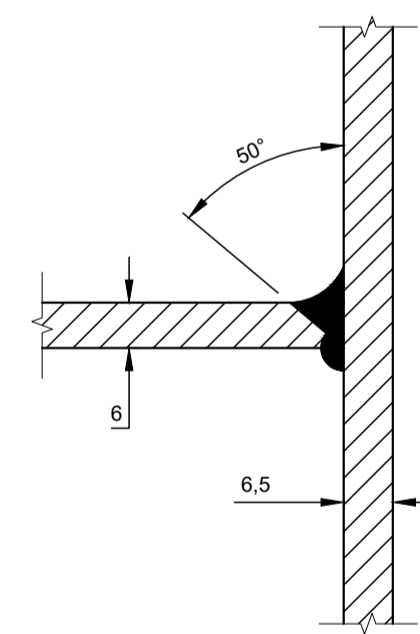

#### DETAIL "D"

SCALE 1:1  
 Full penetration weld

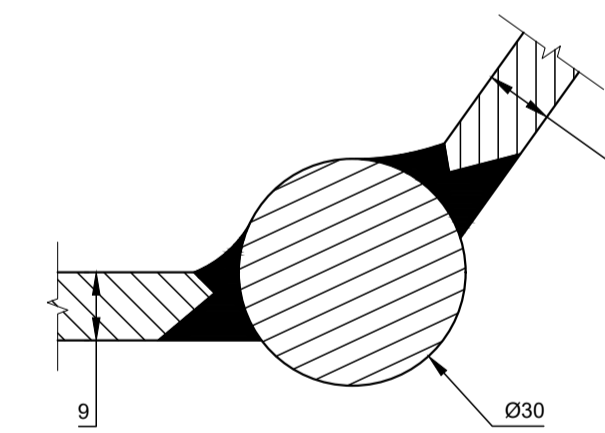

#### DETAIL "E"

SCALE 1:1  
 Full penetration weld

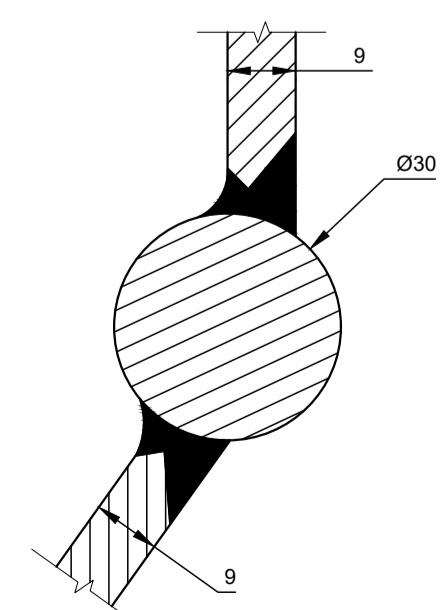

### DAMEN BUNKER BARGE 6316

#### LLOYD'S CLASS

Transport of liquid cargoes Harbours, Inland waters  
 +AT IWW, Oil Barge, Carriage of Oils with a FP exceeding 60°C

#### MAIN CHARACTERISTICS:

LENGHT O.A.	63.10 m
BEAM MLD	16.50 m
DEPTH MLD	3.00 m
DRAUGHT BALLAST	1.25 m
AIR DRAFT	2.75 m
DRAUGHT DESIGN	1.80 m
DEADWEIGHT	1450.00 ton

#### CAPACITIES

CARGO TANKS VOLUME	1450 m <sup>3</sup>
BALLAST TANKS VOLUME	840 m <sup>3</sup>

#### DESIGN CONDITIONS

SEA WATER TEMPERATURE	0°C to + 35°C
OUTSIDE AIR TEMPERATURE	5°C to + 45°C

ISSUED	DESCRIPTION OF MODIFICATION	DATE	MODIFIED	APPROVED
TITLE: MIDSHIP SECTION				
APPROVALS				DATE
SIGNATURE				DATE
DRAWN	Davor Penava	15/9/2022		
CHECKED	Davor Penava	15/9/2022		
ISSUED	Davor Penava	15/9/2022		
DWG. NO. T-MS-001		SIZE A1	ISSUE: 0	
SCALE: 1:25		SHEET: 1/2		

