

# Preliminarni projekt rekreacijskog brzog motornog plovila s dužinom od 10-ak metara

---

**Kašikić, Ivan**

**Master's thesis / Diplomski rad**

**2023**

*Degree Grantor / Ustanova koja je dodijelila akademski / stručni stupanj:* **University of Rijeka, Faculty of Engineering / Sveučilište u Rijeci, Tehnički fakultet**

*Permanent link / Trajna poveznica:* <https://um.nsk.hr/um:nbn:hr:190:163754>

*Rights / Prava:* [Attribution 4.0 International](#)/[Imenovanje 4.0 međunarodna](#)

*Download date / Datum preuzimanja:* **2025-02-20**



*Repository / Repozitorij:*

[Repository of the University of Rijeka, Faculty of Engineering](#)



SVEUČILIŠTE U RIJECI  
TEHNIČKI FAKULTET

Sveučilišni diplomski studij brodogradnje

Diplomski rad

**PRELIMINARNI PROJEKT REKREACIJSKOG BRZOG  
MOTORNOG PLOVILA S DUŽINOM OD 10-AK METARA**

Rijeka, rujan 2023

Ivan Kašikić

0069065617

SVEUČILIŠTE U RIJECI  
TEHNIČKI FAKULTET

Sveučilišni diplomski studij brodogradnje

Diplomski rad

**PRELIMINARNI PROJEKT REKREACIJSKOG BRZOG  
MOTORNOG PLOVILA S DUŽINOM OD 10-AK METARA**

Mentor: Prof. dr. sc. Roko Dejhalla

Rijeka, rujan 2023

Ivan Kašikić

0069065617

Rijeka, 18. ožujka 2022.

Zavod: **Zavod za brodogradnju i inženjerstvo morske tehnologije**  
Predmet: **Diplomski rad**  
Polje: **2.02 Brodogradnja**

## ZADATAK ZA DIPLOMSKI RAD

Pristupnik: **Ivan Kašikić (0069065617)**  
Studij: **Diplomski sveučilišni studij brodogradnje**  
Modul: **Projektiranje i konstrukcija plovni objekata**

Zadatak: **PRELIMINARNI PROJEKT REKREACIJSKOG BRZOG MOTORNOG PLOVILA  
S DUŽINOM OD 10-AK METARA**

### Opis zadatka:

Razraditi projektni zahtjev za projekt brzog motornog rekreacijskog plovila dužine 10-ak metara.  
Prema projektnom zahtjevu izraditi preliminarni projekt plovila s pripadajućim proračunima, crtežom linija, općim planom i tehničkim opisom.  
Za propulzijski sustav analizirati izvedbu s brodskim vijcima te vodomlaznim propulzorima.  
Preliminarni projekt uskladiti s primjenjivim tehničkim zahtjevima iz ISO normi.  
Rad mora biti napisan prema Uputama za pisanje diplomskih / završnih radova koje su objavljene na mrežnim stranicama studija.



Zadatak uručen pristupniku: 21. ožujka 2022.  
Rok za predaju rada: 7. srpnja 2022.

Mentor:



Prof. dr. sc. Roko Dejhalla

Predsjednik povjerenstva za  
diplomski ispit:



Prof. dr. sc. Albert Zamarin

## **IZJAVA**

Sukladno članku 7. Pravilnika o diplomskom radu, diplomskom ispitu i završetku diplomskih studija na Tehničkom fakultetu Sveučilišta u Rijeci iz ožujka 2023., izjavljujem da sam samostalno radio diplomski rad pod nazivom: „PRELIMINARNI PROJEKT REKREACIJSKOG BRZOG MOTORNOG PLOVILA S DUŽINOM OD 10-AK METARA“ uz konzultacije sa mentorom.

---

Ovim putem se želim zahvaliti svojim roditeljima kao i sestri koji su mi pružali moralnu i financijsku podršku kroz moje studiranje. Također se želim zahvaliti profesoru dr. sc. Roku Dejhalli na vodstvu i mentorstvu kroz pisanju diplomskog rada.

## Sadržaj

1. Uvod.....	1
2. Povijest metoda korištenih u projektiranju.....	2
3. Projektna spirala.....	7
4. Odabir glavnih dimenzija.....	9
4.1. Projektni zahtjev:.....	9
4.1.2. Yamaha 275 SD.....	10
4.1.3. Yamaha AR 250.....	10
4.1.4. Four Winns Horizon H290.....	11
4.1.5. Sea Ray SLX 350.....	12
4.1.6. Chris-Craft Launch 28 GT.....	12
4.1.7. 350 Crossover Bowrider.....	13
4.1.8. Cobalt A29.....	14
4.1.9. Formula 310 Bowrider.....	14
4.1.10. Chaparral 327 SSX.....	15
5. Odabir forme plovila.....	18
5.1. Parametri gliserske forme.....	20
6. Proračun masa.....	24
6.1. Masa pogonskog sustava.....	29
6.1.1. Izvanbrodski motor.....	29
6.1.2. Vodomlazni pogonski sustav.....	31
6.3. Masa goriva.....	33
6.3.1 Masa goriva izvanbrodskog motora.....	33
6.3.2. Masa goriva vodomlaznog pogonskog sustava.....	33
6.4. Masa lubrikacijskih i hidrauličnih ulja.....	34
6.5 Masa osoba.....	34
6.6. Masa tanka svježe vode.....	34

6.6. Masa tanka crne vode .....	34
6.7. Mase inventara.....	35
6.8 Projektna rezerva .....	35
7. Razmještaj .....	36
8. Proračun mase i težišta .....	37
8.1. Proračun mase i težišta za dva izvanbrodska motora .....	38
8.2 Proračun mase i težišta za vodomlazni pogonski sustav .....	41
8.3. Položaji težišta za izvanbrodski pogonski sustav .....	45
8.4. Položaji težišta za vodomlazni pogonski sustav .....	46
8.5. Položaji težišta za izvanbrodski pogonski sustav proširene forme.....	48
8.6. Položaji težišta za vodomlazni pogonski sustav proširene forme .....	49
9. Pliskanje .....	50
10. Odabir vodomlaznog pogonskog sustava.....	54
10.1 Određivanje poriva vodomlaznog propulzora .....	54
10.2. Odabir pogonskog motora .....	60
10.3 Odabir vodomlaznog propulzora .....	61
10. Odabir izvanbrodskog pogonskog sustava.....	64
10.1. Proračun otpora.....	64
10.2. Koeficijenti propulzije .....	65
10.3. Odabir pogonskog motora .....	67
10.4. Odabir brodskog vijka .....	69
10.4. Prognozni dijagram.....	70
10.5 Provjera poriva .....	71
11. Stabilitet plovila .....	73
12. Zaključak.....	76
Literatura .....	77



Popis slika .....	80
Popis tablica.....	83
Prilog 1.....	87
Prilog 2.....	89
Prilog 3.....	91
Prilog 4.....	120

## 1. UVOD

Jedna od definicija brodogradnje opisuje brodogradnju kao kompleksnu industriju koja se bavi projektiranjem i gradnjom brodova, odnosno plovila. Proces projektiranja i gradnje plovila je vrlo složen te se razina složenosti povećava sa sve većim zahtjevima koja su za to plovilo namijenjena. Zahtjevi za izvedbu plovila mogu biti razni, krenuvši od njegove veličine, brzine i namjene, ukratko ovise o potrebama vlasnika plovila. No kao i u svim granama inženjeringa pa tako i u brodogradnji kompleksnim problemima se pristupa na način da ih se podijeli na više manjih rješivih problema.

Proces izgradnje plovila kreće sa njegovim projektiranjem gdje se definira sva potrebna dokumentacija za njegovu izradu. Dokumentacija mora biti u skladu sa zakonskim propisima kako bi se osigurala sigurnost broda, posade i okoliša, a njeno definiranje može trajati i do godinu dana. Problematici projektiranja broda se pristupa na način da se u početku projektiranja odredi namjena plovila te njeni početni parametri. Nakon što su definirani osnovni parametri plovila, projektiranje se kreće u smjeru usavršavanja tog plovila. Namjena svih sljedećih koraka u projektiranju je ta kako bi završno plovilo i proces njene izgradnje bilo napravljeno na što efikasniji način, a da je i dalje u skladu sa zakonskim propisima. Jedan od ovakvih oblika projektiranja se naziva „Projektna spirala“ gdje se u svakoj iteraciji projektne spirale plovilo usavršava i bliži krajnjem proizvodu.

Tema ovoga rada je preliminarni projekt rekreacijskog brzog plovila, kao takva ona je dio projektne spirale i u njoj će biti opisan preliminarni dio projekta. U radu je je razrađen projektni zahtjev za projekt brzog motornog rekreacijskog plovila dužine 10-ak metara. Prema projektnom zahtjevu izrađen je preliminarni projekt plovila s pripadajućim proračunima, crtežom linija, općim planom i tehničkim opisom. Za propulzijski sustav analizirana je izvedba s brodskim vijcima te sa vodomlaznim propulzorima. U okviru preliminarnog projekta stabilitet plovila je provjeren prema normi EN ISO 12217-1:2017.

## 2. POVIJEST METODA KORIŠTENIH U PROJEKTIRANJU

Projektiranje plovila je jednostavno rečeno unaprijed dogovoren i zapisan proces izrade plovila. Način na koji se plovilo projektiralo kao i njeno dokumentiranje je zajedno sa tehnologijom evoluirao kroz povijest, razvijanjem tehnologije razvili su se novi načini i nove metode izrade plovila. Prva izrađena plovila poznata čovjeku su kanui napravljeni od izdubljenog debla i datiraju još 8000. godina prije Krista, u tom razdoblju njihovi ostatci su pronađeni na sjeveru Afrike, sjeveru Europe i na istočnom dijelu Azije [1]. Kanui su napravljeni pomoću primitivnih alata napravljenih od kamena. Vanjski dio debla od kojeg je kanu napravljen se oblikovao pomoću alata kao i površinski dio debla koji se korištenjem alata izdubio, slika 2.1. Ostatak debla bi se zatim izdubio pomoću kontrolirane vatre te bi se oblikovao umetanjem grana između bočnih dijelova kanua. Ovakav oblik plovila i njegov način izrade je pronađen u raznim dijelovima svijeta, na ovaj način možemo vidjeti na koji način su prvi graditelji plovila razmišljali i kako su se po svijetu širile prve informacije koju su sadržavale način izrade plovila.



*Slika 2.1. Kanu od izdubljenog debla [2]*

Prvi zapisi o izradi plovila datiraju 4000 godina prije Krista, u područja Egipta te se u obliku slika i hijeroglifa nalaze na grobnicama, spomenicima, svitcima i vazama. Za Egipćane plovila su bila od iznimne životne i religijske važnosti stoga se njihovi zapisi pojavljuju na mnogim mjestima. Zapisi egipatskih plovila nisu bili detaljni no daju na uvid oblik plovila, materijal od kojih su bila napravljena te svrhu za koju su korištena kao što je prikazano na slici 2.2. Rani zapisi govore o upotrebi biljke papirusa koje je bilo u izobilju na obalama Nila, upotrebom užeta i kože snopovi papirusa su se oblikovali u plovila koja izgledom podsjećaju na sadašnje kanue.

Oko 3000 godina prije Krista upotreba drveta, koje do tada nije bilo lako dostupno u velikim količinama radi područja siromašnog šumama, je omogućilo izradu velikih brodova poput egipatske Nave. Drveni brodovi su se gradili pomoću užeta i dasaka, te su za plovidbu uz vesla koristili i križna jedra [3]. Kako procesi izrade u tom razdoblju nisu bili detaljno zapisani, može se zaključiti kako se znanje o izradi egipatskih plovila prenosilo s koljena na koljeno.

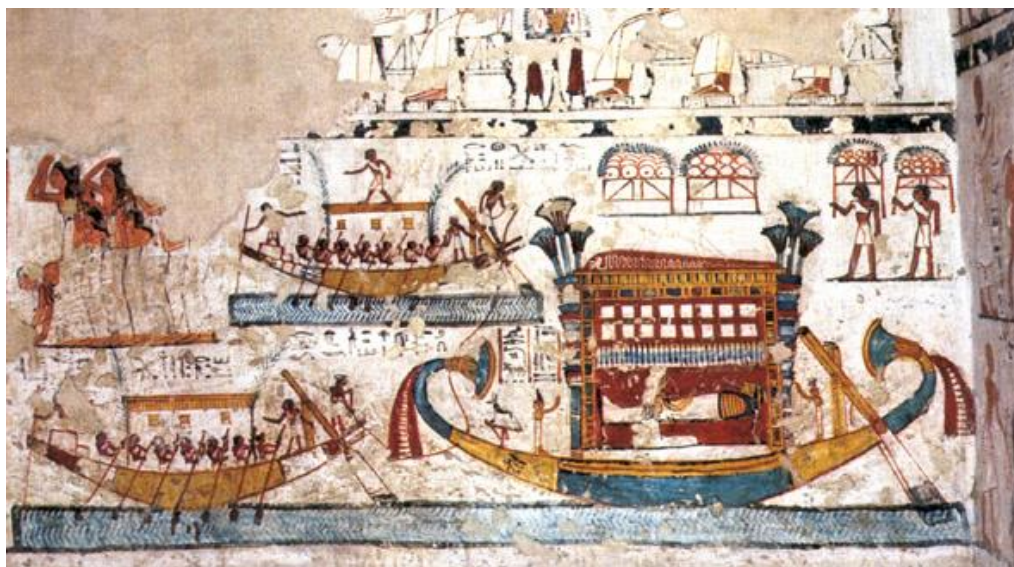

*Slika 2.2 Zapisi egipatskih plovila [4]*

Za vrijeme starog Egipta koristile su se osnove aritmetike i geometrije koje su se većim dijelom zasnivale na zbrajanju te mjerne jedinice poput kraljevskog lakta (duljina), sestata (površina) i hekata (volumen). Unatoč upotrebi matematike gradnja plovila se i dalje zasnivala na iskustvu koje se usavršavalo generacijama. Prva upotreba matematičkih i znanstvenih principa pri izradi plovila poput primjene poluge, „Arhimedovog zakona“ i „Metode iscrpljivanja“ se upotrebljava u doba starih Grka, razdoblje oko 500 godina prije Krista. Povjesničari poput Homera, Hesioda i Herodotusa su u svojim zapisima uz mnoge druge aspekte života starih Grka opisivali i način na koji su se brodovi u to vrijeme gradili. Na slici 2.3 je prikazana replika trijere, poznati starogrčki ratni brod koji je napravljen prema slikama i zapisima povjesničara. Gradnja brodova je uvijek započela sa kobilicom napravljenom od jednog komada drveta iz koje se „izdizala“ oplata napravljena od dasaka spojenih sa čavlima i užetom. Nakon što je gradnja oplata bila gotova između bokova brodova su se postavljala poprečna ojačanja nalik današnjim rebrima na koja su se zatim postavljale palube. Kako bi se zaštitili od obrastanja većina brodova je na podvodni dio broda stavljala sloj olova [5]. Kao i u vrijeme starog Egipta brodovi su bili pogonjeni veslima i velikim križnim jedrima te je bitno za napomenuti da su veliki trgovački brodovi toga vremena imali nosivost do čak 400 tona.

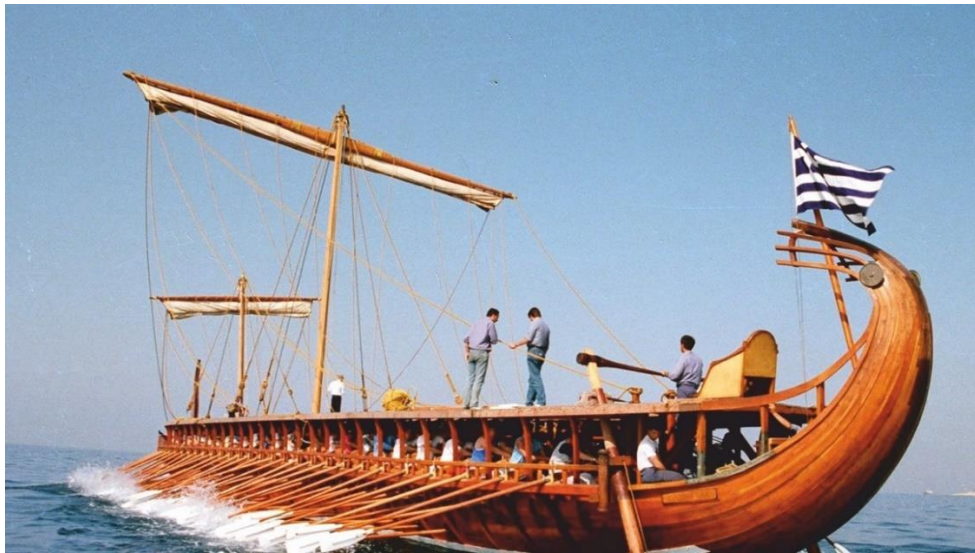

*Slika 2.3. Replika starogrčke trijere [6]*

Kroz srednji vijek gradnja plovila se uvelike promijenila te je uveden veliki broj inovacija koje su povećale njihovu efikasnost. Eksperimentiranja sa novim oblicima trupova su rezultirala sužavanjem pramčanog dijela i proširenjem krmenog dijela broda čime se povećala brzina i upravljivost brodova. Uporaba novih materijala, specifičnih vrsta drva poput hrasta i brijesta, je omogućilo gradnju čvršćih brodova sa većom nosivosti i većim brojem paluba. Vertikalno kormilo je omogućilo bolju kontrolu zakretanjem plovila, a novi oblici jedara kao i njihova upotreba su omogućili plovidbu niz vjetar. Iako su brodovi svojim izgledom i izvedbom bili puno kompleksniji i dalje nisu postojala utemeljena pravila i odrednice prema kojima se gradili. Znanje o gradnji brodova se i dalje zasnivalo na određenim matematičkim i znanstvenim principima no velikom većinom i prema iskustvu brodograditelja koje se usmenim putem prenosilo na sljedeće generacije. Zapisi i knjige autora Theophilus Presbytera, Ibn Majida i Walter of Henleya sadrže informacije o načinu na koji su se brodovi gradili za vrijeme srednjeg vijeka. Iz zapisa srednjovjekovnih autora može se vidjeti kako su se brodovi gradili na način da je prvo napravljena unutarnja struktura broda koja je sadržavala kobilicu, rebra, uzdužna i poprečna ojačanja, pregrade i palube. Na strukturu broda se zatim stavljala oplata, a postavljanje oplata se obavljalo tehnikom preklapanjem platica oplata. Vodonepropusnost i zaštita od obrastanja se zatim postizala korištenjem zakrpa od katrana i slojem olova [7]. Na slici 2.4 je prikazana olupina Koge, jedrenjaka iz 14. stoljeća pronađenog u Švedskoj gdje se detaljno vidi kako je izgledala struktura brodova srednjeg vijeka. Izgradnja brodova u srednjem vijeku je bio kompleksan proces koji je u nekim slučajevima trajao i do nekoliko godina te je zahtjeva velik broj stručnjaka i radnika.



*Slika 2.4. Slika eskavacije olupine Koge [8]*

Doba renesanse predstavlja veliku prekretnicu u pristupu projektiranja brodova. Brodograditelji renesanse su bili u mogućnosti zaključiti karakteristike broda iz priloženih nacrti, slika 2.5, te kako prilagoditi projekt broda metodama koje su se zasnivale na matematičkim i znanstvenim principima. Pri projektiranju su se koristili zakoni hidrostatičke i hidrodinamičke uporabe Bernulijevog zakona, računanja otpora valova, korištenje vodnih linija te izračunavanja težišta plovila i težišta istisnine. Uporaba matematičkih principa je omogućila rješavanje kompleksnih pitanja poput otpora, brzine i stabilnosti broda [9]. Također projektiranje brodova se uvelike temeljilo na korištenju skaliranih modela pomoću kojih su se radile preinake na projektu broda. Jedna od bitnih figura u razvoju brodogradnje za vrijeme renesanse je Filippo Brunelleschi, talijanski arhitekt koji je dizajnirao prvo moderno brodogradilište te među prvima koristio detaljne planove i nacрте pri izgradnji brodova. Engleski brodograditelji Mathew Baker i William Kellie su također za vrijeme renesanse svojim radovima velikim dijelom pridonijeli sistematizaciji i standardizaciji pri projektiranju broda.

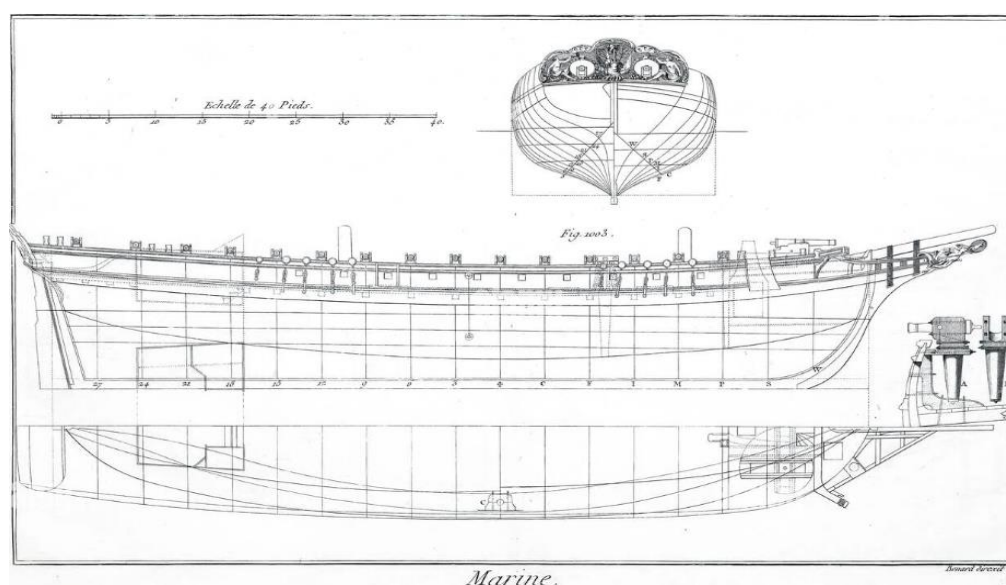

*Slika 2.5. Nacrt broda u doba Renesanse [10]*

Polovica 19. stoljeća označila je kraj korištenja energije vjetra kao glavnog pogona plovila. Pojava parne turbine je revolucionirala industriju kao cijelu pa tako i brodogradnju te su jedrenjaci polako zamijenjeni parobrodima, slika 2.6. Korištenje novog pogona kao i korištenje željeza i čelika kao glavnog materijala je uvelike promijenilo pristup projektiranju broda. Brodovi su postali veći i brži, oblik trupa se znatno promijenio kao i unutarnja struktura broda, projektiranje željeznih i čeličnih brodova je za sobom nosilo mnoge nove izazove. Matematički i znanstveni principi prema kojima su se gradili brodovi su se bazirali prema principima otkrivenim za vrijeme Renesanse no njihovo razumijevanje je bilo puno sofisticiranije. Korištenje skaliranih modela u bazenima pri kontroliranim uvjetima je unaprijedilo razumijevanje hidrodinamike. Korištenje diferencijalnih jednažbi je omogućilo bolje razumijevanje dinamike fluida. Uvedena je statistička analiza kao i teorija vjerojatnosti koje su omogućile predviđanje ponašanja brodova u različitim uvjetima [11].



*Slika 2.6. Slika parobroda [12]*

U današnje vrijeme projektiranje plovila se zasniva na kombinaciji tradicionalnog pristupa i nove tehnologije. Novi materijali te uporaba strojeva i računala koja su velikim dijelom zamijenila ljudsku snagu su omogućila puno efikasniji pristup projektiranju. Uporaba računala je unaprijedila i ubrzala gotovo sve procese koji su se obavljali ručno te omogućila puno detaljnije i točnije proračune sa smanjenom mogućnosti grešaka. Korištenje CADA-a, CFD-a i FEA je omogućilo simuliranje velikog broja različitih uvjeta i analizu performansi plovila kao i njegove unutarnje strukture i prije korištenja skaliranih modela [13]. Detaljne informacije o plovilu, potrebnim materijalima i samoj tehnologiji izrade je danas omogućilo vrlo efektivno i ekonomično projektiranje.

### 3. PROJEKTNJA SPIRALA

J. Harvey Evans je 1959. vizualizirao proces projektiranja plovila pomoću metode projektne spirale i danas ta metoda predstavlja jedan od bitnih „alata“ svih brodograditelja. Koristeći projektnu spiralu proces projektiranja broda je sistematski podijeljen na četiri glavne faze: idejni projekt, preliminarni projekt, ugovorni projekt i detaljni projekt, slika 3.1. Krećući se kroz spiralu sve do njezine jezgre koja predstavlja gotov projekt, svakom iteracijom saznaje se informacije o plovilu.

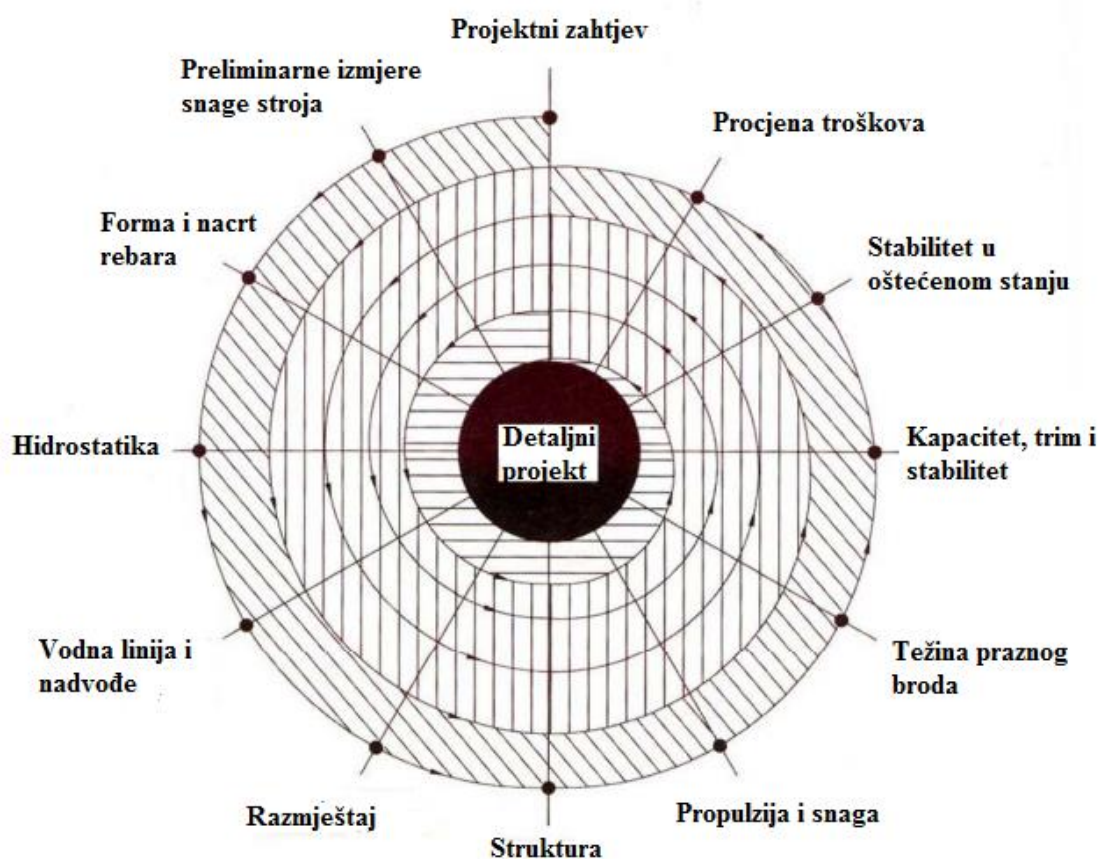

Slika 3.1. Vizualizacija projektne spirale

Idejni projekt je prva faza u kojoj se određuju glavne karakteristike plovila poput: duljine, širine, gaza, nosivosti i brzine. Na temelju glavnih karakteristika se određuju detaljniji tehnički podaci i skica plovila. Nakon preliminarne faze glavne karakteristike broda se neće mijenjati u daljnjim iteracijama te se na temelju njih razrađuju podaci o pogonskom stroju, bruto i neto tonaži te geometrijskim obilježjima plovila. Na kraju preliminarne faze dokumentacija mora sadržavati tehnički opis, opći plan i preliminarni plan rebara. U ugovornom projektu se opširno razrađuje tehnički opis plovila na osnovu kojeg se potpisuje ugovor. Na temelju tehničkog opisa se dalje izgladuje forma broda te se na temelju skaliranog modela broda odrađuju odgovarajući pokusi. Ugovorni projekt mora sadržavati dokumentaciju o:



- kapacitetnom planu
- preliminarnom prognoznom dijagramu
- popisu proizvođača
- detaljnom tehničkom opisu
- nacrtu glavnog rebra
- razmještaju električnih instalacija
- preliminarnoj knjizi trima i stabiliteta
- razmještaju
- stabilitetu broda u oštećenom stanju

Detaljni projekt je vremenski najzahtjevniji dio projektiranja. Sadrži sve podatke o radovima koji će se izvršiti u brodogradilištu. Budući radovi su zapisani u radnim planovima koji sadrže detaljne upute o svakom dijelu broda te načinu na koji će se konstruirati i instalirati.

## 4. ODABIR GLAVNIH DIMENZIJA

### 4.1. Projektni zahtjev:

Plovilo mora biti brzo, sigurno i udobno te mu je glavna namjena korištenje za rekreacijske svrhe obitelji i prijatelja.

1. Duljina plovila oko desetak metara.
2. Mogućnosti postizanja maksimalne brzine od 45 čvorova.
3. Doplov od maksimalno 150 morskih milja.
4. Vrsta propulzije: izvanbrodski ili vodomlazni propulzor.
5. Vrsta plovila: gliser s pramčanim kokpitom (engl. bowrider ili engl. deck boat),
6. Osigurati dovoljno prostora za minimalno šestero ljudi.
7. Stabilnost plovila pri visokim brzinama i prilikom izvođenja okreta.
8. Plovilo mora sadržavati tvrdi brodski krov ili tendu.
9. Plovilo mora sadržavati platformu za plivanje sa integriranim tušom.

U nastavku su prikazana postojeća plovila na današnjem tržištu čije su karakteristike podloga za nastavak odabira forme plovila kao i njegovih glavnih dimenzija.

#### 4.1.1. Scarab 255 Impulse Wake Edition

Scarab 255 Impulse Wake Edition je rekreacijski gliser s naglaskom na performansu, poznat po svojim sposobnostima za daskanje na krmenom valu (engl. wakeboarding). Dva Rotax pogonska motora pružaju izvrsnu brzinu, upravljivost i sigurnost. Opremljen sa tornjem za konop za vuču, sustavom za balast i prostranom kabinom pruža uzbudljivo i udobno iskustvo za zaljubljenike u vodene sportove.



Slika 4.1. Slika glisera Scarab 255 Impulse Wake Edition [15]

Tablica 4.1. Osnovne karakteristike glisera Scarab 255 Impulse Wake Edition

Duljina	7,60 m	Pogon	Vodmlazni pogon - 2 x Rotax 4-Tec
Širina	2,54 m	Snaga	2x 187 kW
Gaz	0,38 m	Brzina	49,53 čv
Masa	1,66 t	Kut nagiba dna	20 °

#### 4.1.2. Yamaha 275 SD

Yamaha 275 SD je Yamahin najveći gliser sa vodmlaznim pogonom poznat po hiper-upravljivim sposobnostima. Prostrana paluba kao i tvrdi krov pružaju udobnost i ugođaj na vodi. Opremljen snažnim Super Vortex motorima, INR sustavom i sustavom preciznog dokovanja Yamaha 275 SD osigurava izvrsno ubrzanje i upravljivost broda.



Slika 4.2. Slika glisera Yamaha 275 SD [16]

Tablica 4.2. Osnovne karakteristike glisera Yamaha 275 SD

Duljina	8,23 m	Pogon	Vodmlazni pogon- Yamaha 1.8 Liter, Super Vortex
Širina	2,74 m	Snaga	2x 187 kW
Gaz	0,56 m	Brzina	44,7 čv
Masa	2,48 t	Kut nagiba dna	20 °

#### 4.1.3. Yamaha AR 250

Yamaha AR 250 je rekreacijski gliser sa vodmlaznim pogonom s naglaskom na udobnost i performans. Opremljen je Yamahinim motorima velike snage koji omogućavaju brzu i sigurnu vožnju na vodi. Prostrana paluba sa platformom za plivanje, prostorom za skladištenje i brojnim sjedalima je idealna za obiteljske izlete ili druženje s prijateljima.



Slika 4.3. Slika glisera Yamaha AR 250 [17]

Tablica 4.3. Osnovne karakteristike glisera Yamaha AR 250

Duljina	7,47 m	Pogon	Vodomlazni pogon - Yamaha 1.8 Liter, High Output
Širina	2,59 m	Snaga	2x 187 kw
Gaz	0,48 m	Brzina	43,5 čv
Masa	1,8 t	Kut nagiba dna	20 °

#### 4.1.4. Four Winns Horizon H290

Four Winns Horizon H290 je elegantan rekreacijski brod visokih performansi koji pruža luksuz i zabavu na vodi. Palubu obilježava posebno dizajniran vjetrobran sa središnjim prolazom, pomično skladište na krmi te opcijnska kuhinja. Pokreću ga dva MerCruiser motora koji pružaju brzu i glatku vožnju, brod je idealan za opuštajuće izlete i druženje s prijateljima.



Slika 4.4. Slika glisera Four Winns Horizon H290 [18]

Tablica 4.4. Osnovne karakteristike glisera Winns Horizon H290

Duljina	9,2 m	Pogon	Unutarnji motor - MerCruiser Twin 6.2L
Širina	2,8 m	Snaga	2x 224 kW
Gaz	0,99 m	Brzina	35 čv
Masa	3,856 t	Kut nagiba dna	21 °

#### 4.1.5. Sea Ray SLX 350

Sea Ray SLX 350 je rekreacijski gliser koji spaja sportski performans i luksuzne značajke. Paluba je opremljena pomičnom platformom za plivanje, zatvorenom ložom, prostorom za skladištenje te prostranim sjedalima. Opremljen sofisticiranim sustavima za kontrolu i navigaciju, Sea Ray SLX 350 omogućuje glatku vožnju i precizno upravljanje.



Slika 4.5. Slika glisera Sea Ray SLX 350 [19]

Tablica 4.5. Osnovne karakteristike glisera Sea Ray SLX 350

Duljina	10,52 m	Pogon	Unutarnji motor - MerCruiser Twin 6.2L
Širina	3,2 m	Snaga	2x 224 kW
Gaz	0,99 m	Brzina	36,5 čv
Masa	6,3 t	Kut nagiba dna	21 °

#### 4.1.6. Chris-Craft Launch 28 GT

Chris-Craft Launch 28 GT je rekreacijski gliser koji spaja klasični dizajn s modernim značajkama. Sa naglaskom na udobnost paluba je izrađena od visoko kvalitetnih materijala sa prostranim pomičnim sjedalima. Opremljen snažnim vanjskim Volvo V8 motorom Chris-Craft Launch 25 GT pruža sigurnu vožnju i na nemirnom moru.



Slika 4.6. Slika glisera Chris-Craft Launch 28 GT [20]

Tablica 4.6. Osnovne karakteristike glisera Chris-Craft Launch 28 GT

Duljina	8,13 m	Pogon	Vanjski motor – Mercury Verado
Širina	2,60 m	Snaga	298 kW
Gaz	0,92 m	Brzina	43,44 čv
Masa	2,753 t	Kut nagiba dna	20 °

#### 4.1.7. 350 Crossover Bowrider

350 Crossover Bowrider je Formula Boats gliser koji kombinira funkcionalnost glisera spramčanim kokpitom s mogućnostima noćenja. Sa kabinom i kuhinjom smještenima ispod palube uvelike se razlikuje od ostalih s pramčanim kokpitom brodova. Opremljen sa dva Mercruiser motora 350 Crossover Bowrider pruža impresivne performanse i upravljanje na vodi.



Slika 4.7.Slika glisera 350 Crossover Bowrider [21]

Tablica 4.7. Osnovne karakteristike glisera 350 Crossover Bowrider

Duljina	10,67 m	Pogon	Izvanborski motor - Mercruiser 377 Mag, ECT
Širina	3,28 m	Snaga	2x 239 kW
Gaz	0,99 m	Brzina	48 čv
Masa	6,509 t	Kut nagiba dna	21 °

#### 4.1.8. Cobalt A29

Cobalt A29 je rekreacijski gliser koji kombinira zabavu i performans. Prostrana paluba i udobna sjedala te oprema poput pomične platforme za plivanje i inovativne „splash & stove“ platforme su idealni za obiteljska druženja i vodene sportove. Unutarnji motor Volvo Penta V8 omogućava izvrsno ubrzanje i vrhunski performans.



*Slika 4.8. Slika glisera Cobalt A29 [22]*

*Tablica 4.8. Osnovne karakteristike glisera Cobalt A29*

Duljina	8,84 m	Pogon	Unutarnji motor -Volvo Penta V8-430CE DP
Širina	2,74 m	Snaga	321 kW
Gaz	0,97 m	Brzina	41,7 čv
Masa	3,3 t	Kut nagiba dna	21 °

#### 4.1.9. Formula 310 Bowrider

310 Bowrider je Formulin najveći bowrider glisera naglaskom na brzinu i performans. Kut nagiba dna od 22 ° i duboki-V trup omogućuje izvrsno ubrzanje i jako dobru upravljivost na nemirnom moru. Opremljen snažnim Volvo Penta motorima, Formula 310 Bowrider pruža impresivnu brzinu i precizno upravljanje.



*Slika 4.9. Slika broda Formula 310 Bowrider [23]*

Tablica 4.9. Osnovne karakteristike broda Formula 310 Bowrider

Duljina	9,45 m	Pogon	Vanjski motor – Mercruiser 377 Mag, ECT
Širina	2,9 m	Snaga	2x 239 kW
Gaz	0,94 m	Brzina	47 čv
Masa	4,91 t	Kut nagiba dna	22 °

#### 4.1.10. Chaparral 327 SSX

327 SSX je inovativan bowrider Chaparral-ea koji kombinira luksuz, performans i iznimnu funkcionalnost. Opremljen velikim brojem sjedala kao i kabinom pametno smještenom u prednjem dijelu broda omogućava jako prostranu paluba te mogućnost noćenja. Snažni MerCruiser motorima i naprednim navigacijskim sustavom 327 SSX nudi izvrstan performans.



Slika 4.10. Slika glisera Chaparral 327 SSX [24]

Tablica 4.10. Osnovne karakteristike glisera Chaparral 327 SSX

Duljina	9,91 m	Pogon	Unutarnji motor - MerCruiser 8.2L MAG
Širina	3,05 m	Snaga	2x 283 kW
Gaz	0,94 m	Brzina	49,7 čv
Masa	4,627 t	Kut nagiba dna	22 °

O navedenim brodovima su uzeti podaci o njihovim osnovnim karakteristikama te su pomoću programa CADRE Regression napravljeni polinomi trećega stupnja, odnosno regresijske krivulje koje opisuju određene karakteristike brodova u ovisnosti o njihovoj duljini, slika 4.11. Regresijske krivulje su napravljene kako bi se preciznije odredile osnovne karakteristike za plovilo koje se projektira.



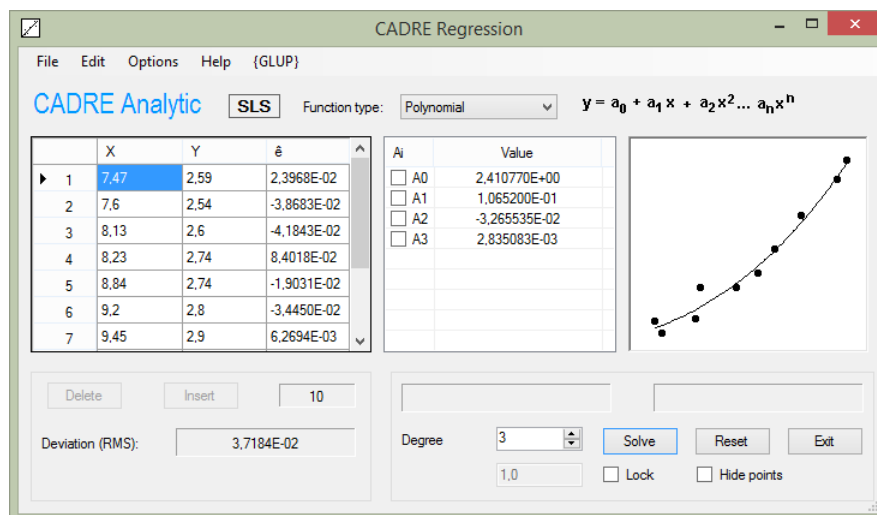

Slika 4.11. Računanje polinoma

U nastavku su prikazani dijagrami napravljeni pomoću dobivenih polinoma.

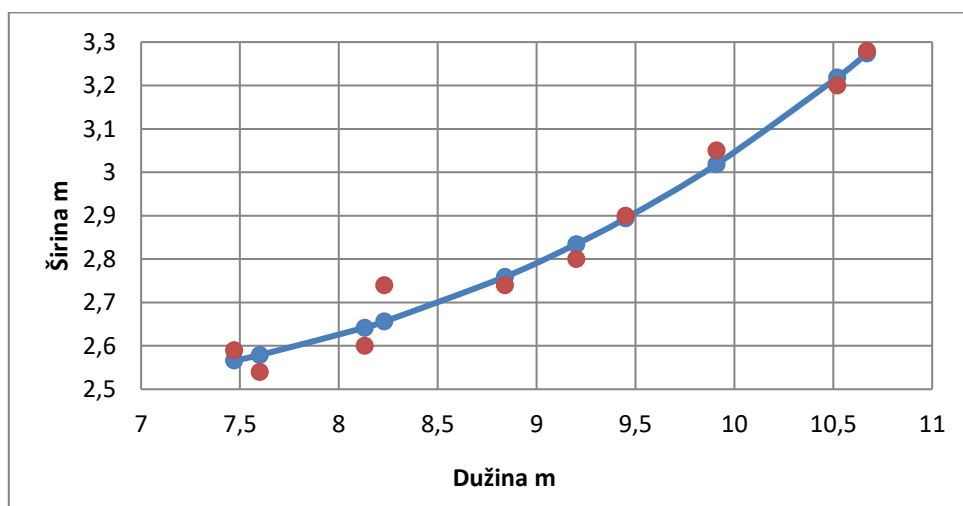

Slika 4.12. Ovisnost širine o dužini plovila

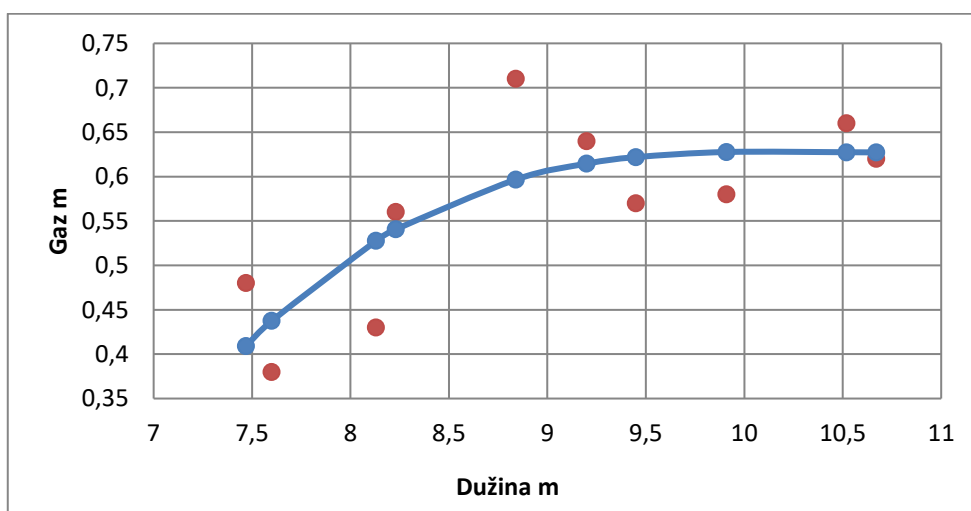

Slika 4.13. Ovisnost gaza o dužini plovila

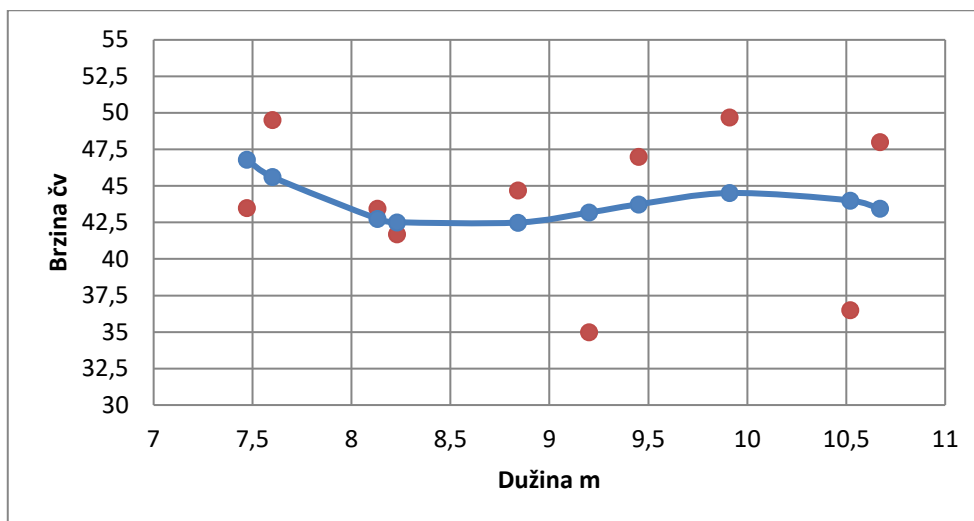

Slika 4.14. Ovisnost brzine o dužini plovila

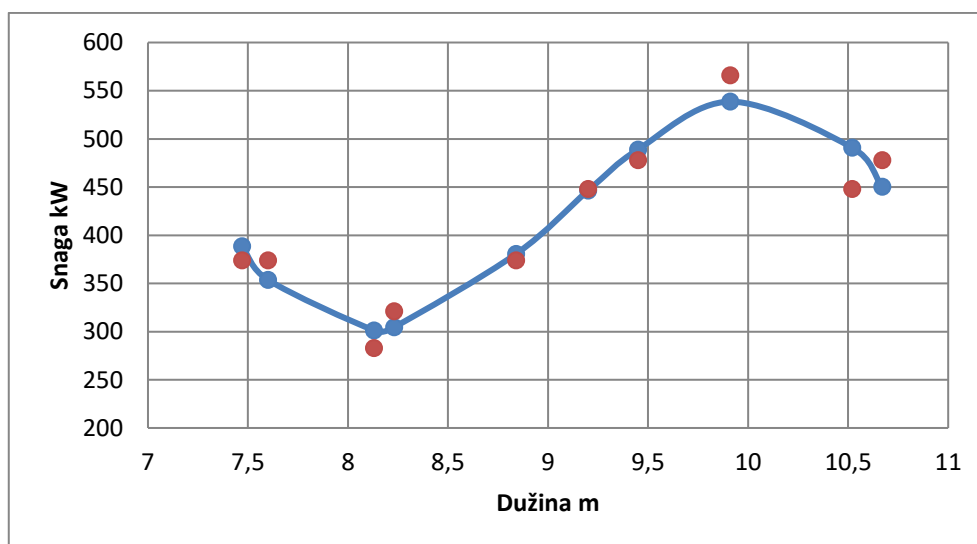

Slika 4.15. Ovisnost snage o dužini plovila

Za dužinu broda je odabrana vrijednost od 10,5 m. Prema odabranoj dužini pomoću regresijskih krivulja dobivene su osnovne karakteristike projektiranog broda, prikazane u tablici 4.11.

Tablica 4.11. Osnovne karakteristike projektiranog plovila

Dužina	10,5	m
Širina	3,2	m
Gaz	0,63	m
Brzina	43,5	čv
Snaga	490	kW

## 5. ODABIR FORME PLOVILA

Za formu plovila je odabrana duboka V forma sa kutom nagiba dna na krmenom zrcalu od  $22^\circ$ . Ono što karakterizira duboku V formu je kut nagiba dna od  $20^\circ$  do  $25^\circ$  što rezultira oštro oblikovanim dnom koje se neprekidno proteže od krme do pramca. Pogled na formu plovila sa krme podsjeća na slovo „V“ prema čemu je forma i dobila ime. Prednost odabira duboke V forme naspram drugih je velika stabilnost plovila i dobre značajke pri velikim velikim brzinama na mirnoj vodi i na nemirnom moru. Također, oštro oblikovano dno omogućava da plovilo lakše „reže“ kroz vodu čime više ublažuje udarce u vodu što naposljetku čini vožnju glađom i ugodnijom.

Navedene karakteristike duboke V forme su vrlo povoljne za brza plovila. Gliseri s pramčanim kokpitom ili s pramčanom palubom, vrste plovila navedene u projektnom zahtjevu, također spadaju u brza plovila, no ono što ih razlikuje od većine brzih plovila su sjedala smještena na pramčanom dijelu palube. Prednost većeg broja sjedala je veća udobnost i mogućnost smještaja većeg broja ljudi, no takva izvedba dolazi i sa određenim sigurnosnim problemima. Pri većim brzinama ljudi smješteni na pramcu su podložni udarcima u vodu što može rezultirati ozljedama ili čak ispadanju iz plovila. Navedeni sigurnosni problem je jedan od najvećih razloga zašto je izabrana duboka V forma s kut nagiba dna od  $22^\circ$

Na internetu je pronađen crtež linija za duboku V formu sa kutom nagiba od  $22^\circ$ , slika 5.1. Crtež linija je poslužio kao podloga prema kojoj će se razviti forma glisera koja će zadovoljiti projektne zahtjeve. Forma glisera je modelirana u programu Rhinoceros 3D.

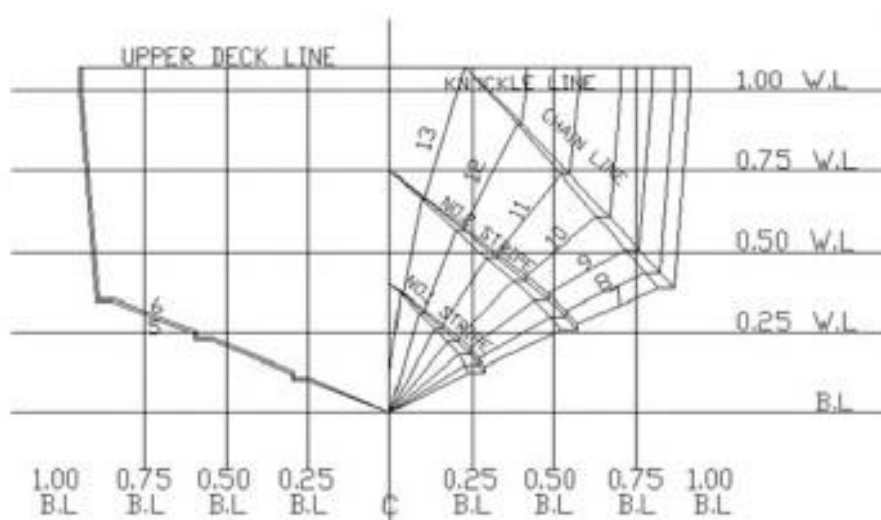

Slika 5.1. Plan linija za duboku V formu

Pomoću crteža rebara prema parametrima iza tablice 4.11. razvijena je duboka V forma, prikazana na slici 5.2.

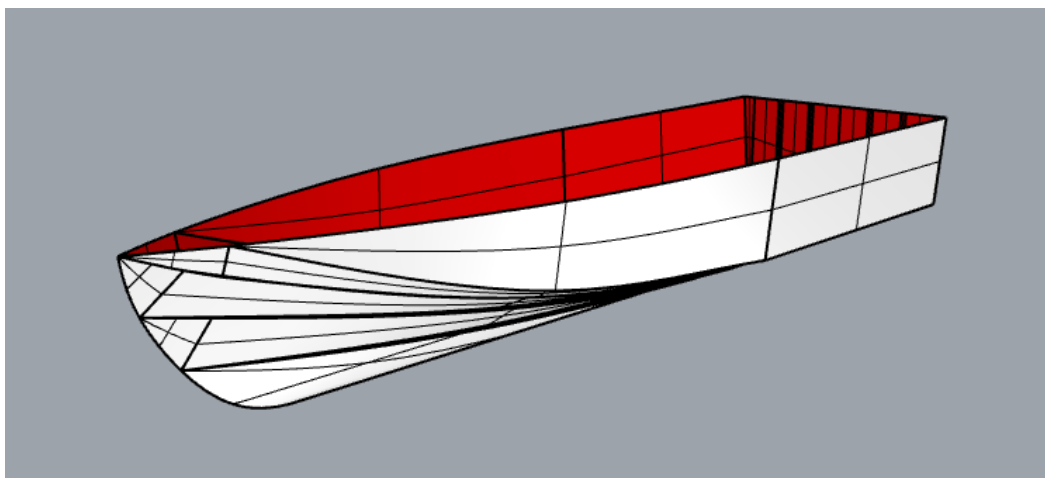

*Slika 5.2. Razvijena duboka V forma*

Za vrste brzih plovila poput glisera s pramčanim kokpitom ili s pramčanom palubom razvijena forma ne odgovara jer preveliko sužavanje pramčanog dijela ne ostavlja dovoljno prostora za postavljanje dodatnih sjedala. Kako bi se riješio ovaj problem odlučeno je proširiti pramčani dio forme, no prije proširenja potrebno je izabrati između dvije vrste brodova. Glavna razlika između glisera s pramčanim kokpitom i onih s pramčanom palubom brodova je oblik palube, slika 5.3. Gliseri s pramčanom palubom imaju puno širu palubu na pramčanom dijelu što omogućava više mjesta i mogućnost smještaja većeg broja ljudi. Uži oblik glisera s pramčanim kokpitom omogućava bolje značajke pri grubljim uvjetima i većim brzinama. Projektirano plovilo će se koristiti na otvorenom moru, radi boljih značajki pri grubljim uvjetima koje plovilo čine sigurnijim izabrana je forma glisera s pramčanim kokpitom.

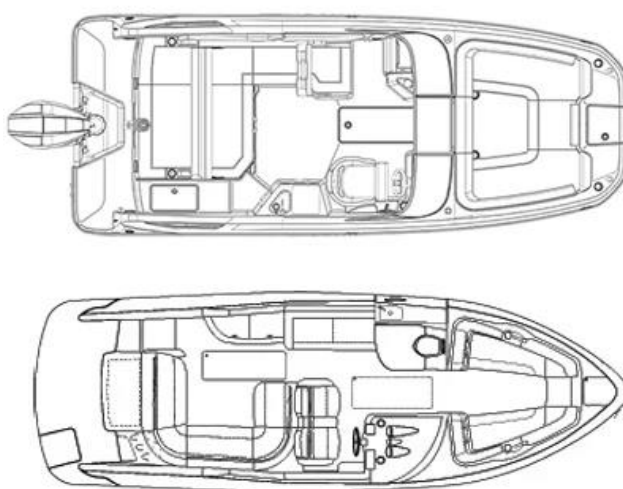

*Slika 5.3. Oblik glisera s pramčanom palubom i glisera s pramčanim kokpitom*

Nakon što je odabrana forma za gliser s pramčanim kokpitom, napravljeno je proširenje pramčanog dijela razvijene forme prikazano na slici 5.4.

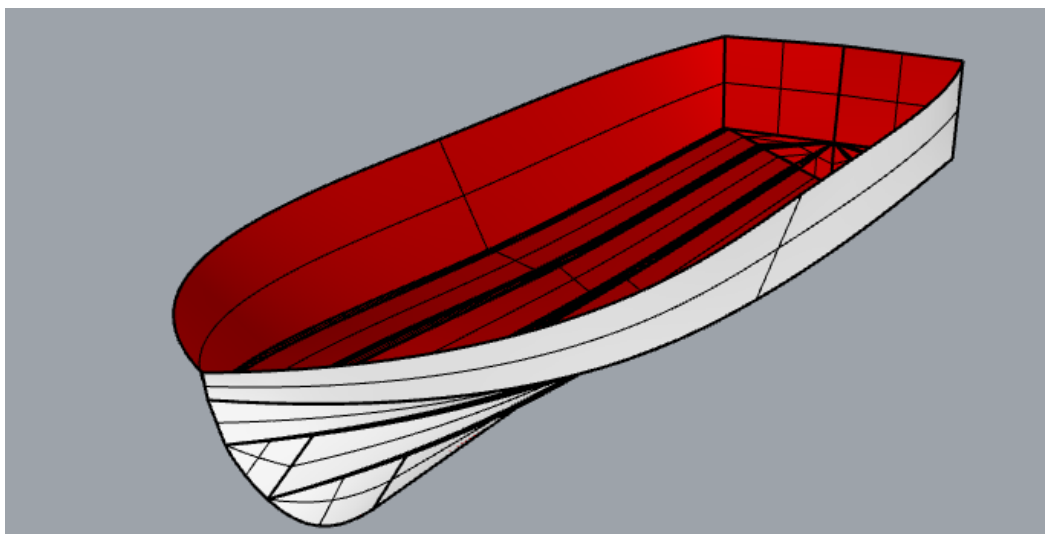

*Slika 5.4. Proširenje pramčanog dijela razvijene forme*

### **5.1. Parametri gliserske forme**

Nakon proširenja pramčanog dijela provjereni su parametri gliserske forme kako bi se dobio uvid u hidrodinamičke značajke forme. Pri provjeravanju parametara korišten je gaz od 0,63 m. Forma glisera je dalje modificirana kako bi dobiveni rezultati što više zadovoljavali parametre gliserske forme, odnosno kako bi se forma što više približila krajnjoj formi broda.

Parametri gliserskih formi su sljedeći:

- koeficijent opterećenja
- omjer projicirane duljine i srednje širine zgiba
- pozicija uzdužnog položaja težišta
- zakrivljenost uzdužnice na dnu na udaljenosti  $1/4 B$  od simetrale plovila
- Oblik zgiba u tlocrtu
- Oblik rebara
- Oblik areale rebara

Koeficijent opterećenja je prikazan formulom:

$$\frac{A_P}{\sqrt{2/3}} \quad (5.1)$$
$$A_P = 19,617$$

$$\nabla = 6,037$$

$$\frac{A_P}{\nabla^{2/3}} = 5,917$$

Za dobre hidrodinamičke značajke poželjno je da je vrijednost koeficijenta opterećenja u rasponu od 5,5 do 6,5.

Omjer projicirane duljine i srednje širine zgiba je prikazan formulom:

$$\frac{L_{PR}}{B_{PA}} \quad (5.2)$$

$$L_{PR} = 9,45$$

$$B_{PA} = 2,78$$

$$\frac{L_{PR}}{B_{PA}} = 3,399$$

Za dobre hidrodinamičke značajke poželjno je da je vrijednost omjera projicirane duljine i srednje širine projekcije zgiba u rasponu od 2,6 do 3,4.

Pozicija uzdužnog položaja težišta je prikazana formulom:

$$L_{CG} \approx L_{CAp} - 0,06 \cdot L_{PR} \quad (5.3)$$

$$L_{CAp} = 4,14$$

Iz razloga što uzdužni položaj težišta plovila nije poznat ovaj parametar nije zadovoljen.

Zakrivljenost uzdužnice na dnu na udaljenosti  $1/4 B$  od simetrale plovila je prikazana na slici 5.5. Zakrivljenost uzdužnice na dnu u odnosu na horizontalnu ravninu koja dodiruje kobilicu plovila može odstupati za maksimalno  $\pm 1^\circ$ .

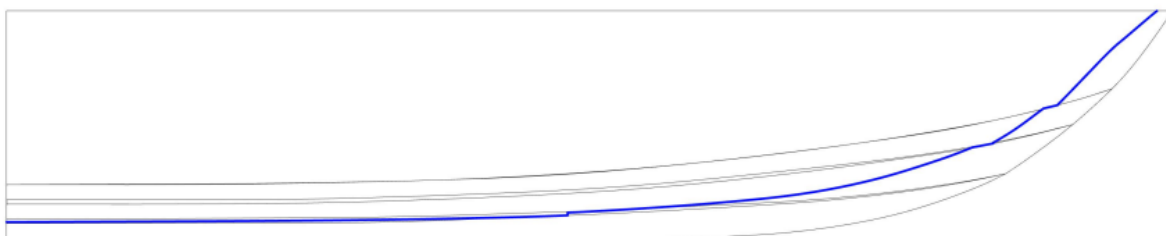

*Slika 5.5. Zakrivljenost uzdužnice*

Oblik zgiba u tlocrtu je prikazan na slici 5.6. Oblika zgiba je označen plavom bojom.

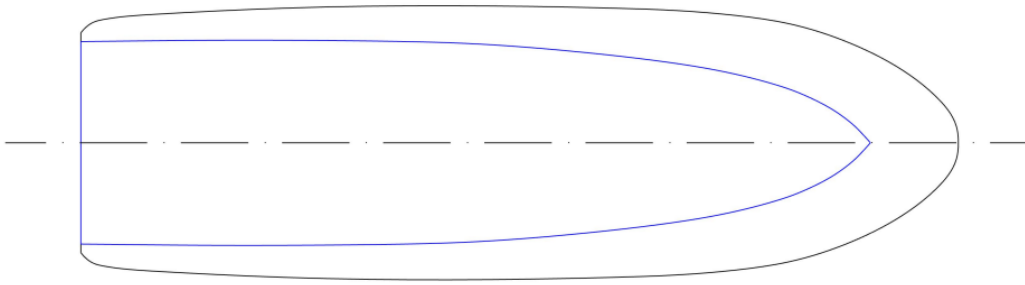

*Slika 5.6. Oblik zgiba u tlocrtu*

Oblik rebara je prikazan na slici 5.7.

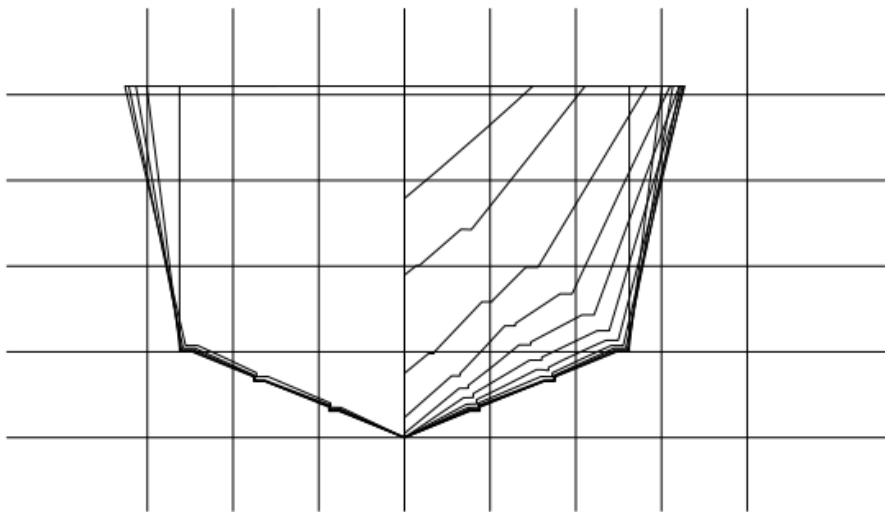

*Slika 5.7. Oblik rebara*

Oblik areale rebara je pomoću dijagrama prikazan na slici 5.8.

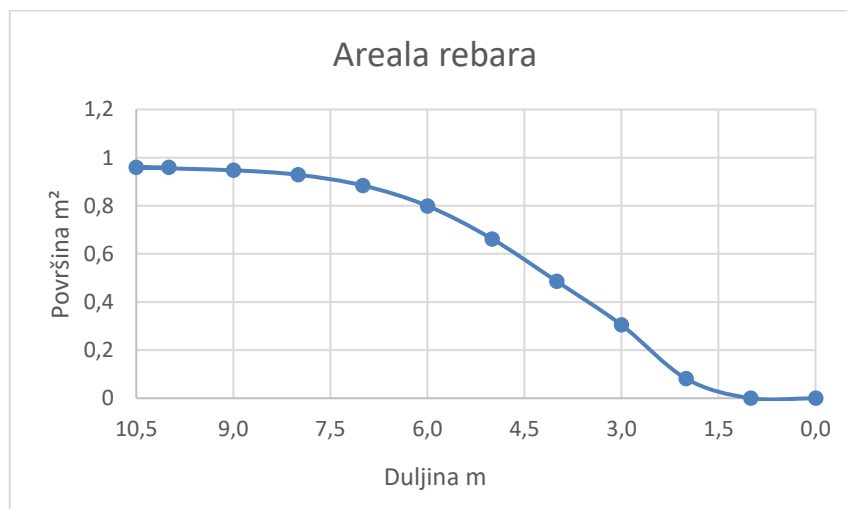

*Slika 5.8. Areala rebara*

Modificirana forma broda je prikazana na slici 5.9.

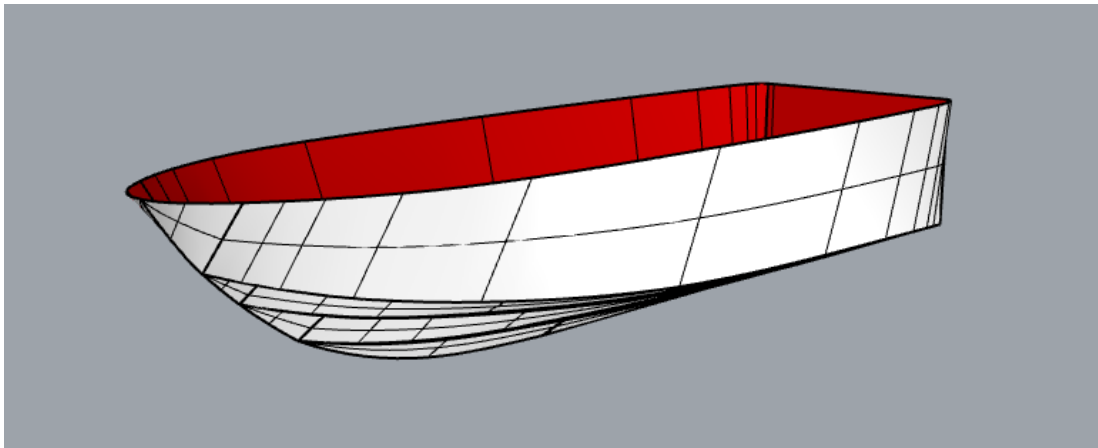

*Slika 5.9. Modificirana forma broda*

Kako bi se poboljšale hidrodinamičke značajke plovila, pri razvijanju forme su korišteni brizgobrani i uzdužne strujne vodilice, a njihove pozicije i dimenzije su razvijene prema crtežu rebara, slika 5.1. Brizgobrani su profili koji se protežu uzduž bokova plovila te se nalaze na zgibu brodu, odnosno na dijelu gdje se strane plovila spajaju sa dnom plovila, na slici 5.6. su označeni zelenom bojom. Brizgobrani usmjeravaju prskanje vode koje nastaje uslijed djelovanja valova, glisiranja ili kombinacije oba slučaja. Usmjeravanjem vode se generira dodatani uzgon, smanjuje zapljuskivanje i štiti posada od prskanja vode. Uzdužne strujne vodilice su profili koji se nalaze na dnu broda, manje su širine od brizgobrana te njihov broj i pozicija ovisi o izgledu i namjeni trupa, na slici 5.10. su označene plavom bojom. Postavljene su na pozicijama koje omogućuju da se strujanje vode na dnu plovila što ranije odvoji od trupa. Ranim usmjeravanjem toka vode se smanjuju trenje, zapljuskivanje i prskanje vode.

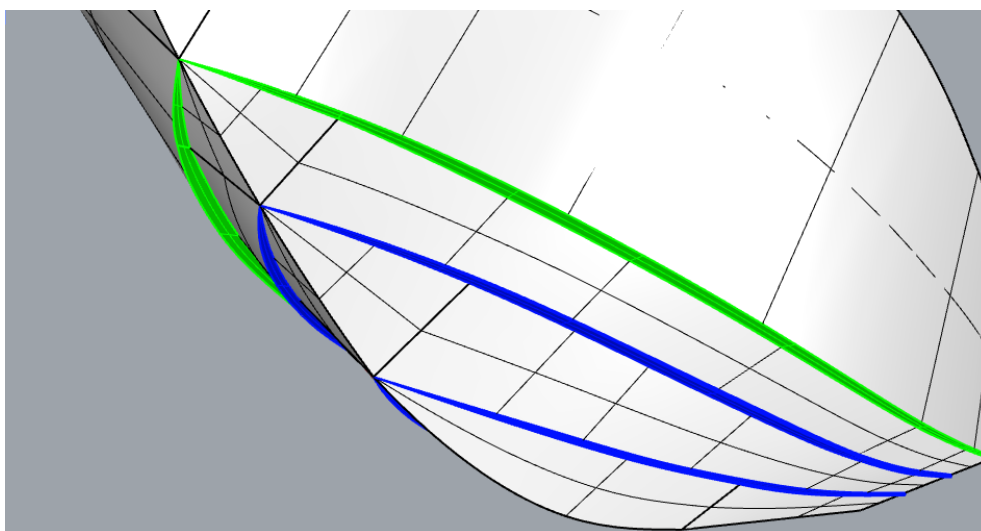

*Slika 5.10. Brizgobrani i uzdužne strujne vodilice*



## 6. PRORAČUN MASA

Prije proračuna mase i težišta plovila potrebno je saznati njihove veličine. Jedan od načina predviđanja ukupne mase plovila je uspoređivanje glavnih parametara plovila koje se projektira sa bazom podataka plovila sa sličnim parametrima. Za procjenu ukupne mase projektiranog plovila koristi se metoda I. Grubišić i E. Begovic, razvijena 2009. godine, [26]. Metoda se koristi za procjenu masa malih plovila te se temelji na sakupljenoj bazi podataka o malim plovilima. Rezultati ove metode sadrže devijacije za aluminijska plovila od 10,31% dok su devijacije za plovila napravljena od plastike ojačana staklenim vlaknima 6,64%, što ovu metodu čini dovoljno preciznom za preliminarni projekt. Procjena masa se obavlja za rekreacijsko plovilo napravljena od plastike ojačana staklenim vlaknima u izvedbi sa izvanbrodskim pogonom i u izvedbi sa vodomlaznim pogonom.

Masa broda s punim kapacitetom je opisana jednadžbom 4.1 [26].

$$W_{FL} = W_{LS} + W_{DWT} \quad (4.1)$$

Pri čemu je:

$W_{FL}$  – (*engl. Weight of full load*) masa broda s punim kapacitetom

$W_{LS}$  – (*engl. Weight of light ship*) masa prazno opremljenog broda

$W_{DWT}$  – (*engl. Weight of deadweight tonnage*) masa nosivosti broda

Masa praznog opremljenog broda ( $W_{FL}$ ) je podijeljena na devet skupina koje predstavljaju strukturu i opremu praznog opremljenog broda, opisana je jednadžbom 4.2.

$$W_{LS} = W_{100} + W_{150} + W_{200} + W_{250} + W_{300} + W_{400} + W_{500} + W_{600} + W_{700} \quad (4.2)$$

Pri čemu je:

$W_{100}$  – masa oplata i strukture broda

$W_{150}$  – masa palubne kućice

$W_{200}$  – masa pogonskih uređaja

$W_{250}$  – masa opreme pogonskih uređaja

$W_{300}$  – masa električnih strojeva

$W_{400}$  – masa električne instalacije

$W_{500}$  – masa pomoćnih sistema

$W_{600}$  – masa inventara broda

$W_{700}$  – masa rekreacijske opreme

Pri računanju mase prazno opremljenog broda za skupine čije su se vrijednosti mogli preciznije odrediti nisu korištene jednadžbe metode I. Grubišić i E. Begovic, one su određene istraživanjem i primjerima na tržištu te su detaljnije opisane u nastavku.

Masa oplata i strukture broda ( $W_{100}$ ) je podijeljena na 4 glavne površine te su njihove površine opisane jednadžbama 4.2 - 4.7.

Pri čemu je:

$S_1$  – Površina dna broda

$$S_1 = 2,825 \cdot \sqrt{\Delta_{FL} \cdot L_P} \quad (4.2)$$

$$\Delta_{FL} = 6,185 \text{ t}$$

$$L_P = 5,436 \text{ m}$$

$$S_1 = 16,38 \text{ m}^2$$

$S_2$  – Površina bokova broda broda

$$S_2 = 1,09 \cdot (2 \cdot L_{OA} + B_M) \cdot (D_X - T_X) \quad (4.3)$$

$$L_{OA} = 10,5 \text{ m}$$

$$B_M = 3,2 \text{ m}$$

$$D_X = 2,05 \text{ m}$$

$$T_X = 0,63 \text{ m}$$

$$S_2 = 37,46 \text{ m}^2$$

$S_3$  – Površina palube broda

$$S_3 = 0,823 \cdot \left( \frac{L_{OA} + L_{WL}}{2} \right) \cdot B_M \quad (4.4)$$

$$L_{WL} = 9,96 \text{ m}$$

$$S_3 = 25,76 \text{ m}^2$$

$S_4$  – Površina vodonepropusnih pregrada

$$S_4 = 0,6 \cdot N_{WTB} \cdot B_M \cdot D_X \quad (4.5)$$

$$S_4 = 0$$

Masa vodonepropusnih pregrada se ne koristi u proračunu iz razloga što se vodonepropusne pregrade ne koriste na gliserima s pramčanim kokpitom..

$$S_R = S_1 + 0,73 \cdot S_2 + 0,69 \cdot S_3 + 0,65 \cdot S_4 \quad (4.6)$$

$$S_R = 61,495 \text{ m}^2$$

Pri proračunu mase oplata i strukture broda se koriste korekcijski faktori:

$f_{DIS}$  – korekcijski faktor za efekt broda sa punim kapacitetom

$$f_{DIS} = 0,7 + 2,4 \cdot \frac{\nabla}{L_{WL}^2 - 15,8} \quad (4.7)$$

$$f_{DIS} = 0,918$$

$C_{T/D}$  – korekcijski faktor za T/D omjer

$$C_{T/D} = 1,144 \cdot \left(\frac{T_X}{D_X}\right)^{0,244} \quad (4.8)$$

$$C_{T/D} = 878$$

$E_S$  – efektivna površina

$$E_S = f_{DIS} \cdot C_{T/D} \cdot S_R \quad (4.9)$$

$$E_S = 74,001 \text{ m}^2$$

$K_{FRP}$  – konstanta strukture broda napravljen od stakloplastike ojačane vlaknima

$$K_{FRP} = 0,0135 \cdot G_f \cdot S_f - 0,0034 \quad (4.9.1)$$

Na slici 6.1. su prikazani faktori oznake za namjenu plovila prema LR SSC.

Service type	$G_f$
CARGO	1,00
PASSENGER	1,00
YACHT	1,10
PATROL	1,20
PILOT	1,25
WORKBOAT	1,25

Slika 6.1. Faktori oznake za tip usluge prema LR SSC [26]

Na slici 6.2. su prikazani faktori oznake za područje plovidbe prema LR SSC.

Service area notation	Range to refuge NM	Minimal wave height $H_{1/3}$ m	$S_f$
G1	sheltered waters	0,6	0,60
G2	20	1,0	0,75
G3	150	2,0	0,85
G4	250	4,0	1,00
G5	>250	>4,0	1,20
G6	unrestricted service	>4,0	1,25

Slika 6.2. Faktori oznake za servisno područje prema LR SSC [26]

$$G_f = 1$$

$$s_f = 0,85$$

$$K_{FRP} = 0,008075$$

Masa oplate i strukture broda ( $W_{100}$ ) iznosi:

$$W_{100} = K \cdot E_S^{1,33} \quad (4.9.2)$$

$$W_{100} = 1,453 \text{ t}$$

Mase palubnih kućica ekstremno variraju o dizajnu plovila, stoga se uzimaju približno određene dimenzije prikazane na slika 6.1.

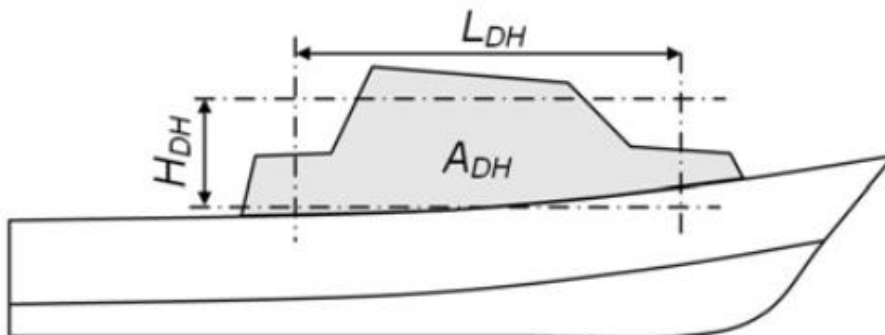

Slika 6.3. Dimenzije palubne kućice [26]

Za dimenzije palubne kućice su odabrane:

$$L_{DH} = 4 \text{ m}$$

$$H_{DH} = 1,5 \text{ m}$$

$$B_{DH} = 2,9 \text{ m}$$

$V_{DH}$  – volumen palubne kućice

$$V_{DH} = L_{DH} \cdot H_{DH} \cdot B_{DH} \quad (4.9.3)$$

$$V_{DH} = 17,4 \text{ m}^3$$

$$W_{150} = V_{DH} \cdot q_{DH} \quad (4.9.4)$$

Na slici 6.4. prikazane su volumeni, mase i gustoće materijala za palubne kućice.

VESSEL SERVICE TYPE	DECKHOUSE MATERIAL	$V_{DH}$ m <sup>3</sup>	$W_{DH}$ t	$q_{DH}$ kg/m <sup>3</sup>
FISH-heavy	Steel	42,0	3,15	76,0
FISH-light	Steel	19,7	1,26	64,0
PAX-light	Steel	16,1	0,93	57,3
PATROL	Aluminum	182,0	4,19	23,0
MY	Aluminum	139,0	3,18	22,9
PATROL	FRP	81,7	1,77	21,7

Slika 6.4. Volumeni, mase i gustoće materijala za palubne kućice [26]

$$q_{DH} = 21,7 \text{ kg/m}^3$$

Masa palubne kućice ( $W_{150}$ ) iznosi:

$$W_{150} = 0,378 \text{ t}$$

U električnu strojeve ( $W_{300}$ ) se ubraja:

- Električni panel
- Sustav za upravljanje
- Navigacijska oprema
- Radio oprema
- Sustav za zabavu
- Audio sustav
- Osvjetljene (interijer, eksterijer)
- Kaljužne pumpe
- Pumpe za vodu
- Pumpe za gorivo
- Grijači za vodu
- Hladnjak

$$W_{300} = \frac{(L \cdot B \cdot D)^{1,24}}{592} \text{ t} \quad (4.9.5)$$

$$L = 9,56 \text{ m}$$

$$B = 2,986 \text{ m}$$

$$D = 2,05 \text{ m}$$

$$W_{300} = 0,253 \text{ t}$$

U električne instalacije ( $W_{400}$ ) se ubrajaju:

- brodske baterije
- bakrena instalacija

$$W_{400} = \frac{L^{2,254}}{1887} \text{ t} \quad (4.9.6)$$

$$W_{400} = 0,086 \text{ t}$$

U rekreacijsku opremu ( $W_{700}$ ) se ubrajaju:

- Oprema za ribolov
- Oprema za ronjenje
- Oprema za vodene sportove
- Skijaški jarboli

$$W_{700} = \frac{(L \cdot B \cdot D)^{1,422}}{3000} \text{ t} \quad (4.9.7)$$

$$W_{700} = 0,069 \text{ t}$$

Vrijednosti izračunatih masa oplata i strukture broda, palubne kućice te opreme će se koristiti pri proračunu mase i težišta za obje izvedbe, odnosno za izvedbu forme sa izvanbrodskim motorom i sa vodomlaznim pogonom.

## 6.1. Masa pogonskog sustava

Pogonskih sustavi su odabrani za snagu od 490 kW određenoj prema tablici 4.11.

### 6.1.1. Izvanbrodski motor

Za izvanbrodski motor je odabran pogonski motor Suzuki DF350A, slika 6.5.



Slika 6.5. Pogonski motor Suzuki DF350A [27]

Karakteristike pogonskog motora Suzuki DF350A su prikazane na slici 6.6.

MODEL	DF350A	DF300B
RECOMMENDED TRANSOM HEIGHT (in.)	X : 25" XX : 30"	
COMPRESSION RATIO	12.0:1	10.5:1
RECOMMENDED FUEL	89 Octane	87 Octane
WEIGHT (lbs.) <sup>1)</sup>	X : 727 Lbs XX : 747 Lbs	
ENGINE TYPE	V6 - 55° DOHC 24-Valve	
Valve Train Drive	Chain with Variable Valve Timing	
FUEL DELIVERY SYSTEM	Electronic Fuel Injection with Dual Injectors Per Cylinder	
NO. OF CYLINDERS	6	
PISTON DISPLACEMENT cu.in. (cm <sup>3</sup> )	267.9 (4,390)	
BORE x STROKE in. (mm)	3.74 (98) x 3.82 (97)	
MAXIMUM OUTPUT (HP)	350	300
FULL THROTTLE OPERATING RANGE rpm	5,700 - 6,300	5,300 - 6,300
STEERING	Remote	
OIL PAN CAPACITY U.S./Imp. qt. (ℓ)	8.5 (8.0)	
IGNITION SYSTEM	Fully-transistorized	
ALTERNATOR	12V 54A	
ENGINE MOUNTING	Shear Mount	
TRIM METHOD	Power Trim and Tilt	
GEAR RATIO	2.29:1	
GEAR SHIFT	F-N-R (Drive-by-Wire)	
EXHAUST	Through Prop Hub Exhaust	
PROPELLER SELECTION (Pitch) <sup>2)</sup> All propellers are the 3-blade type	FRONT: 3x15 1/2x19.5-31.5 REAR: 3x15 1/2x19.5-31.5	

Slika 6.6. Karakteristike pogonskog motora Suzuki DF350A [27]

## 6.1.2. Vodomlazni pogonski sustav

Za vodomlazni pogonski sustav je odabran pogonski motor BUKH VGT 350, slika 6.7.



Slika 6.7. Pogonski motor BUKH VGT 350 [28]

Karakteristike pogonskog motora BUKH VGT 350 su prikazane na slici 6.8.

VGT 350 Specifications			
Model	MD-VGT32	Charge air cooling	Air to water
Number of cyl	8	Engine crankcase vent syst	Closed
Bore and stroke mm	103/98	Max crankcase press kPa	0.5
Displacement L	6.6	Length mm	779
Compression ratio	16.8:1	Width mm	825
Valves per cyl	4	Height mm	973
Firing order	1-2-7-8-4-5-6-3	Weight dry kg	450
Combustion system	DI Common rail		
Engine type	V8		
Aspiration	Variable geometry turbo		

Slika 6.8. Karakteristike pogonskog motora BUKH VGT 350 [28]

Uz vodomlazni pogonski motor potrebno je odabrati i vodomlazni propulzor iz razloga što njegova masa nije zanemariva i mora se uključiti u proračun mase i težišta. Odabran je vodomlazni propulzor Thrustmaster DJ105 serije 100, slika 6.9.





Slika 6.9. Vodomlazni propulzor Thrustmaster DJ105 serije 100 [29]

Karakteristike vodomlaznog propulzora Thrustmaster DJ105 serije 100 su prikazane na slici 6.10.

		DJ100G	DJ105	DJ110	DJ120	DJ130	DJ140	DJ170HP	
Power Range kW (hp)		225 (300)	260 (350)	335 (450)	380 (510)	410 (550)	670 (900)	855 (1150)	
Max RPM		3600	3200	3055	2800	2600	2250	1975	
Max. Displacement PLANING VESSEL	Single	3.5t	4t	4.5t	6t	7t	9t	12t	
	Twin	8t	9t	10t	12t	17t	20t	26t	
Max. Displacement DISPLACING VESSEL	Single	8t	9t	10t	15t	18t	20t	30t	
	Twin	17t	20t	22t	30t	40t	45t	66t	
Weight Kg (lbs)		Dry	125 (276)	170 (375)	180 (397)	225 (496)	295 (650)	375 (826)	550 (1213)

Slika 6.10. Karakteristike vodomlaznog propulzora Thrustmaster DJ105 [29]

U masu vodomlaznog propulzora se ubraja i voda koja se za vrijeme rada vodomlaznog propulzora nalazi unutar njega, i kao takva računa se kao masa koja se nalazi na plovilu. Masa vode u jednom vodomlaznom propulzoru se određuje prema jednadžbi 8.6.

$m_{VVP}$  – masa vode u vodomlaznom propulzoru

$P_S$  – snaga vodomlaznog pogonskog motora

$$m_{VVP} = \frac{P_S^{1,271}}{8375} \quad (8.6)$$

$$P_S = 260,99 \text{ kW (350 hp)}$$

$$m_{VVP} = 0,204 \text{ t}$$

## 6.3. Masa goriva

### 6.3.1 Masa goriva izvanbrodskog motora

Masa goriva za dva izvanbrodska motora je izračunata uzevši u obzir potrošnju goriva dva Suzuki DF350 pogonska motora sa potrošnjom od 0,3807 mpl za prosječnu brzinu okretaja motora od  $3500 \text{ min}^{-1}$  te gustoćom goriva od  $730 \text{ kg/m}^3$ . Potrošnja se računa za doplov od 150 morskih milja naveden u projektnom zahtjevu. Masa tanka goriva se računa prema jednadžbama 8.4 i 8.5.

$V_G$  – Volumen goriva

$m_G$  – masa goriva

$\rho_G$  – gustoća goriva

m – morska milja

mpl – (*engl. Miles per liter*) milja po litri

$$V_G = \frac{m}{\text{mpl}} \quad (8.4)$$

$$V_G = 394,14 \text{ l}$$

$$V_G = 0,394 \text{ m}^3$$

$$m_G = V_G \cdot \rho_G \quad (8.5)$$

$$m_G = 287,714 \text{ kg}$$

Masa goriva se uvećava za projektnu rezervu od 10 %.

$$m_G = 316,485 \text{ kg}$$

Za masu goriva izvanbrodskog pogonskog sustava se uzima približna vrijednost od 320 kg

### 6.3.2. Masa goriva vodomlaznog pogonskog sustava

Masa goriva vodomlaznog pogonskog sustava je izračunata uzevši u obzir potrošnju goriva dva BUKH V8-350 pogonska motora sa potrošnjom od 0,419 mpl za prosječnu brzinu okretaja motora od  $3500 \text{ min}^{-1}$  te gustoćom goriva od  $743 \text{ kg/m}^3$ . Potrošnja se računa za doplov od 150 milja naveden u projektnom zahtjevu. Masa tanka goriva se računa prema jednadžbama 8.4 i 8.5.

$$V_G = 359,85 \text{ l}$$
$$V_G = 0,359 \text{ m}^3$$
$$m_G = 264,222 \text{ kg}$$

Masa goriva se uvećava za projektnu rezervu od 10 %.

$$m_G = 293,58 \text{ kg}$$

Za masu goriva vodomlaznog pogonskog sustava se uzima približna vrijednost od 300 kg.

#### **6.4. Masa lubrikacijskih i hidrauličnih ulja**

Mase lubrikacijskih i hidrauličkih ulja su određene prema karakteristikama pogonskih motora, slika 8.2. i slika 8.3.

$m_{lh}$  – masa lubrikacijskih i hidrauličnih ulja

$$m_{lh \text{ Izvanbrodski}} = 20 \text{ kg}$$

$$m_{lh \text{ Vodomlazni}} = 15 \text{ kg}$$

#### **6.5 Masa osoba**

Broj osoba je određen prema maksimalnom broju mogućih osoba za plovila sličnih dimenzija. Maksimalan broj iznosi 10 osoba. Masa svake osobe je jednaka i određena je prema izvornoj normi EN ISO 12217-1:2017.

$$m_{\text{Jedna osoba}} = 75 \text{ kg}$$

#### **6.6. Masa tanka svježe vode**

Masa tanka svježe vode je određena prema broju osoba te prema mogućnosti tuširanja za svaku osobu

$$m_{\text{Tanka svježe vode}} = 170 \text{ kg}$$

#### **6.6. Masa tanka crne vode**

Masa tanka crne vode je određena prema masama tankova crne vode za plovila sličnih dimenzija.

$$m_{\text{Crne vode}} = 50 \text{ kg}$$

## 6.7 Mase inventara

Mase inventara su određene istraživanjem na tržištu za plovila sličnih dimenzija te su detaljnije opisane u proračunu mase i težišta. U mase se ubrajaju:

- Tenda za zaštitu od sunca
- Stol na pramcu
- Stol na sredini palube
- Oprema za privez
- Sidro i sidreno uže
- Sidreno vitlo
- Sjedala na pramcu
- Središnja sjedala
- Vozačka sjedala
- Sjedala na krmu
- Pomoćno sjedalo
- WC i umivaonik
- Sigurnosna oprema
- Brodska ograda i rukohvati
- Palubna obloga (tikovina)
- Brodska kuhinja (wet bar)

## 6.8 Projektna rezerva

Za izvedbu sa izvanbrodskim i vodomlaznim pogonskim sustavom, iz sigurnosnih razloga je uračunata projektna rezerva koja iznosi 7,5 % mase praznog opremljenog plovila.

$m_{PR}$  – masa projektne rezerve

$$m_{PR \text{ Izvanbrodski}} = 270 \text{ kg}$$

$$m_{PR \text{ Vodomlazni}} = 325 \text{ kg}$$

## 7. RAZMJJEŠTAJ

Kako bi se saznale pozicije masa koje će se koristiti pri proračunu mase i težišta potrebno je razviti razmještaj prostora na gliseru. Razmještaj za izvedbu sa izvanbrodskim i sa vodomlaznim pogonom se razlikuje radi drugačijih pogonskih sustava. Razlike u razmješčaju radi različitih pogonskih sustava su prikazane na slikama 7.1. i 7.2. označene sa plavom bojom.

Razmještaj na gliseru za oba pogonska sustava je izrađen u programu Rhinoceros 3D.

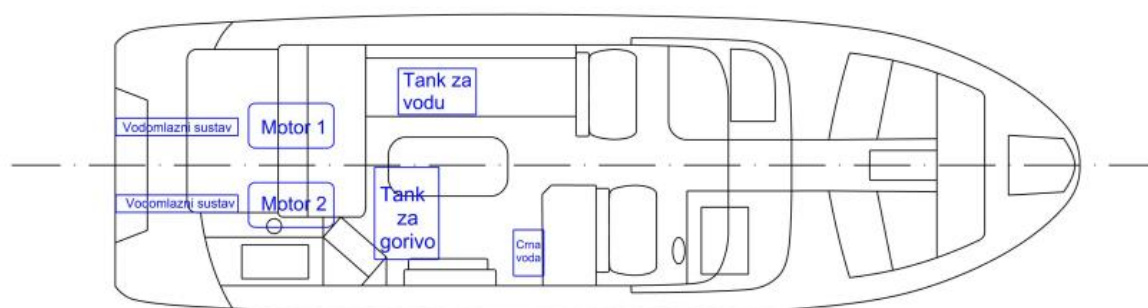

*Slika 7.1. Razmještaj glisera sa vodomlaznim pogonom*

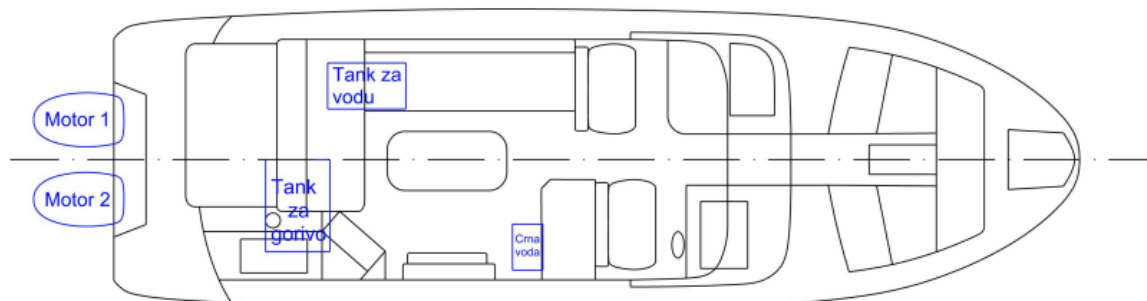

*Slika 7.2. Razmještaj glisera sa izvanbrodskim pogonom*

## 8. PRORAČUN MASE I TEŽIŠTA

Proračun mase i težišta na plovilu se izvodi kako bi se saznao položaj težišta mase broda te položaj težišta istisnine broda. Položaj težišta mase plovila i položaj težišta istisnine moraju biti u ravnoteži kako bi brod plutao uspravan i na odgovarajućoj vodnoj liniji. U stvarnosti oni su uvijek u ravnoteži jer se položaj težišta istisnine prirodno pomiče sve dok ne dođe ispod težišta mase. Ako pomicanje težišta istisnine naginje plovilo na način da je gaz na pramcu veći od gaza na krmu, brod se nalazi u pretegi. Ako pomicanje težišta istisnine naginje plovilo na način da je gaz na krmu veći od gaza na pramcu, brod se nalazi u zategi. Pri projektiranju plovila poželjno je da plovilu pri svim stanjima krcanja položaj težišta mase plovila i položaj težišta istisnine budu što bliže, odnosno da nemaju preveliku pretegu ili zategu, radi čega se proračun mase i težišta.

Položaji težišta mase plovila su opisani jednadžbama 8.1 – 8.3

LCG – (*engl. Longitudinal center of gravity*) uzdužni položaj težišta mase plovila

$$LCG = \frac{\sum m \cdot x_i}{\sum m} \quad (8.1)$$

$x_i$  – udaljenost težišta mase od krmenog zrcala

$m$  – masa

TCG – (*engl. Transverse center of gravity*) poprečan položaj težišta mase plovila

$$TCG = \frac{\sum m \cdot y_i}{\sum m} \quad (8.2)$$

$y_i$  – udaljenost težišta mase od simetrale plovila

VCG – (*engl. Vertical center of gravity*) vertikalni položaj težišta mase plovila

$$VCG = \frac{\sum m \cdot z_i}{\sum m} \quad (8.3)$$

$z_i$  – udaljenost težišta mase od kobilice plovila

Proračun mase i težišta se izvodi za tri stanja krcanja prema normi EN ISO 12217-1:2017.

$m_{LDC}$  – (*engl. Maximum load condition mass*) Stanje maksimalnog opterećenja

$m_{LA}$  – (*engl. Loaded arrival condition mass*) Stanje opterećenja pri dolasku

$m_{LA}$  – (*engl. Mass in minimum operating condition*) Stanje opterećenja pri minimalnim radnim uvjetima

Položaji težišta istisnine su određeni preko programa Rhinoceros 3D.

## 8.1. Proračun mase i težišta za dva izvanbrodska motora

Proračun mase i težišta za stanje krcanja  $m_{LDC}$  prikazana je u tablici 8.1.

Tablica 8.1. Proračun mase i težišta za stanje krcanja  $m_{LDC}$

Izvanbrodski pogon		$m_{LDC}$	$m$ (t)	$x_i$ (m)	$y_i$ (m)	$z_i$ (m)	$m \cdot x_i$ (mt)	$m \cdot y_i$ (mt)	$m \cdot z_i$ (mt)
<b>Prazan opremljen brod</b>									
<b>Masa trupa</b>									
Oplata i struktura broda			1,453	4,454	0,000	0,934	6,472	0,000	1,357
Nadgrađe			0,378	4,350	0,000	2,800	1,644	0,000	1,058
<b>Masa pogonskog uređaja</b>									
Izvanbrodski motor 1			0,338	-0,500	-0,500	1,200	-0,169	-0,169	0,406
Izvanbrodski motor 2			0,338	-0,500	0,500	1,200	-0,169	0,169	0,406
<b>Masa opreme, inventara i pomoćnih brodskih strojeva</b>									
Električni strojevi			0,201	2,350	0,000	0,700	0,471	0,000	0,140
Električna oprema			0,069	3,400	0,000	0,850	0,235	0,000	0,059
Rekreacijska oprema			0,079	3,500	0,000	1,500	0,277	0,000	0,119
Tenda za zaštitu od sunca			0,015	4,000	0,000	3,500	0,060	0,000	0,053
Stol na pramcu			0,010	8,500	0,000	1,800	0,085	0,000	0,018
Stol na sredini palube			0,020	3,650	0,000	1,800	0,073	0,000	0,036
Oprema za privez			0,015	5,000	0,000	1,900	0,075	0,000	0,029
Sidro i sidreno užje			0,020	10,050	0,000	1,850	0,201	0,000	0,037
Sidreno vitlo			0,015	10,060	0,000	1,850	0,151	0,000	0,028
Sjedala na pramcu			0,065	8,450	0,000	1,350	0,549	0,000	0,088
Središnja sjedala			0,040	3,250	-0,445	1,250	0,130	-0,018	0,050
Vozačka sjedala			0,040	5,450	0,000	1,450	0,218	0,000	0,058
Sjedala na krmu			0,025	1,290	-0,390	1,250	0,032	-0,010	0,031
Pomoćno sjedalo			0,020	3,650	1,130	1,500	0,073	0,023	0,030
WC i umivaonik			0,025	6,550	-0,830	1,350	0,164	-0,021	0,034
Sigurnosna oprema			0,045	1,750	1,020	1,000	0,079	0,046	0,045
Brodski ograda i rukohvati			0,040	5,450	0,000	2,100	0,218	0,000	0,084
Palubna obloga (tikovina)			0,070	3,165	0,000	1,000	0,222	0,000	0,070
Brodski kuhinja (wet bar)			0,045	4,945	0,756	1,400	0,223	0,034	0,063
Projektna rezerva			0,270	3,500	0,000	1,000	0,945	0,000	0,270
$\Sigma$			3,636				12,257	0,054	4,567
<b>DWT</b>									
Tank za vodu 1			0,162	2,750	-0,800	0,850	0,444	-0,129	0,137
Tank za vodu 2			0,048	4,500	0,950	0,850	0,214	0,045	0,040
Tank za gorivo			0,304	2,000	0,500	0,800	0,608	0,152	0,243
Lubrikacijska i hidraulična ulja			0,019	-0,400	0,000	1,100	-0,008	0,000	0,021
Hrana i piće			0,033	4,945	0,756	1,400	0,164	0,025	0,047
Osoba 1			0,075	1,450	-0,315	1,750	0,109	-0,024	0,131
Osoba 2			0,075	2,400	-0,130	1,750	0,180	-0,010	0,131
Osoba 3			0,075	2,400	-0,850	1,750	0,180	-0,064	0,131

Osoba 4			0,075	3,500	-0,820	1,750	0,263	-0,062	0,131
Osoba 5			0,075	3,650	1,120	1,750	0,274	0,084	0,131
Osoba 6			0,075	4,450	-0,820	1,750	0,334	-0,062	0,131
Osoba 7			0,075	5,400	-0,750	1,750	0,405	-0,056	0,131
Osoba 8			0,075	5,600	0,750	1,750	0,420	0,056	0,131
Osoba 9			0,075	8,400	0,690	1,750	0,630	0,052	0,131
Osoba 10			0,075	8,400	-0,690	1,750	0,630	-0,052	0,131
Teret			0,025	8,650	0,000	1,000	0,216	0,000	0,025
Teret			0,225	3,000	-0,440	1,000	0,675	-0,099	0,225
$\Sigma$			1,56525				5,738	-0,142	2,051

Proračun mase i težišta za stanje krcanja  $m_{LA}$  prikazana je u tablici 8.2.

Tablica 8.2. Proračun mase i težišta za stanje krcanja  $m_{LA}$

Izvanbrodski pogon		$m_{LA}$	m (t)	$x_i$ (m)	$y_i$ (m)	$z_i$ (m)	$m \cdot x_i$ (mt)	$m \cdot y_i$ (mt)	$m \cdot z_i$ (mt)
<b>Prazan opremljen brod</b>									
<b>Masa trupa</b>									
Oplata i struktura broda			1,453	4,454	0,000	0,934	6,472	0,000	1,357
Nadgrađe			0,378	4,350	0,000	2,800	1,644	0,000	1,058
<b>Masa pogonskog uređaja</b>									
Izvanbrodski motor 1			0,338	-0,500	-0,500	1,200	-0,169	-0,169	0,406
Izvanbrodski motor 2			0,338	-0,500	0,500	1,200	-0,169	0,169	0,406
<b>Masa opreme, inventara i pomoćnih brodskih strojeva</b>									
Električni strojevi			0,201	2,350	0,000	0,700	0,471	0,000	0,140
Električna oprema			0,069	3,400	0,000	0,850	0,235	0,000	0,059
Rekreacijska oprema			0,079	3,500	0,000	1,500	0,277	0,000	0,119
Tenda za zaštitu od sunca			0,015	4,000	0,000	3,500	0,060	0,000	0,053
Stol na pramcu			0,010	8,500	0,000	1,800	0,085	0,000	0,018
Stol na sredini palube			0,020	3,650	0,000	1,800	0,073	0,000	0,036
Oprema za privez			0,015	5,000	0,000	1,900	0,075	0,000	0,029
Sidro i sidreno užje			0,020	10,050	0,000	1,850	0,201	0,000	0,037
Sidreno vitlo			0,015	10,060	0,000	1,850	0,151	0,000	0,028
Sjedala na pramcu			0,065	8,450	0,000	1,350	0,549	0,000	0,088
Središnja sjedala			0,040	3,250	-0,445	1,250	0,130	-0,018	0,050
Vozačka sjedala			0,040	5,450	0,000	1,450	0,218	0,000	0,058
Sjedala na krmi			0,025	1,290	-0,390	1,250	0,032	-0,010	0,031
Pomoćno sjedalo			0,020	3,650	1,130	1,500	0,073	0,023	0,030
WC i umivaonik			0,025	6,550	-0,830	1,350	0,164	-0,021	0,034
Sigurnosna oprema			0,045	1,750	1,020	1,000	0,079	0,046	0,045
Brodsko ograda i rukohvati			0,040	5,450	0,000	2,100	0,218	0,000	0,084
Palubna obloga (tikovina)			0,070	3,165	0,000	1,000	0,222	0,000	0,070
Brodsko kuhinja (wet bar)			0,045	4,945	0,756	1,400	0,223	0,034	0,063
Projektna rezerva			0,270	3,500	0,000	1,000	0,945	0,000	0,270
$\Sigma$			3,636				12,257	0,054	4,567
<b>DWT</b>									



Tank za vodu 1			0,026	2,750	-0,800	0,850	0,070	-0,020	0,022
Tank za vodu 2			0,008	4,500	0,950	0,850	0,034	0,007	0,006
Tank za gorivo			0,048	2,000	0,500	0,800	0,096	0,024	0,038
Lubrikacijska i hidraulična ulja			0,003	-0,400	0,000	1,100	-0,001	0,000	0,003
Hrana i piće			0,004	4,945	0,756	1,400	0,017	0,003	0,005
Osoba 1			0,075	1,450	-0,315	1,750	0,109	-0,024	0,131
Osoba 2			0,075	2,400	-0,130	1,750	0,180	-0,010	0,131
Osoba 3			0,075	2,400	-0,850	1,750	0,180	-0,064	0,131
Osoba 4			0,075	3,500	-0,820	1,750	0,263	-0,062	0,131
Osoba 5			0,075	3,650	1,120	1,750	0,274	0,084	0,131
Osoba 6			0,075	4,450	-0,820	1,750	0,334	-0,062	0,131
Osoba 7			0,075	5,400	-0,750	1,750	0,405	-0,056	0,131
Osoba 8			0,075	5,600	0,750	1,750	0,420	0,056	0,131
Osoba 9			0,075	8,400	0,690	1,750	0,630	0,052	0,131
Osoba 10			0,075	8,400	-0,690	1,750	0,630	-0,052	0,131
Teret			0,025	8,650	0,000	1,000	0,216	0,000	0,025
Teret			0,225	3,000	-0,440	1,000	0,675	-0,099	0,225
Σ			1,089				4,531	-0,222	1,637

Proračun mase i težišta za stanje krcanja  $m_{MO}$  prikazana je u tablici 8.5.

Tablica 8.5 Proračun mase i težišta za stanje krcanja  $m_{MO}$

Izvanbrodski pogon		$m_{MO}$	$m$ (t)	$x_i$ (m)	$y_i$ (m)	$z_i$ (m)	$m \cdot x_i$ (mt)	$m \cdot y_i$ (mt)	$m \cdot z_i$ (mt)
<b>Prazan opremljen brod</b>									
<b>Masa trupa</b>									
Oplata i struktura broda			1,453	4,454	0,000	0,934	6,472	0,000	1,357
Nadgrađe			0,378	4,350	0,000	2,800	1,644	0,000	1,058
<b>Masa pogonskog uređaja</b>									
Izvanbrodski motor 1			0,338	-0,500	-0,500	1,200	-0,169	-0,169	0,406
Izvanbrodski motor 2			0,338	-0,500	0,500	1,200	-0,169	0,169	0,406
<b>Masa opreme, inventara i pomoćnih brodskih strojeva</b>									
Električni strojevi			0,201	2,350	0,000	0,700	0,471	0,000	0,140
Električna oprema			0,069	3,400	0,000	0,850	0,235	0,000	0,059
Rekreacijska oprema			0,079	3,500	0,000	1,500	0,277	0,000	0,119
Tenda za zaštitu od sunca			0,015	4,000	0,000	3,500	0,060	0,000	0,053
Stol na pramcu			0,010	8,500	0,000	1,800	0,085	0,000	0,018
Stol na sredini palube			0,020	3,650	0,000	1,800	0,073	0,000	0,036
Oprema za privez			0,015	5,000	0,000	1,900	0,075	0,000	0,029
Sidro i sidreno užje			0,020	10,050	0,000	1,850	0,201	0,000	0,037
Sidreno vitlo			0,015	10,060	0,000	1,850	0,151	0,000	0,028
Sjedala na pramcu			0,065	8,450	0,000	1,350	0,549	0,000	0,088
Središnja sjedala			0,040	3,250	-0,445	1,250	0,130	-0,018	0,050
Vozačka sjedala			0,040	5,450	0,000	1,450	0,218	0,000	0,058

Sjedala na krmi			0,025	1,290	-0,390	1,250	0,032	-0,010	0,031
Pomoćno sjedalo			0,020	3,650	1,130	1,500	0,073	0,023	0,030
WC i umivaonik			0,025	6,550	-0,830	1,350	0,164	-0,021	0,034
Sigurnosna oprema			0,045	1,750	1,020	1,000	0,079	0,046	0,045
Brodsko ograda i rukohvati			0,040	5,450	0,000	2,100	0,218	0,000	0,084
Palubna obloga (tikovina)			0,070	3,165	0,000	1,000	0,222	0,000	0,070
Brodsko kuhinja (wet bar)			0,045	4,945	0,756	1,400	0,223	0,034	0,063
Projektna rezerva			0,270	3,500	0,000	1,000	0,945	0,000	0,270
$\Sigma$			3,636				12,257	0,054	4,567
<b>DWT</b>									
Osoba 7			0,075	5,400	-0,750	1,750	0,405	-0,056	0,131
Osoba 8			0,075	5,600	0,750	1,750	0,420	0,056	0,131
Teret			0,050	1,500	-0,700	1,000	0,075	-0,035	0,050
$\Sigma$			0,200				0,900	-0,035	0,313

## 8.2 Proračun mase i težišta za vodomlazni pogonski sustav

Proračun mase i težišta za stanje krcanja  $m_{LDC}$  prikazana je u tablici 8.4.

Tablica 8.4. Proračun mase i težišta za stanje krcanja  $m_{LDC}$

Vodomlazni pogon		$m_{LDC}$	m (t)	$x_i$ (m)	$y_i$ (m)	$z_i$ (m)	$m \cdot x_i$ (mt)	$m \cdot y_i$ (mt)	$m \cdot z_i$ (mt)
<b>Prazno opremljen brod</b>									
<b>Masa trupa</b>									
Oplata i struktura broda			1,453	4,454	0,000	0,934	6,472	0,000	1,357
Nadgrađe			0,378	4,350	0,000	2,800	1,644	0,000	1,058
<b>Masa pogonskog uređaja</b>									
Unutarnji motor 1			0,450	2,000	-0,400	0,800	0,900	-0,180	0,360
Unutarnji motor 2			0,450	2,000	0,400	0,800	0,900	0,180	0,360
Vodomlazni sustav 1			0,170	0,600	-0,400	0,800	0,102	-0,068	0,136
Vodomlazni sustav 2			0,170	0,600	0,400	0,800	0,102	0,068	0,136
Voda u vodomlaznim susta			0,408	0,600	0,000	0,800	0,245	0,000	0,326
<b>Masa opreme, inventara i pomoćnih brodskih strojeva</b>									
Električni strojevi			0,201	2,350	0,000	0,700	0,471	0,000	0,140
Električna oprema			0,069	3,400	0,000	0,850	0,235	0,000	0,059
Rekreacijska oprema			0,079	5,000	0,000	1,500	0,395	0,000	0,119
Tenda za zaštitu od sunca			0,015	4,000	0,000	3,500	0,060	0,000	0,053
Stol na pramcu			0,010	8,500	0,000	1,800	0,085	0,000	0,018
Stol na sredini palube			0,020	3,650	0,000	1,800	0,073	0,000	0,036
Oprema za dokovanje			0,015	5,000	0,000	1,900	0,075	0,000	0,029
Sidro i sidreno uže			0,020	10,050	0,000	1,850	0,201	0,000	0,037
Sidreno vitlo			0,015	10,060	0,000	1,850	0,151	0,000	0,028
Sjedala na pramcu			0,065	8,450	0,000	1,350	0,549	0,000	0,088
Središnja sjedala			0,040	3,250	-0,445	1,250	0,130	-0,018	0,050

Vozačka sjedala			0,040	5,450	0,000	1,450	0,218	0,000	0,058
Sjedala na krmi			0,025	1,290	-0,390	1,250	0,032	-0,010	0,031
Pomoćno sjedalo			0,020	3,650	1,130	1,500	0,073	0,023	0,030
WC i umivaonik			0,025	6,550	-0,830	1,350	0,164	-0,021	0,034
Sigurnosna oprema			0,045	1,750	1,020	1,000	0,079	0,046	0,045
Brodaska ograda i rukohvati			0,040	5,450	0,000	2,100	0,218	0,000	0,084
Palubna obloga (tikovina)			0,070	3,165	0,000	1,000	0,222	0,000	0,070
Brodaska kuhinja (wet bar)			0,045	4,945	0,756	1,400	0,223	0,034	0,063
Projektna rezerva			0,325	3,500	0,000	1,000	1,138	0,000	0,325
$\Sigma$			4,663				15,155	0,054	5,129
<b>DWT</b>									
Tank za vodu 1			0,162	3,500	-0,800	0,850	0,565	-0,129	0,137
Tank za vodu 3			0,048	4,500	0,950	0,850	0,214	0,045	0,040
Tank za gorivo			0,285	3,000	0,500	0,800	0,855	0,143	0,228
Lubrikacijska i hidraulična ulja			0,014	-0,400	0,000	1,100	-0,006	0,000	0,016
Hrana i piće			0,033	4,945	0,756	1,400	0,164	0,025	0,047
Osoba 1			0,075	1,450	-0,315	1,750	0,109	-0,024	0,131
Osoba 2			0,075	2,400	-0,130	1,750	0,180	-0,010	0,131
Osoba 3			0,075	2,400	-0,850	1,750	0,180	-0,064	0,131
Osoba 4			0,075	3,500	-0,820	1,750	0,263	-0,062	0,131
Osoba 5			0,075	3,650	1,120	1,750	0,274	0,084	0,131
Osoba 6			0,075	4,450	-0,820	1,750	0,334	-0,062	0,131
Osoba 7			0,075	5,400	-0,750	1,750	0,405	-0,056	0,131
Osoba 8			0,075	5,600	0,750	1,750	0,420	0,056	0,131
Osoba 9			0,075	8,400	0,690	1,750	0,630	0,052	0,131
Osoba 10			0,075	8,400	-0,690	1,750	0,630	-0,052	0,131
Teret			0,025	8,650	0,000	1,000	0,216	0,000	0,025
Teret			0,225	3,000	-0,440	1,000	0,675	-0,099	0,225
$\Sigma$			1,542				6,108	-0,152	2,030

Proračun mase i težišta za stanje krcanja  $m_{LA}$  prikazana je u tablici 8.5.

Tablica 8.5. Proračun mase i težišta za stanje krcanja  $m_{LA}$

Vodomlazni pogon		$m_{LA}$	$m$ (t)	$x_i$ (m)	$y_i$ (m)	$z_i$ (m)	$m \cdot x_i$ (mt)	$m \cdot y_i$ (mt)	$m \cdot z_i$ (mt)
<b>Prazno opremljen brod</b>									
<b>Masa trupa</b>									
Oplata i struktura broda			1,453	4,454	0,000	0,934	6,472	0,000	1,357
Nadgrađe			0,378	4,350	0,000	2,800	1,644	0,000	1,058
<b>Masa pogonskog uređaja</b>									
Unutarnji motor 1			0,450	2,000	-0,400	0,800	0,900	-0,180	0,360
Unutarnji motor 2			0,450	2,000	0,400	0,800	0,900	0,180	0,360
Vodomlazni sustav 1			0,170	0,600	-0,400	0,800	0,102	-0,068	0,136
Vodomlazni sustav 2			0,170	0,600	0,400	0,800	0,102	0,068	0,136
Voda u vodomlaznim susta			0,408	0,600	0,000	0,800	0,245	0,000	0,326

<b>Masa opreme, inventara i pomoćnih brodskih strojeva</b>									
Električni strojevi			0,201	2,350	0,000	0,700	0,471	0,000	0,140
Električna oprema			0,069	3,400	0,000	0,850	0,235	0,000	0,059
Rekreacijska oprema			0,079	5,000	0,000	1,500	0,395	0,000	0,119
Tenda za zaštitu od sunca			0,015	4,000	0,000	3,500	0,060	0,000	0,053
Stol na pramcu			0,010	8,500	0,000	1,800	0,085	0,000	0,018
Stol na sredini palube			0,020	3,650	0,000	1,800	0,073	0,000	0,036
Oprema za dokovanje			0,015	5,000	0,000	1,900	0,075	0,000	0,029
Sidro i sidreno užje			0,020	10,050	0,000	1,850	0,201	0,000	0,037
Sidreno vitlo			0,015	10,060	0,000	1,850	0,151	0,000	0,028
Sjedala na pramcu			0,065	8,450	0,000	1,350	0,549	0,000	0,088
Središnja sjedala			0,040	3,250	-0,445	1,250	0,130	-0,018	0,050
Vozačka sjedala			0,040	5,450	0,000	1,450	0,218	0,000	0,058
Sjedala na krmi			0,025	1,290	-0,390	1,250	0,032	-0,010	0,031
Pomoćno sjedalo			0,020	3,650	1,130	1,500	0,073	0,023	0,030
WC i umivaonik			0,025	6,550	-0,830	1,350	0,164	-0,021	0,034
Sigurnosna oprema			0,045	1,750	1,020	1,000	0,079	0,046	0,045
Brodsko ograda i rukohvati			0,040	5,450	0,000	2,100	0,218	0,000	0,084
Palubna obloga (tikovina)			0,070	3,165	0,000	1,000	0,222	0,000	0,070
Brodsko kuhinja (wet bar)			0,045	4,945	0,756	1,400	0,223	0,034	0,063
Projektna rezerva			0,325	3,500	0,000	1,000	1,138	0,000	0,325
$\Sigma$			4,663				15,155	0,054	5,129
<b>DWT</b>									
Tank za vodu 1			0,026	2,750	-0,800	0,850	0,070	-0,020	0,022
Tank za vodu 3			0,008	4,500	0,950	0,850	0,034	0,007	0,006
Tank za gorivo			0,045	2,000	0,500	0,800	0,090	0,023	0,036
Lubrikacijska i hidraulična ulja			0,002	-0,400	0,000	1,100	-0,001	0,000	0,002
Hrana i piće			0,004	4,945	0,756	1,400	0,017	0,003	0,005
Osoba 1			0,075	1,450	-0,315	1,750	0,109	-0,024	0,131
Osoba 2			0,075	2,400	-0,130	1,750	0,180	-0,010	0,131
Osoba 3			0,075	2,400	-0,850	1,750	0,180	-0,064	0,131
Osoba 4			0,075	3,500	-0,820	1,750	0,263	-0,062	0,131
Osoba 5			0,075	3,650	1,120	1,750	0,274	0,084	0,131
Osoba 6			0,075	4,450	-0,820	1,750	0,334	-0,062	0,131
Osoba 7			0,075	5,400	-0,750	1,750	0,405	-0,056	0,131
Osoba 8			0,075	5,600	0,750	1,750	0,420	0,056	0,131
Osoba 9			0,075	8,400	0,690	1,750	0,630	0,052	0,131
Osoba 10			0,075	8,400	-0,690	1,750	0,630	-0,052	0,131
Teret			0,025	8,650	0,000	1,000	0,216	0,000	0,025
Teret			0,225	3,000	-0,440	1,000	0,675	-0,099	0,225
$\Sigma$			1,084				4,525	-0,223	1,634

Proračun mase i težišta za stanje krcanja  $m_{MO}$  prikazana je u tablici 8.6.

Tablica 8.6. Proračun mase i težišta za stanje krcanja  $m_{MO}$

Vodomlazni pogon		mMO	m (t)	xi (m)	yi (m)	zi (m)	m·xi (mt)	m·yi (mt)	m·zi (mt)
<b>Prazno opremljen brod</b>									
<b>Masa trupa</b>									
Oplata i struktura broda			1,453	4,454	0,000	0,934	6,472	0,000	1,357
Nadgrađe			0,378	4,350	0,000	2,800	1,644	0,000	1,058
<b>Masa pogonskog uređaja</b>									
Unutarnji motor 1			0,450	1,700	-0,800	0,800	0,765	-0,360	0,360
Unutarnji motor 2			0,450	1,700	0,800	0,800	0,765	0,360	0,360
Vodomlazni sustav 1			0,170	0,550	-0,800	0,800	0,094	-0,136	0,136
Vodomlazni sustav 2			0,170	0,550	0,800	0,800	0,094	0,136	0,136
Voda u vodomlaznim susta			0,408	0,550	0,000	0,800	0,224	0,000	0,326
<b>Masa opreme, inventara i pomoćnih brodskih strojeva</b>									
Električni strojevi			0,201	2,350	0,000	0,700	0,471	0,000	0,140
Električna oprema			0,069	3,400	0,000	0,850	0,235	0,000	0,059
Rekreacijska oprema			0,079	5,000	0,000	1,500	0,395	0,000	0,119
Tenda za zaštitu od sunca			0,015	4,000	0,000	3,500	0,060	0,000	0,053
Stol na pramcu			0,010	8,500	0,000	1,800	0,085	0,000	0,018
Stol na sredini palube			0,020	3,650	0,000	1,800	0,073	0,000	0,036
Oprema za dokovanje			0,015	5,000	0,000	1,900	0,075	0,000	0,029
Sidro i sidreno uže			0,020	10,050	0,000	1,850	0,201	0,000	0,037
Sidreno vitlo			0,015	10,060	0,000	1,850	0,151	0,000	0,028
Sjedala na pramcu			0,065	8,450	0,000	1,350	0,549	0,000	0,088
Središnja sjedala			0,040	3,250	-0,445	1,250	0,130	-0,018	0,050
Vozačka sjedala			0,040	5,450	0,000	1,450	0,218	0,000	0,058
Sjedala na krmi			0,025	1,290	-0,390	1,250	0,032	-0,010	0,031
Pomoćno sjedalo			0,020	3,650	1,130	1,500	0,073	0,023	0,030
WC i umivaonik			0,025	6,550	-0,830	1,350	0,164	-0,021	0,034
Sigurnosna oprema			0,045	1,750	1,020	1,000	0,079	0,046	0,045
Brodsko ograda i rukohvati			0,040	5,450	0,000	2,100	0,218	0,000	0,084
Palubna obloga (tikovina)			0,070	3,165	0,000	1,000	0,222	0,000	0,070
Brodsko kuhinja (wet bar)			0,045	4,945	0,756	1,400	0,223	0,034	0,063
Projektna rezerva			0,325	3,500	0,000	1,000	1,138	0,000	0,325
Σ			4,663				14,848	0,054	5,129
<b>DWT</b>									
Osoba 7			0,075	5,400	-0,750	1,750	0,405	-0,056	0,131
Osoba 8			0,075	5,600	0,750	1,750	0,420	0,056	0,131
Teret			0,050	1,500	-0,700	1,000	0,075	-0,035	0,050
Σ			0,200				0,900	-0,035	0,313

### 8.3. Položaji težišta za izvanbrodski pogonski sustav

Položaji težišta za stanje krcanja  $m_{LDC}$  su prikazani u tablici 8.7.

*Tablica 8.7. Položaji težišta za stanje krcanja  $m_{LDC}$*

$\Delta$	5,20	t
LCG	3,46	m
TCG	-0,02	m
VCG	1,27	m
GAZ	0,57	m
$\nabla$	5,07	m <sup>3</sup>
LCB	3,39	m
TCB	0,00	m
VCB	0,4	m

Položaji težišta za stanje krcanja  $m_{LA}$  su prikazani u tablici 8.8.

*Tablica 8.8. Položaji težišta za stanje krcanja  $m_{LA}$*

$\Delta$	4,72	t
LCG	3,55	m
TCG	0,01	m
VCG	1,31	m
GAZ	0,54	m
$\nabla$	4,61	m <sup>3</sup>
LCB	3,4	m
TCB	0,00	m
VCB	0,38	m

Položaji težišta za stanje krcanja  $m_{MO}$  su prikazani u tablici 8.9.

*Tablica 8.9. Položaji težišta za stanje krcanja  $m_{MO}$*

$\Delta$	3,84	t
LCG	3,43	m
TCG	0,01	m
VCG	1,27	m
GAZ	0,49	m
$\nabla$	3,74	m <sup>3</sup>
LCB	3,37	m
TCB	0,00	m
VCB	0,35	m

#### 8.4. Položaji težišta za vodmlazni pogonski sustav

Položaji težišta za stanje krcanja  $m_{LDC}$  su prikazani u tablici 8.10.

*Tablica 8.10. Položaji težišta za stanje krcanja  $m_{LDC}$*

$\Delta$	6,20	t
LCG	3,43	m
TCG	-0,02	m
VCG	1,15	m
GAZ	0,62	m
$\nabla$	6,05	m <sup>3</sup>
LCB	3,4	m
TCB	0,00	m
VCB	0,43	m

Položaji težišta za stanje krcanja  $m_{LA}$  su prikazani u tablici 8.11.

*Tablica 8.11. Položaji težišta za stanje krcanja  $m_{LA}$*

$\Delta$	5,75	t
LCG	3,42	m
TCG	0,01	m
VCG	1,18	m
GAZ	0,59	m
$\nabla$	5,61	m <sup>3</sup>
LCB	3,43	m
TCB	0,00	m
VCB	0,42	m

Položaji težišta za stanje krcanja  $m_{MO}$  su prikazani u tablici 8.12.

*Tablica 8.12. Položaji težišta za stanje krcanja  $m_{MO}$*

$\Delta$	4,86	t
LCG	3,24	m
TCG	0,00	m
ZCG	1,10	m
GAZ	0,55	m
$\nabla$	4,74	m <sup>3</sup>
LCB	3,4	m
TCB	0,00	m
ZCB	0,39	m

Prema tablicama 8.7.- 8.12. pozicije LCG-a i LCB-a za trenutnu formu plovila nisu poželjne, obje izvedbe se za većinu stanja krcanja nalaze u pretegi. Iz tog razloga odlučeno je proširiti formu na pramčanom dijelu plovila kako bi se LCB pomaknuo naprijed.

Izgleda proširenja pramčanog dijela u usporedbi sa prijašnjom formom prikazan je na slici 8.1.

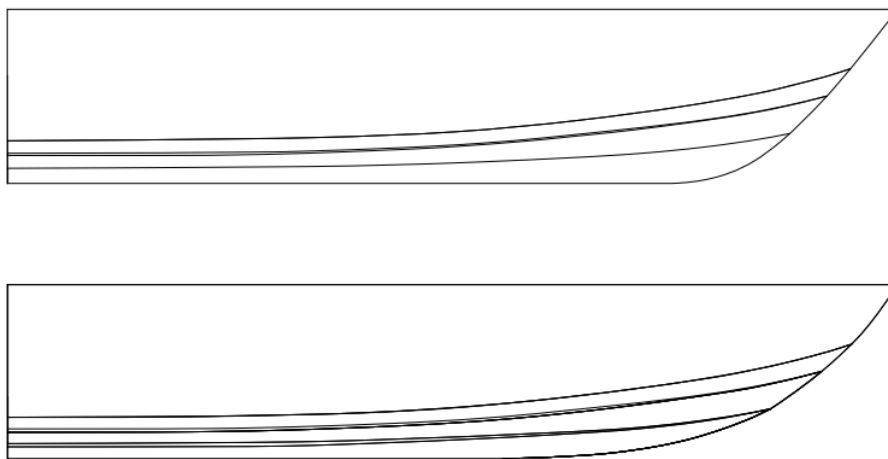

*Slika 8.1. Proširenje pramčanog dijela forme*

Na slici 8.2. prikazan je izgled proširene forme

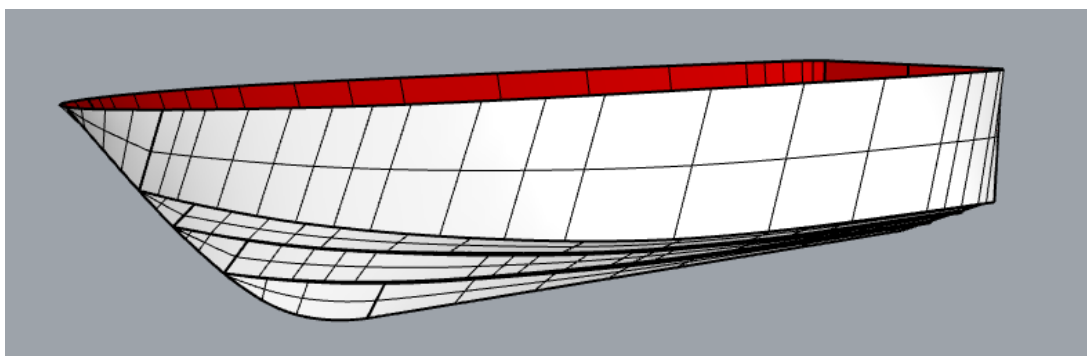

*Slika 8.2. Izgled proširene forme*

Nakon proširenja forme potrebno je ponovo napraviti proračun mase i težišta, no logično je da se promjenom forme odnosno oplata i strukture broda promijenio i položaj težišta mase trupa. LCG oplata i strukture broda prve forme prema kojem je određen položaj težišta mase se odredio prema metodi I. Grubišić i E. Begovic, jednadžba 8.4.

$X_{W100}$  – Udaljenost težišta mase oplata i strukture broda od krmenog zrcala

$L_H$  – Duljina plovila

$$\frac{X_{W100}}{L_H} = 0,4242 \quad (8.4.)$$

$$X_{W100} = 4,454 \text{ m}$$



Kako je određivanje uzdužnog položaja težišta mase oplata i strukture broda uvjetovano samo duljinom broda koja se ne mijenja, položaj težišta mase oplata i strukture broda ostaje isti.

### 8.5. Položaji težišta za izvanbrodski pogonski sustav proširene forme

Položaji težišta za stanje krcanja  $m_{LDC}$  su prikazani u tablici 8.13.

Tablica 8.13. Položaji težišta za stanje krcanja  $m_{LDC}$

$\Delta$	5,20	t
LCG	3,46	m
TCG	-0,02	m
VCG	1,27	m
GAZ	0,57	m
$\nabla$	5,07	m <sup>3</sup>
LCB	3,48	m
TCB	0,00	m
VCB	0,38	m

Položaji težišta za stanje krcanja  $m_{LA}$  su prikazani u tablici 8.14.

Tablica 8.14. Položaji težišta za stanje krcanja  $m_{LA}$

$\Delta$	4,72	t
LCG	3,55	m
TCG	0,01	m
VCG	1,31	m
GAZ	0,54	m
$\nabla$	4,61	m <sup>3</sup>
LCB	3,47	m
TCB	0,00	m
VCB	0,36	m

Položaji težišta za stanje krcanja  $m_{MO}$  su prikazani u tablici 8.15.

Tablica 8.15. Položaji težišta za stanje krcanja  $m_{MO}$

$\Delta$	3,84	t
LCG	3,43	m
TCG	0,01	m
VCG	1,27	m
GAZ	0,49	m
$\nabla$	3,74	m <sup>3</sup>
LCB	3,45	m
TCB	0,00	m
VCB	0,33	m

## 8.6. Položaji težišta za vodomlazni pogonski sustav proširene forme

Položaji težišta za stanje krcanja  $m_{LDC}$  su prikazani u tablici 8.16.

Tablica 8.16. Položaji težišta za stanje krcanja  $m_{LDC}$

$\Delta$	6,20	t
LCG	3,43	m
TCG	-0,02	m
VCG	1,15	m
GAZ	0,62	m
$\nabla$	6,05	$m^3$
LCB	3,51	m
TCB	0,00	m
VCB	0,41	m

Položaji težišta za stanje krcanja  $m_{LA}$  su prikazani u tablici 8.17.

Tablica 8.17. Položaji težišta za stanje krcanja  $m_{LA}$

$\Delta$	5,75	t
LCG	3,42	m
TCG	0,01	m
VCG	1,18	m
GAZ	0,59	m
$\nabla$	5,61	$m^3$
LCB	3,50	m
TCB	0,00	m
VCB	0,40	m

Položaji težišta za stanje krcanja  $m_{MO}$  su prikazani u tablici 8.18.

Tablica 8.18. Položaji težišta za stanje krcanja  $m_{MO}$

$\Delta$	4,86	t
LCG	3,24	m
TCG	0,00	m
ZCG	1,10	m
GAZ	0,55	m
$\nabla$	4,74	$m^3$
LCB	3,47	m
TCB	0,00	m
ZCB	0,37	m

Položaji težišta mase plovila i položaji težišta istisnine proširene forme su povoljniji za brzu plovidbu naspram položaja težišta prijašnje forme. Nova forma plovila se usvaja i s njom se kreće dalje u proračun.

## 9. PLISKANJE

Kada plovilo ubrzava dolazi do pojave hidrodinamičkih sila koje pramčani dio plovila podižu iznad vode. Podizanjem plovila iznad vode smanjuje se uronjeni volumen, što naposljetku smanjuje otpor plovila i povećava efikasnost i brzinu plovidbe. Pojava gdje hidrodinamički uzgon prevladava nad hidrostatičkim uzgonom naziva se glisiranjem plovila, slika 9.1.



*Slika 9.1. Glisiranje plovila [30]*

Tijekom glisiranja smanjuje se uronjeni volumen, posebno pramčanog dijela plovila čime se uzdužni položaj težišta istisnine broda pomiče prema krmi, dok se uzdužni položaj težišta mase plovila ne mijenja. Kako uzdužni položaji težišta istisnine i težišta mase plovila više nisu u istoj vertikalnoj ravnini plovilo više nije u ravnoteži, već ono što ga drži u ravnoteži je hidrodinamička sila generirana brzom plovidbom. U slučaju da se pri glisiranju uronjeni volumen toliko smanji da ga hidrodinamička sila više ne može držati u ravnoteži brod će naglo posrnuti. Posrtanjem broda povećava se uronjeni volumen, brod opet kreće glisirati i dolazi do ponavljanja cijelog procesa. Navedeno cikličko ponašanje plovila se naziva pliskanjem i najčešće se pojavljuje pri glisiranju na ravnoj i mirnoj vodi. Pliskanje plovila može plovidbu učiniti vrlo neugodnom no u slučaju da uslijed pliskanja dođe do gubitka nad kontrolom plovila može doći do oštećenja plovila pa čak i do ozljede osoba. Jedna od metoda za provjeru pliskanja plovila je metoda D.Savitsky razvijena 1964.g, [31].

Provjera za pliskanje se obavlja za vodomlazni i izvanbrodski pogon.

Prije provjere plovila na pliskanje potrebno je pronaći dinamički kut trima plovila. Dinamički kut trima plovila se pronalazi empiričkom metodom [32].

$F_{nV}$  – Freudov broj

$$F_{nV} = \frac{V}{\sqrt{g \cdot \nabla^{1/3}}} \quad (4.1)$$

$$V = 21,378 \text{ m/s}$$

$$g = 9,806 \text{ m/s}^2$$

$$\nabla_{\text{Vodmlazni}} = 6,053 \text{ m}^3$$

$$\nabla_{\text{Izvanbrodski}} = 5,073 \text{ ft}^3$$

$$F_{nV \text{ Vodmlazni}} = 10,309$$

$$F_{nV \text{ Izvanbrodski}} = 10,597$$

$C_V$  – Freudov broj na temelju širine vodne linije

$$C_V = \frac{V}{\sqrt{g \cdot b}} \quad (4.2)$$

$$b_{\text{Vodmlazni}} = 2,64 \text{ m}$$

$$b_{\text{Izvanbrodski}} = 2,59 \text{ m}$$

$$C_{V \text{ Vodmlazni}} = 4,39$$

$$C_{V \text{ Izvanbrodski}} = 4,44$$

$C_{Lb}$  – Koeficijent uzgona ekvivalentne ravne ploče

$$C_{Lb} = \frac{\rho \cdot g \cdot D_V}{0,5 \cdot \rho \cdot V^2 \cdot b^2} \quad (4.3)$$

$$\rho = 1,025 \text{ t/m}^3$$

$$C_{Lb \text{ Vodmlazni}} = 0,034$$

$$C_{Lb \text{ Izvanbrodski}} = 0,029$$

$p/b$  – omjer

$$p_{\text{Vodmlazni}} = 3,427 \text{ m}$$

$$p_{\text{Izvanbrodski}} = 3,46 \text{ m}$$

$$\frac{p}{b_{\text{Vodmlazni}}} = 1,3$$

$$\frac{p}{b_{\text{Izvanbrodski}}} = 1,34$$

Na slici 9.2. su prikazane Koelbel-ove krivulje pomoću kojih se pronalazi koeficijent  $\lambda$ .

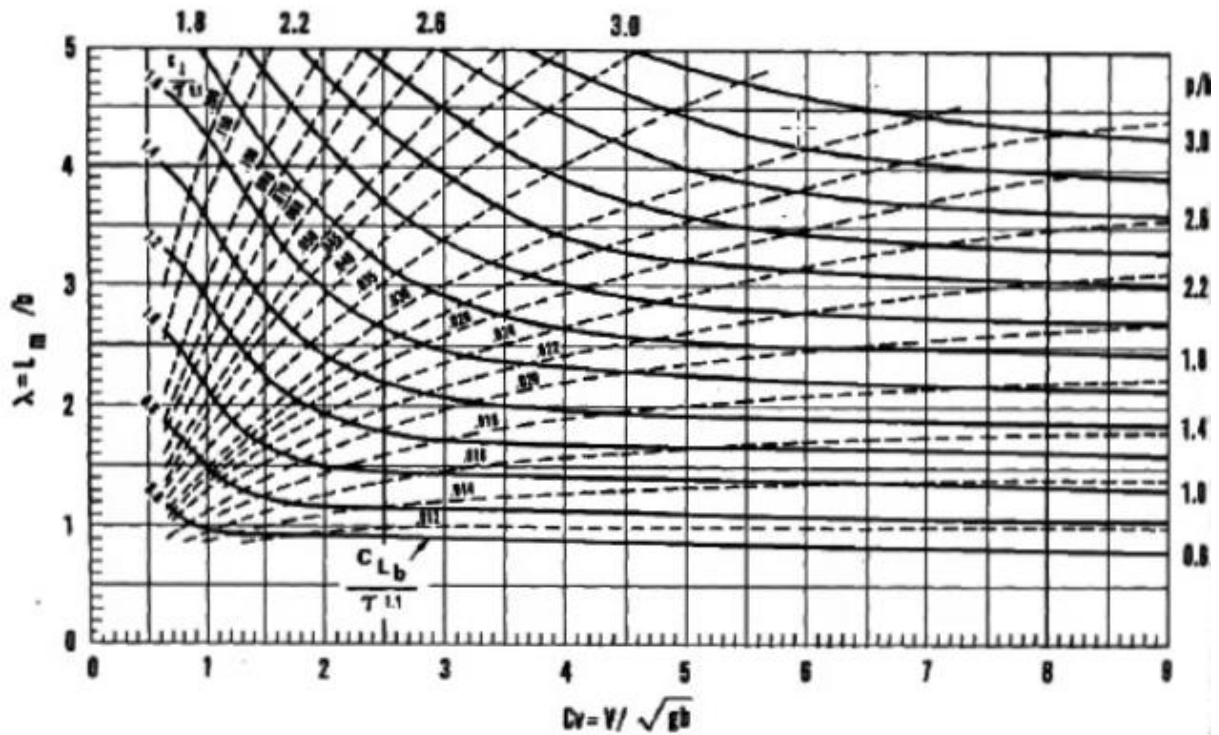

Slika 9.2. Koelbel-ove krivulje [32]

Očitano:

$$\lambda_{\text{Vodomlazni}} = 1,8$$

$$\lambda_{\text{Izvanbrodski}} = 1,9$$

Dinamički kut trima broda se zatim dobiva iz jednadžbe 4.5.

$$C_{Lb} = \tau^{1,1} \cdot \left( 0,0120 \cdot \sqrt{\lambda} + 0,0055 \cdot \frac{\lambda^{2,5}}{C_V^2} \right) \quad (4.5)$$

$$\tau_{\text{Vodomlazni}} = 1,459^\circ$$

$$\tau_{\text{Izvanbrodski}} = 1,351^\circ$$

$\sqrt{\frac{C_{Lb}}{2}}$  – vrijednosti za ulazak u dijagram

$$\sqrt{\frac{C_{Lb}}{2}}_{\text{Vodmlazni}} = 0,13$$

$$\sqrt{\frac{C_{Lb}}{2}}_{\text{Izvanbrodski}} = 0,121$$

Na slici 9.3. prema Savitsky [29] prikazane su granice za pliskanje, ako se dobivene vrijednosti nalaze ispod granica za pliskanje brod se nalazi u području stabilnog glisiranja.

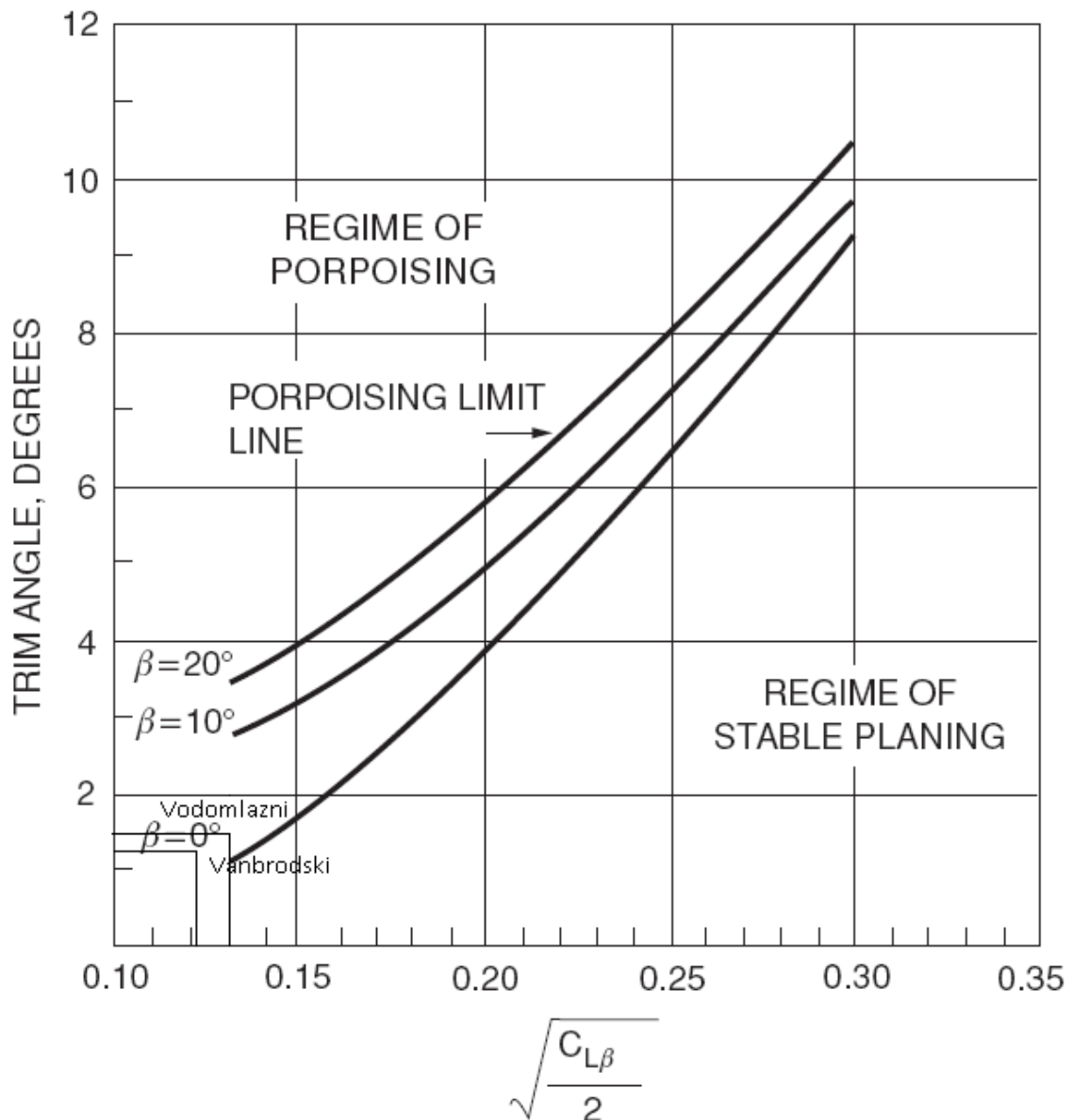

Slika 9.3. Granice za pliskanje [32]

Nakon uvrštavanja dinamičkih kutova trima i omjera  $\sqrt{\frac{C_{Lb}}{2}}$ , vodmlazna i izvanbrodska izvedba se nalaze u području stabilnog glisiranja. Tijekom brze plovidbe neće doći do pojave pliskanja.

## 10. ODABIR VODOMLAZNOG POGONSKOG SUSTAVA

### 10.1 Određivanje poriva vodomlaznog propulzora

Jedan od zahtijevanih izvedbi pogonskog sustava plovila je izvedba sa vodomlaznim pogonskim sustavom. Vodomlazni pogonski sustav se razvija metodom Donald L. Blount-a i and Robert J. Bartee-a [33].

Kako bi se odredio poriv vodomlaznog propulzora potrebno je prvo odrediti potreban poriv  $T$ . Potreban poriv se računa prema jednadžbi 10.1.

$T$  – potreban poriv

$$T = \frac{R_T}{1-t} \quad (10.1)$$

$t$  – koeficijent smanjenja poriva

Kako bi se odredio koeficijent smanjenja poriva  $t$ , potrebno je prvo odrediti odrediti Froudeov broj na bazi volumena brodske forme prema jednadžbi 10.2.

$Fr_V$  – freudov broj na bazi volumena

$$Fr_V = \frac{V}{\sqrt{g \cdot V^{1/3}}} \quad (10.2)$$

$$V = 43,5 \text{ } \check{c}v$$

$$V = 5,986 \text{ } m^3$$

$$g = 9,806 \frac{m}{s^2}$$

$$Fr_V = 10,309$$

Koeficijent smanjenja poriva  $t$  se određuje iz prema, slika 10.1.

PROPULSION CONCEPT		SPEED RANGE								
		DISPLACEMENT $F_{re} < 1$			SEMI-PLANING $1 \leq F_{re} < 2.5$			PLANING $F_{re} > 2.5$		
		$W_T$	$t$	$\eta_h$	$W_T$	$t$	$\eta_h$	$W_T$	$t$	$\eta_h$
PROPELLER ON INCLINED SHAFT	6 DEG SHAFT	0.01 TO -0.02	0.01	0.97 TO 1.01	0 TO 0.04	0.01 TO 0.02	0.97 TO 1.01	0 TO -0.10	0.03	0.97 TO 1.01
	12 DEG SHAFT	0.02 TO -0.02	0.05	0.97 TO 1.01	0.04 TO -0.05	0.05 TO 0.07	0.97 TO 1.01	0.03 TO -0.05	0.07 TO 0.11	0.97 TO 1.01
PROPELLER IN TUNNEL	40% D	-0.03	0.10	0.92	0.02 TO -0.03	0.07 TO 0.10	0.93 TO 0.90	0.03	0.03 TO 0.07	0.88 TO 0.90
	65% D	-0.03	0.12	0.92	0 TO 0.05	0.10 TO 0.12	0.93 TO 0.90	0.04 TO 0.05	0.08 TO 0.10	0.88 TO 0.90
OUTBOARD & OUTDRIVE PROPELLER		0.03	0	0.97 TO 1.01	0.03	0	0.97 TO 1.01	0.03	0	0.97 TO 1.01
PARTIALLY SUBMERGED PROPELLER		0	0	0.97 TO 1.01	0	0	0.97 TO 0.98	0	0	0.97 TO 1.01
FLUSH INLET WATERJET		0 TO 0.02	0.05 TO 0.08	0.99	0.02 TO 0.04	0.05	0.99	0.05	-0.02 TO -0.07	0.99
TRACTOR PROPELLER		0	0 TO 0.05	1.00	0	0 TO 0.05	1.00	0	0 TO 0.05	1.00
PUSHER PROPELLER (UNDER HULL)		0.05 TO 0.07	0.05 TO 0.07	0.97 TO 1.01	0.05 TO 0.07	0.05 TO 0.07	0.97 TO 1.01	0.05 TO 0.07	0.05	0.97 TO 1.01

Slika 10.1. Tablica propulzija-trup interaktivnih faktora [33]

Koeficijent smanjenja poriva  $t$  odabrana je srednjom vrijednošću navedenih koeficijenata u tablici propulzija-trup interaktivnih faktora, slika 10.1.

$$t = \frac{-0,02 + (-0,07)}{2}$$

$$t = -0,045$$

Dalje je potrebno odrediti ukupni otpor  $R_T$ . Ukupni otpor je dobiven analizom golog trupa (bez privjesaka) u programu Maxsurf. Dio Maxsurf programskog paketa pomoću kojeg se može odrediti otpor naziva se Maxsurf Resistance. Za proračun otpora odabrana je metoda najpogodnija za glisiranje, „Savitsky planing“.

Odabrani raspon brzina za računanje otpora iznosi 26- 51 čv. Pri računanju otpora korišteni su gaz i LCG izračunati u proračunu mase i težišta.

Tablica 10.1. Otpor forme i izračunati poriv

V (čv)	V (m/s)	Rt/kN	t	T(ukupni), kN	T(1motor),kN
26,000	13,376	11,200	-0,045	10,718	5,359
26,625	13,697	11,200	-0,045	10,718	5,359
27,250	14,019	11,100	-0,045	10,622	5,311
27,875	14,340	11,000	-0,045	10,526	5,263
28,500	14,662	11,000	-0,045	10,526	5,263
29,125	14,983	11,000	-0,045	10,526	5,263
29,750	15,305	10,900	-0,045	10,431	5,215
30,375	15,626	10,900	-0,045	10,431	5,215
31,000	15,948	10,900	-0,045	10,431	5,215
31,625	16,269	10,900	-0,045	10,431	5,215
32,250	16,591	10,900	-0,045	10,431	5,215
32,875	16,912	11,000	-0,045	10,526	5,263



33,500	17,234	11,000	-0,045	10,526	5,263
34,125	17,555	11,000	-0,045	10,526	5,263
34,750	17,877	11,100	-0,045	10,622	5,311
35,375	18,198	11,100	-0,045	10,622	5,311
36,000	18,520	11,200	-0,045	10,718	5,359
36,625	18,842	11,200	-0,045	10,718	5,359
37,250	19,163	11,300	-0,045	10,813	5,407
37,875	19,485	11,400	-0,045	10,909	5,455
38,500	19,806	11,500	-0,045	11,005	5,502
39,125	20,128	11,600	-0,045	11,100	5,550
39,750	20,449	11,700	-0,045	11,196	5,598
40,375	20,771	11,800	-0,045	11,292	5,646
41,000	21,092	11,900	-0,045	11,388	5,694
41,625	21,414	12,000	-0,045	11,483	5,742
42,250	21,735	12,100	-0,045	11,579	5,789
42,875	22,057	12,200	-0,045	11,675	5,837
43,500	22,378	12,400	-0,045	11,866	5,933
44,125	22,700	12,500	-0,045	11,962	5,981
44,750	23,021	12,700	-0,045	12,153	6,077
45,375	23,343	12,800	-0,045	12,249	6,124
46,000	23,664	13,000	-0,045	12,440	6,220
46,625	23,986	13,100	-0,045	12,536	6,268
47,250	24,308	13,300	-0,045	12,727	6,364
47,875	24,629	13,400	-0,045	12,823	6,411
48,500	24,951	13,600	-0,045	13,014	6,507
49,125	25,272	13,800	-0,045	13,206	6,603
49,750	25,594	14,000	-0,045	13,397	6,699
50,375	25,915	14,100	-0,045	13,493	6,746
51,000	26,237	14,300	-0,045	13,684	6,842

Na slici 10.2. je prikazan dijagram potrebnog poriva.

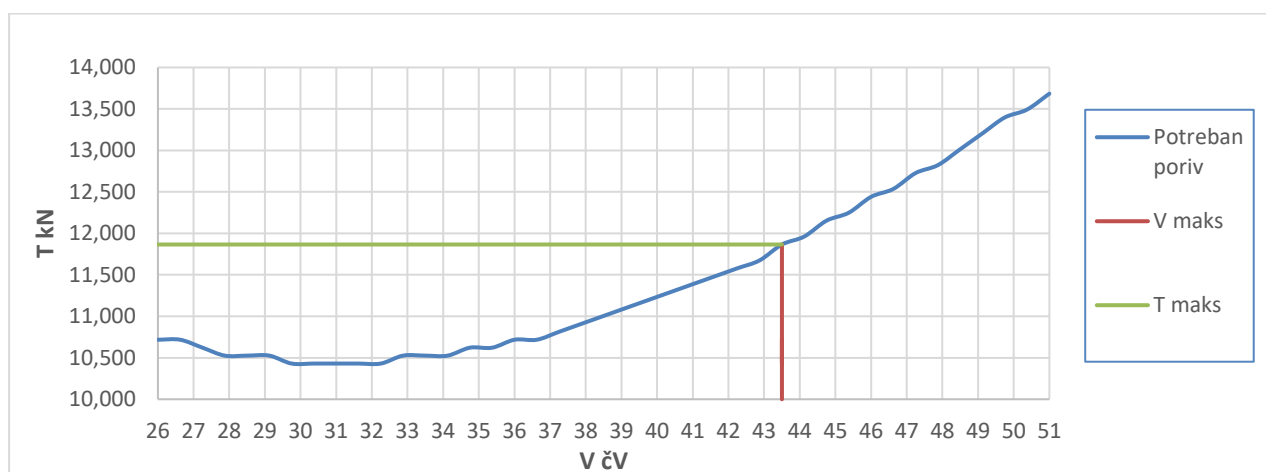

Slika 10.2. Dijagram poriva brodske forme

U tablici 4.11. za brzinu od 43,5 čv određena je snaga od 490 kW. Poriv vodomlaznog propulzora će se određivati za snagu dva motora približne snage 490 kW. Snaga motora iznosi 521,98 kW (700 hp). Kako izvedba vodomlaznog pogonskog sustava koristi dva pogonska motora, snaga jednog pogonskog motora iznosi 260,99 kW.

Kako bi se odredio poriv vodomlaznog propulzora potrebno je odrediti promjer kućišta impelera  $D_I$  prema jednadžbi 10.3 [33].

$D_I$  – promjer kućišta impelera

$$D_I = \frac{P_S \cdot (1,241 - (0,1267) \cdot V^{\frac{1}{2}})^{\frac{1}{2}}}{12} \quad (10.3)$$

$$P_S = 350 \text{ HP}$$

$$V = 43,5 \text{ čv}$$

Dalje je potrebno odrediti izlaznu brzinu vode  $V_{JB}$  prema jednadžbi 10.4.

$V_{JB}$  – izlazna brzina vode

$$V_{JB} = (1611,7 \cdot P_S^{1,0556}) / (\rho_{MV} \cdot D_I)^{1/3} \quad (10.4)$$

$$\rho_{MV} = 1025 \text{ kg/m}^3$$

Poriv vodomlaznog propulzora  $T_{VP}$  se zatim računa prema jednadžbi 10.5.

$T_{VP}$  – poriv vodomlaznog propulzora

$$T_{VP} = \rho_{MV} \cdot (0,385) \cdot D_I^2 \cdot V_{JB}^2 \cdot 1 + \left[ \frac{V}{V_{JB}} \cdot \left( \frac{V_{JB}}{V} + 1 \right)^{-1,737} - \frac{V}{V_{JB}} \right] \quad (10.5)$$

Rezultati proračuna poriva vodomlaznog propulzora su prikazani u tablici 10.2.

*Tablica 10.2 Proračun poriva vodomlaznog propulzora*

V (čv)	V (m/s)	V (ft/s)	Ps (kW)	Ps (HP)	D1 (ft)	D1 (m)	VJB (m/s)	TVP (lb)	TVP (kN)	2TVP (kN)
26,000	13,376	43,883	260,990	350	0,615	0,187	27,904	2477,186	10,900	21,799
26,625	13,697	44,938	260,990	350	0,615	0,187	27,904	2443,743	10,752	21,505
27,250	14,019	45,993	260,990	350	0,615	0,187	27,904	2410,655	10,607	21,214
27,875	14,340	47,048	260,990	350	0,615	0,187	27,904	2377,916	10,463	20,926
28,500	14,662	48,103	260,990	350	0,615	0,187	27,904	2345,522	10,320	20,641
29,125	14,983	49,157	260,990	350	0,615	0,187	27,904	2313,470	10,179	20,359
29,750	15,305	50,212	260,990	350	0,615	0,187	27,904	2281,755	10,040	20,079
30,375	15,626	51,267	260,990	350	0,615	0,187	27,904	2250,373	9,902	19,803
31,000	15,948	52,322	260,990	350	0,615	0,187	27,904	2219,320	9,765	19,530

31,625	16,269	53,377	260,990	350	0,615	0,187	27,904	2188,593	9,630	19,260
32,250	16,591	54,432	260,990	350	0,615	0,187	27,904	2158,185	9,496	18,992
32,875	16,912	55,487	260,990	350	0,615	0,187	27,904	2128,095	9,364	18,727
33,500	17,234	56,542	260,990	350	0,615	0,187	27,904	2098,318	9,233	18,465
34,125	17,555	57,597	260,990	350	0,615	0,187	27,904	2068,849	9,103	18,206
34,750	17,877	58,651	260,990	350	0,615	0,187	27,904	2039,686	8,975	17,949
35,375	18,198	59,706	260,990	350	0,615	0,187	27,904	2010,823	8,848	17,695
36,000	18,520	60,761	260,990	350	0,615	0,187	27,904	1982,257	8,722	17,444
36,625	18,842	61,816	260,990	350	0,615	0,187	27,904	1953,985	8,598	17,195
37,250	19,163	62,871	260,990	350	0,615	0,187	27,904	1926,001	8,474	16,949
37,875	19,485	63,926	260,990	350	0,615	0,187	27,904	1898,304	8,353	16,705
38,500	19,806	64,981	260,990	350	0,615	0,187	27,904	1870,888	8,232	16,464
39,125	20,128	66,036	260,990	350	0,615	0,187	27,904	1843,751	8,113	16,225
39,750	20,449	67,090	260,990	350	0,615	0,187	27,904	1816,888	7,994	15,989
40,375	20,771	68,145	260,990	350	0,615	0,187	27,904	1790,296	7,877	15,755
41,000	21,092	69,200	260,990	350	0,615	0,187	27,904	1763,971	7,761	15,523
41,625	21,414	70,255	260,990	350	0,615	0,187	27,904	1737,910	7,647	15,294
42,250	21,735	71,310	260,990	350	0,615	0,187	27,904	1712,109	7,533	15,067
42,875	22,057	72,365	260,990	350	0,615	0,187	27,904	1686,565	7,421	14,842
43,500	22,378	73,420	260,990	350	0,615	0,187	27,904	1661,275	7,310	14,619
44,125	22,700	74,475	260,990	350	0,615	0,187	27,904	1636,234	7,199	14,399
44,750	23,021	75,529	260,990	350	0,615	0,187	27,904	1611,441	7,090	14,181
45,375	23,343	76,584	260,990	350	0,615	0,187	27,904	1586,891	6,982	13,965
46,000	23,664	77,639	260,990	350	0,615	0,187	27,904	1562,581	6,875	13,751
46,625	23,986	78,694	260,990	350	0,615	0,187	27,904	1538,509	6,769	13,539
47,250	24,308	79,749	260,990	350	0,615	0,187	27,904	1514,671	6,665	13,329
47,875	24,629	80,804	260,990	350	0,615	0,187	27,904	1491,063	6,561	13,121
48,500	24,951	81,859	260,990	350	0,615	0,187	27,904	1467,684	6,458	12,916
49,125	25,272	82,914	260,990	350	0,615	0,187	27,904	1444,529	6,356	12,712
49,750	25,594	83,969	260,990	350	0,615	0,187	27,904	1421,596	6,255	12,510
50,375	25,915	85,023	260,990	350	0,615	0,187	27,904	1398,883	6,155	12,310
51,000	26,237	86,078	260,990	350	0,615	0,187	27,904	1376,385	6,056	12,112

Na slici 10.3. je prikazan dijagram poriva vodomlaznih propulzora T<sub>VP</sub>.

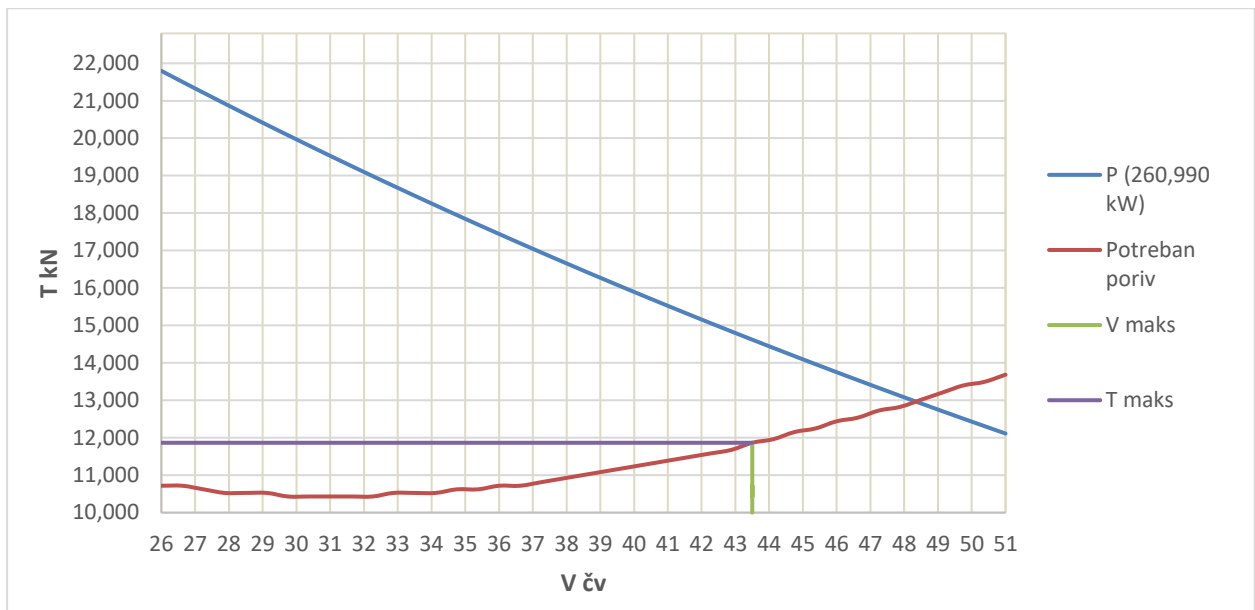

Slika 10.3. Dijagram vodomlaznih propulzora  $T_{VP}$

Sa dijagrama poriva prikazanim na slici 10.3., vidi se da pretpostavljena snaga daje prevelik poriv za postizanje brzine od 43,5 čv prevelika.

Kako bi se postigla potrebna snaga motora, odnosno dovoljan poriv vodomlaznih propulzora za brzinu od 43,5 čv iteracijskim putem se u jednadžbe (10.3) i (10.4) ubacuje sve manja vrijednost snage motora  $P_s$ . Poriv vodomlaznih propulzora koji je potrebno postići je poriv brodske forme koji iznosi 11,866 kN za brzinu od 43,5 čv, tablica 10.2.

Porivi vodomlaznih propulzora dobiveni iteracijskim smanjivanjem snage motora  $P_s$  su prikazani na dijagramu slika 10.4.

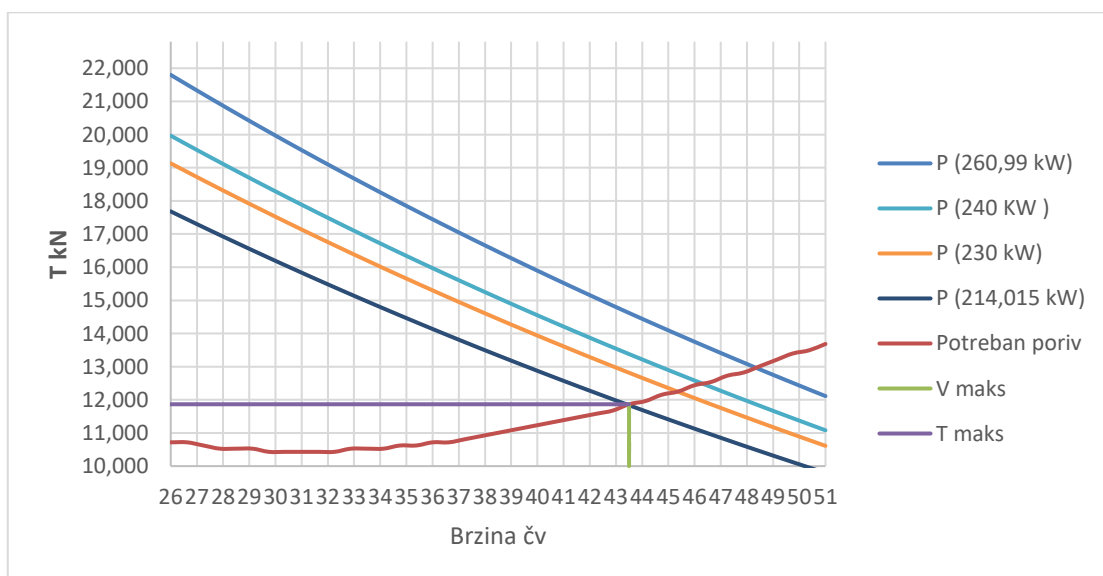

Slika 10.4. Porivi vodomlaznih propulzora dobiveni iteracijskim putem

Sa dijagrama na slici 10.4. vidi se kako je za postizanje poriva od 11,866 kN potrebna je snaga jednog motora od točno 214,015 kW (286,998 HP).

## 10.2. Odabir pogonskog motora

Na izračunatu snagu motora  $P_G$  dodaje se projektna rezerva od 10 %, snaga jednog motora zatim iznosi:

$$P_B = 235,417 \text{ kW}$$

Prema izračunatoj snazi motora od 235,417 kW odabran je pogonski motor Volvo Penta D6-330, slika 10.5.



Slika 10.5. Volvo Penta D6-330 [34]

Tehničke karakteristike motora Volvo Penta D6-330 su prikazane na slici 10.6.

<b>Technical Data</b>	
Engine designation	D6-330 I
Crankshaft power, kW (hp)	243 (330)
Propeller shaft power, kW (hp)	237 (322)
Engine speed, rpm	3500
Displacement, l (in <sup>3</sup> )	5.5 (336)
Number of cylinders	6
Bore/stroke, mm (in.)	103/110 (4.06/4.33)
Compression ratio	17.5:1
Dry weight with HS63AE, kg (lb)	656 (1446)
Dry weight with HS80AE, kg (lb)	677 (1493)
Dry weight with HS80IVE, kg (lb)	721 (1590)
Ratio HS63AE	2.04:1, 1.56:1
Ratio HS63IVE	1.99:1, 1.56:1
Ratio HS80AE	2.5:1, 1.9:1, 1.57:1
Ratio HS80IVE	2.49:1
Emission compliance	IMO NOx, EU RCD Stage II, US EPA Tier 3
Rating	R4* & R5**

Slika 10.6. Tehničke karakteristike motora Volvo Penta D6-330 [34]

Prema tehničkim karakteristikama snaga pogonskog motora iznosi 243 kW što je dovoljno blizu izračunatoj snazi motora od 235, 417 kW.

### 10.3. Odabir vodomlaznog propulzora

Vodmlazni propulzor se bira prema karakteristike odabranog pogonskog motora, slika 10.6. te prema minimalnom promjeru impelera  $D_I$  koji za brzinu od 43,5 čv iznosi 0,187 m, tablica 10.2.

Odabran je vodmlazni propulzor DJ110, proizvođača Thrustmaster, slika 10.7.

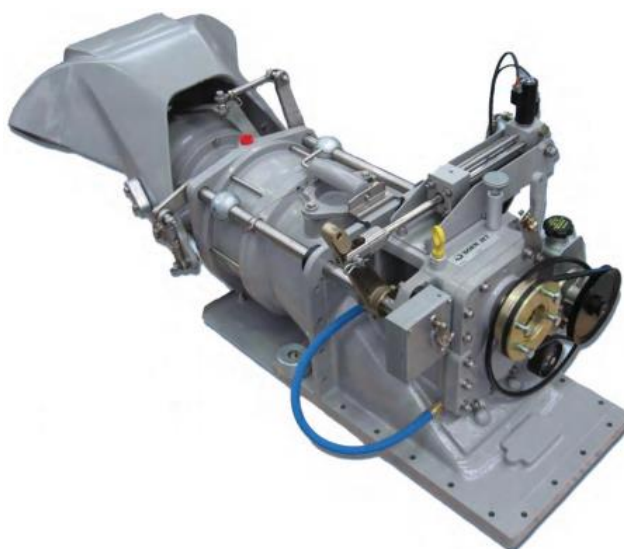

Slika 10.7. Vodmlazni propulzor DJ110 [35]

Karakteristike Vodmlaznog propulzora su prikazane na slici 10.8.

		DJ100G	DJ105	DJ110	DJ120	DJ130	DJ140	DJ170HP
Power Range kW (hp)		225 (300)	260 (350)	335 (450)	380 (510)	410 (550)	670 (900)	855 (1150)
Max RPM		3600	3200	3055	2800	2600	2250	1975
Max. Displacement PLANING VESSEL	Single	3.5t	4t	4.5t	6t	7t	9t	12t
	Twin	8t	9t	10t	12t	17t	20t	26t
Max. Displacement DISPLACING VESSEL	Single	8t	9t	10t	15t	18t	20t	30t
	Twin	17t	20t	22t	30t	40t	45t	66t
Weight Kg (lbs)	Dry	125 (276)	170 (375)	180 (397)	225 (496)	295 (650)	375 (826)	550 (1213)

Slika 10.8. Karakteristike vodmlaznog propulzora DJ110 [35]

Promjer impelera vodomlaznog propulzora DJ 100 G iznosi 0,267 m.

Prema karakteristikama vodmlaznog propulzora, slika 10.8. maksimalni broj okretaja iznosi  $3055 \text{ min}^{-1}$ , kako je maksimalni broj okretaja pogonskog motora  $3500 \text{ min}^{-1}$  potrebno je odabrati reduktor. Prikladan prijenosni omjer redukcije iznosi 1,145:1.

Za maksimalnu brzinu vrtnje pogonskog motora od  $3500 \text{ min}^{-1}$  odabran je reduktor Twin Disc Technodrive TM 265, slika 10.9.



*Slika 10.9. Reduktor Twin Disc Technodrive TM 265 [36]*

Za brzinu vrtnje od maksimalno  $3500 \text{ min}^{-1}$  dostupni prijenosni omjeri reduktora Twin Disc Technodrive TM 265 su prikazani na slici 10.10.

Gearbox model	Ratio	Transfer ratio "A"	Transfer ratio "B"
TM 265 Gearbox	1,17	1,17:1	1,17:1
	1,50	1,50:1	1,50:1
	2,09	2,09:1	2,09:1
	2,82	2,82:1	2,82:1

*Slika 10.10. Dostupni prijenosni omjeri reduktora Twin Disc Technodrive TM 265 [36]*

Sa odabranim prijenosnim omjerom od 1,17:1, maksimalan broj okretaja motora od  $3500 \text{ min}^{-1}$  se smanjio na  $2991,45 \text{ min}^{-1}$ . Maksimalan broj okretaja vodomlaznog propulzora iznosi  $3055 \text{ min}^{-1}$  što čini reduktor prikladnim.

Potrebno je ponovno provjeriti proračun poriva vodomlaznih propulzora za snagu pogonskog motora  $P_s$  od 243 kW te za promjer impelera  $D_I$  od 267 mm prema tablici 10.2. Dijagram poriva vodomlaznih propulzora je prikazan na slici 10.11.

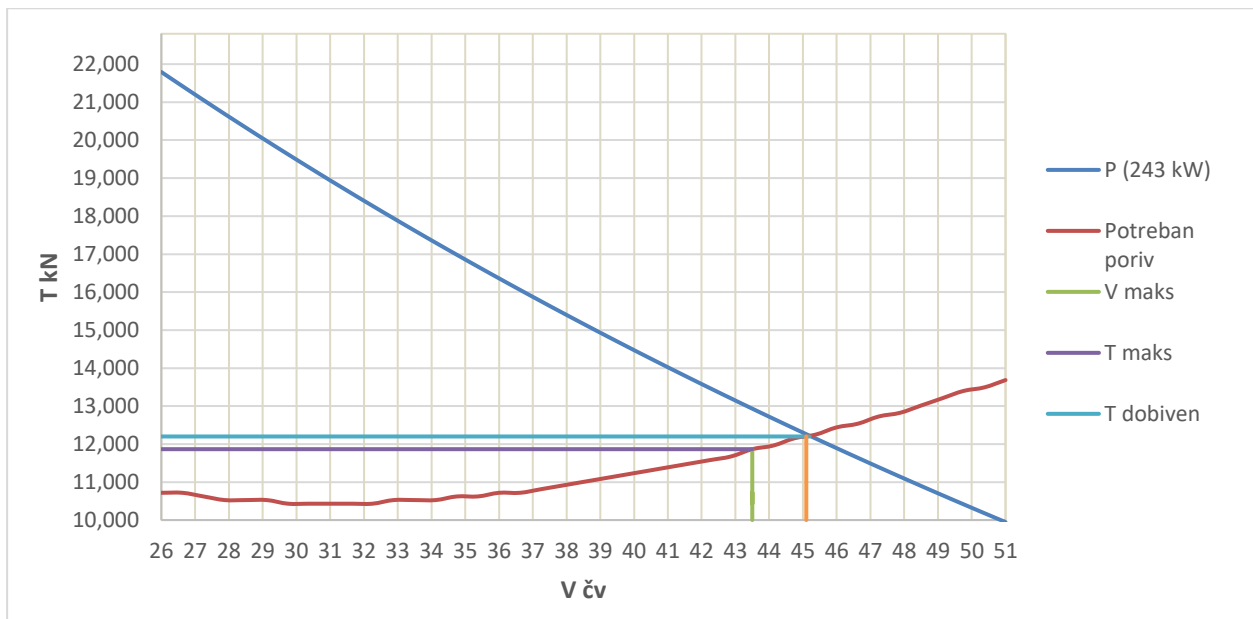

*Slika 10.11. Dijagram poriva vodomlaznih propulzora*

Iz dijagrama se očitava postignuta brzina od 45,2 čv za snagu pogonskog motora  $P_S$  od 243 kW i za promjer impelera vodomlaznog propulzora  $D_I$  od 0,267 m. Radi radi razlike u promjerima impelera vodomlaznog propulzora, vodomlazni pogonski sustav generira veći poriv i postiže veću brzinu. Razlika između zahtijevane brzine od 43,5 čv i postignute brzine od 45,2 čv je dovoljno mala kako bi se odabrani motor i odabrani vodomlazni propulzor koristili u svrhe preliminarnog projekta.



## 11. ODABIR IZVANBRODSKOG POGONSKOG SUSTAVA

### 11.1. Proračun otpora

Druga od zahtijevanih izvedbi pogonskog sustava je izvedba sa izvanbrodskim motorom. Proračun izvanbrodskog pogonskog sustava započinje sa procjenom otpora forme. Snaga i sila otpora su dobiveni analizom izvedene forme u programu Maxsurf, tablica 9.1. Dio Maxsurf programskog paketa pomoću kojeg se može odrediti otpor forme naziva se Maxsurf Resistance. Za proračun otpora odabrana je metoda najpogodnija za glisiranje, „Savitsky planing“, kao i kod vodomlazne izvedbe.

Odabrani raspon brzina za računanje otpora iznosi 35-50 čv. Pri računanju otpora korišteni su izračunati gaz i LCG prilikom proračuna mase i težišta.

*Tablica 11.1. Vrijednosti dobivene u programu Maxsurf Resistance*

V, čv	V, ms	R <sub>T</sub> , kN	P <sub>E</sub> , kW
30,000	15,433	9,200	142,268
30,500	15,691	9,200	145,032
31,000	15,948	9,300	147,885
31,500	16,205	9,300	150,828
32,000	16,462	9,300	153,864
32,500	16,719	9,400	156,994
33,000	16,977	9,400	160,219
33,500	17,234	9,500	163,542
34,000	17,491	9,500	166,964
34,500	17,748	9,600	170,487
35,000	18,006	9,700	174,113
35,500	18,263	9,700	177,842
36,000	18,520	9,800	181,676
36,500	18,777	9,900	185,617
37,000	19,034	10,000	189,666
37,500	19,292	10,000	193,824
38,000	19,549	10,100	198,093
38,500	19,806	10,200	202,474
39,000	20,063	10,300	206,969
39,500	20,321	10,400	211,579
40,000	20,578	10,500	216,305
40,500	20,835	10,600	221,148
41,000	21,092	10,700	226,110
41,500	21,349	10,800	231,192
42,000	21,607	10,900	236,395
42,500	21,864	11,100	241,721

43,000	22,121	11,200	247,170
43,500	22,378	11,300	252,745
44,000	22,636	11,400	258,446
44,500	22,893	11,500	264,274
45,000	23,150	11,700	270,231
45,500	23,407	11,800	276,318
46,000	23,664	11,900	282,536
46,500	23,922	12,100	288,886
47,000	24,179	12,200	295,370
47,500	24,436	12,400	301,989
48,000	24,693	12,500	308,744
48,500	24,951	12,700	315,636
49,000	25,208	12,800	322,666
49,500	25,465	13,000	329,836
50,000	25,722	13,100	337,147

## 11.2. Koeficijenti propulzije

Nakon što su za zadan raspon brzina dobivene vrijednosti snage i sile, potrebno je odrediti vrijednosti koje će služiti za odabir pogonskog motora i njemu prikladnog vijka.

Vrijednosti se određuju iz tablice propulzija-trup interaktivnih faktora, slika 10.1. Potrebno je prvo odrediti Freudov broj na bazi volumena brodske forme prema jednadžbi 10.2.

$$\nabla = 5,074 \text{ m}^3$$

$$Fr_{\nabla} = 10,597$$

$w$  – koeficijent sustrujanja

Koeficijent sustrujanja je određen iz tablice propulzija-trup interaktivnih faktora, slika 10.1.

$$w = 0,03$$

$t$  – koeficijent pada poriva

Koeficijent pada poriva je određen iz tablice propulzija-trup interaktivnih faktora, slika 10.1.

$$t = 0$$

$\eta_H$  – stupanj utjecaja trupa

$$\eta_H = \frac{1-t}{1-w} \quad (11.1)$$

$$\eta_H = 1,031$$

$\eta_R$  – stupanj prijelaza

Stupanj prijelaza je određen srednjom vrijednošću navedenih koeficijenata iz tablice propulzija-trup interaktivnih faktora, slika 10.1.

$$\eta_R = \frac{0,97 + 1,01}{2}$$

$$\eta_R = 0,99$$

$\eta_S$  – stupanj korisnosti transmisije

Za  $\eta_S$  se pretpostavlja vrijednost 0,99.

$V_A$  – brzina pritjecanja vode vijku

$$V_A = V \cdot (1 - w) \quad (11.2)$$

T – sila poriva

$$T = \frac{R_T}{1-t} \quad (11.3)$$

Izračunate vrijednosti su prikazane u tablici 11.2.

*Tablica 11.2. Koeficijenti propulzije*

V, čv	V, ms	R <sub>T</sub> , kN	P <sub>E</sub> , kW	w	V <sub>A</sub> , ms	t	$\eta_H$	$\eta_R$	$\eta_S$	T, kN
30,0	15,433	9,200	142,268	0,030	14,970	0,000	1,031	0,990	0,990	9,200
30,5	15,691	9,200	145,032	0,030	15,220	0,000	1,031	0,990	0,990	9,200
31,0	15,948	9,300	147,885	0,030	15,469	0,000	1,031	0,990	0,990	9,300
31,5	16,205	9,300	150,828	0,030	15,719	0,000	1,031	0,990	0,990	9,300
32,0	16,462	9,300	153,864	0,030	15,968	0,000	1,031	0,990	0,990	9,300
32,5	16,719	9,400	156,994	0,030	16,218	0,000	1,031	0,990	0,990	9,400
33,0	16,977	9,400	160,219	0,030	16,467	0,000	1,031	0,990	0,990	9,400
33,5	17,234	9,500	163,542	0,030	16,717	0,000	1,031	0,990	0,990	9,500
34,0	17,491	9,500	166,964	0,030	16,966	0,000	1,031	0,990	0,990	9,500
34,5	17,748	9,600	170,487	0,030	17,216	0,000	1,031	0,990	0,990	9,600
35,0	18,006	9,700	174,113	0,030	17,465	0,000	1,031	0,990	0,990	9,700
35,5	18,263	9,700	177,842	0,030	17,715	0,000	1,031	0,990	0,990	9,700
36,000	18,520	9,800	181,676	0,030	17,964	0,000	1,031	0,990	0,990	9,800
36,500	18,777	9,900	185,617	0,030	18,214	0,000	1,031	0,990	0,990	9,900
37,000	19,034	10,000	189,666	0,030	18,463	0,000	1,031	0,990	0,990	10,000
37,500	19,292	10,000	193,824	0,030	18,713	0,000	1,031	0,990	0,990	10,000

38,000	19,549	10,100	198,093	0,030	18,962	0,000	1,031	0,990	0,990	10,100
38,500	19,806	10,200	202,474	0,030	19,212	0,000	1,031	0,990	0,990	10,200
39,000	20,063	10,300	206,969	0,030	19,461	0,000	1,031	0,990	0,990	10,300
39,500	20,321	10,400	211,579	0,030	19,711	0,000	1,031	0,990	0,990	10,400
40,000	20,578	10,500	216,305	0,030	19,960	0,000	1,031	0,990	0,990	10,500
40,500	20,835	10,600	221,148	0,030	20,210	0,000	1,031	0,990	0,990	10,600
41,000	21,092	10,700	226,110	0,030	20,459	0,000	1,031	0,990	0,990	10,700
41,500	21,349	10,800	231,192	0,030	20,709	0,000	1,031	0,990	0,990	10,800
42,000	21,607	10,900	236,395	0,030	20,958	0,000	1,031	0,990	0,990	10,900
42,500	21,864	11,100	241,721	0,030	21,208	0,000	1,031	0,990	0,990	11,100
43,000	22,121	11,200	247,170	0,030	21,457	0,000	1,031	0,990	0,990	11,200
43,500	22,378	11,300	252,745	0,030	21,707	0,000	1,031	0,990	0,990	11,300
44,000	22,636	11,400	258,446	0,030	21,956	0,000	1,031	0,990	0,990	11,400
44,500	22,893	11,500	264,274	0,030	22,206	0,000	1,031	0,990	0,990	11,500
45,000	23,150	11,700	270,231	0,030	22,455	0,000	1,031	0,990	0,990	11,700
45,500	23,407	11,800	276,318	0,030	22,705	0,000	1,031	0,990	0,990	11,800
46,000	23,664	11,900	282,536	0,030	22,955	0,000	1,031	0,990	0,990	11,900
46,500	23,922	12,100	288,886	0,030	23,204	0,000	1,031	0,990	0,990	12,100
47,000	24,179	12,200	295,370	0,030	23,454	0,000	1,031	0,990	0,990	12,200
47,500	24,436	12,400	301,989	0,030	23,703	0,000	1,031	0,990	0,990	12,400
48,000	24,693	12,500	308,744	0,030	23,953	0,000	1,031	0,990	0,990	12,500
48,500	24,951	12,700	315,636	0,030	24,202	0,000	1,031	0,990	0,990	12,700
49,000	25,208	12,800	322,666	0,030	24,452	0,000	1,031	0,990	0,990	12,800
49,500	25,465	13,000	329,836	0,030	24,701	0,000	1,031	0,990	0,990	13,000
50,000	25,722	13,100	337,147	0,030	24,951	0,000	1,031	0,990	0,990	13,100

### 11.3. Odabir pogonskog motora

Za brzinu od 43,5 čvorova kočena snaga motora se računa prema jednadžbi:

$$P_B = \frac{P_E}{\eta_P} \quad (11.3)$$

$\eta_0$  – stupanj djelovanja vijka

Kako bi se odredila kočena snaga motora za  $\eta_0$  se pretpostavlja vrijednost 0,6.

$\eta_P$  – stupanja djelovanja propulzije

$$\eta_P = \eta_S \cdot \eta_H \cdot \eta_R \cdot \eta_0 \quad (11.4)$$

$$\eta_P = 0,606$$

$$P_E = 252,745 \text{ kW}$$

$$P_B = 417,070 \text{ kW}$$

Na izračunatu kočenu snagu motora  $P_B$  dodaje se projektna rezerva od 10 %, pa kočena snaga zatim iznosi

$$P_B = 458,778 \text{ kW}$$

Iz razloga što pogonski sustav sadrži dva pogonska motora izračunata kočena snaga se moram podijeliti sa dva kako bi dobili kočenu snagu jednog motora:

$$P_{B \text{ Jednog motora}} = 229,389 \text{ kW}$$

Odabran je vanbrodski motor Suzuki DF300AP, slika 11.1.



Slika 11.1. Slika motora Suzuki DF300AP [37]

Karakteristike motora Suzuki DF300AP su prikazane na slici 11.2.

MODEL	DF300AP	DF250AP
ENGINE TYPE	4-Stroke DOHC 24-Valve	
FUEL DELIVERY SYSTEM	Multi Point Sequential Electronic Fuel Injection	
TRANSOM HEIGHT mm (in.)	X: 635 (25), XX: 762 (30)	
STARTING SYSTEM	Electric	
DRY WEIGHT kg (lbs.) <small>Including battery cable, not including propeller and engine oil</small>	X: 274 (604), XX: 279 (615)	
NO. OF CYLINDERS	V6 (55-degree)	
PISTON DISPLACEMENT cm <sup>3</sup> (cu.in.)	4,028 (245.6)	
BORE x STROKE mm (in.)	98 x 89 (3.81 x 3.46)	
MAXIMUM OUTPUT kW(PS)/rpm	220.7 (300)/6000	184 (250)/5800
FULL THROTTLE OPERATING RANGE rpm	5700-6300	5500-6100
STEERING	Remote	
OIL PAN CAPACITY Lit (U.S. / Imp. qt.)	8.0 (8.5/7.0)	
IGNITION SYSTEM	Fully-transistorized	
ALTERNATOR	12V 54A	
ENGINE MOUNTING	Shear Mount	
TRIM METHOD	Power Trim and Tilt	
GEAR RATIO	2.08 : 1 (Two-stage Reduction Gear)	
GEAR SHIFT	F-N-R (Electronic)	
EXHAUST	Through Prop Hub Exhaust	
DRIVE PROTECTION	Rubber Hub	
PROPELLER SIZE (in.) Diameter x Pitch	Regular and Counter Rotation	
	16 x 15**	15-1/2 x 17
	16 x 17	15-1/4 x 19
3-BLADE STAINLESS STEEL TYPE	16 x 18.5	15 x 21
	16 x 20	14-3/4 x 23
OPTIONAL	16 x 21.5	14-1/2 x 25
	16 x 23	14-1/2 x 27
	16 x 24.5	
	16 x 26	
	16 x 27.5**	**Regular Rotation only

Slika 11.2. Karakteristike motora Suzuki DF300AP [37]

Proračunom je dobivena kočena snaga motora od 229,389 kW. Snaga odabranog motora iznosi 220,7 kW, razlika u snazi kočene snage je prihvatljiva za preliminarni proračun.

#### 11.4. Odabir brodskog vijka

Vijak će se odrediti pomoću programa Bseries. U program Bseries se ulazi sa promjerom od 16 inča odnosno 406,4 mm (16 inča), brzinom vrtnje vijka od  $3028,85 \text{ min}^{-1}$ , i snagom od 220,07 kW određenim prema slici 9.2. Brzina pritjecanja vode vijku  $V_A$  i poriv  $T$  s kojima se također ulazi u program su odabrani za brzinu od 43,5 čv. Karakteristike optimalnog vijka prikazane u tablici 11.3.

Tablica 11.3. Karakteristike optimalnog vijka dobivene Bseries programom

Broj krila $Z$	3
Promjer brodskog vijka	406,4 mm
Uspjon vijka	503 mm
AE/A0 (pretpostavljamo)	0,8
Broj okretaja vijka	$3028,85 \text{ min}^{-1}$
Stupanj djelovanja vijka	0,728

Prema dobivenim karakteristikama odabire se vijak na tržištu sa najbližnjim karakteristikama.

Odabran je izvanbrodski vijak Suzuki RH Stainless Steel 16" x 20" , slika 11.3.



Slika 11.3. Brodski vijak Suzuki RH Stainless Steel 16" x 20" [38]

Sa odabranim vijkom opet se ulazi u Bseries program za brzinu od 43,5 čv. Karakteristike odabranog vijka su prikazane u tablici 11.4.

*Tablica 11.4. Karakteristike odabranog vijka dobivene Bseries programom*

Broj krila Z	3
Promjer brodskog vijka	406 mm
Uspjon vijka	508 mm
AE/A0	0,8
Broj okretaja vijka	2890,02 $min^{-1}$
Stupanj djelovanja vijka	0,7215

Sa karakteristikama brodskog vijka se izrađuje prognozni dijagram.

#### **10.4. Prognozni dijagram**

Prognozni dijagram se radi kako bi se procijenila brzina plovila te brzina vrtnje brodskog vijka za odabrani motor i odabrani vijak. Prognozni dijagram se radi za raspon brzina od 30-50 čv, a radi jednostavnosti se uzima raspon svakih 2,5 čv. Podaci za izradu prognoznog vijka se dobivaju pomoću programa Bseries. U program Bseries ulazi se sa izračunatim vrijednostima potrebnog poriva T, brzinom pritjecanja vode vijku  $V_A$  te karakteristikama odabranog vijka. Kao rezultat dobiva se broj okretaja vijka N i snaga predana vijku  $P_B$ .

Vrijednosti dobivene putem programa Bseries su prikazane u tablici 11.5.

*Tablica 11.5. Vrijednosti dobivene putem programa Bseries*

V, kN	$P_B$ , kW	N, $m^{-1}$
30	94,688	2156,25
32,5	103,719	2282,61
35	115,437	2416,69
37,5	128,666	2553,52
40	144,01	2693,83
42,5	159,05	2831,23
45	177,16	2973,53
47,5	203,764	3130,38
50	226,529	3272,9

Sa dobivenim vrijednostima se radi prognozni dijagram.

Prognozni dijagram je prikazan na slici 11.4.

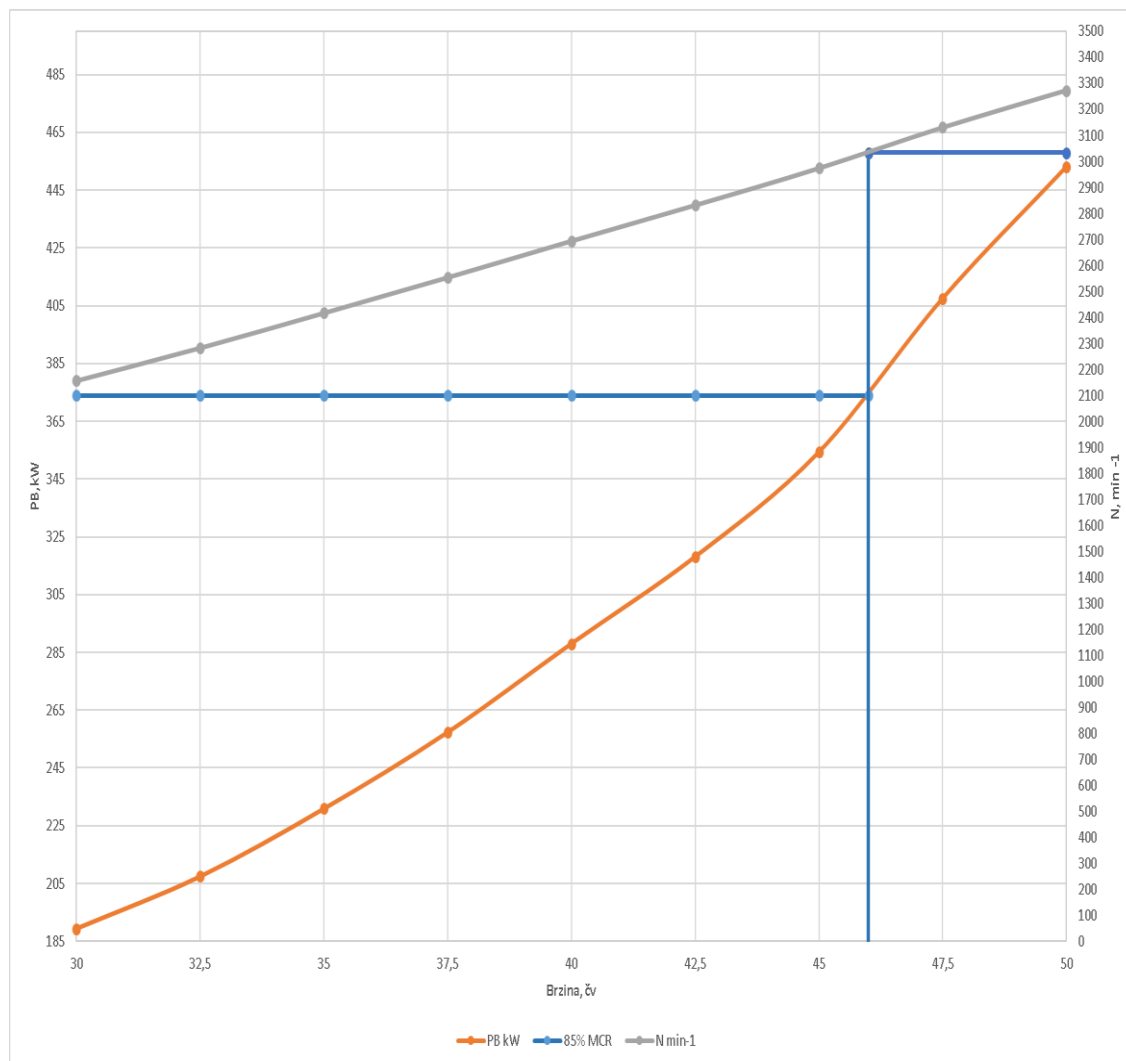

Slika 11.4. Prognozni dijagram

U prognostic dijagram se ulazi sa 85% ukupne snage oba pogonska motora odnosno sa 374,119 kW. Iz prognostic dijagrama očitana je brzina od 46 čv i brzina okretaja vijka od 3043 min<sup>-1</sup>.

### 11.5. Provjera poriva

Uz prognostic dijagram rezultati poriva se još jednom provjeravaju pomoću Bseries KT\_ KQ\_  $\eta_0$  programa kako bi se na drugi način odredila brzina. U program se ulazi sa karakteristikama odabranog vijka te sa vrijednostima brzina u rasponu od 30-50 čv, a radi jednostavnosti se uzima raspon svakih 2,5 čv. Kao rezultat dobiva se sila poriva odabranog broskog vijka T. Dobiveni poriv T se zatim uspoređuje sa potrebnim porivom.

Dijagram dobiven pomoću Bseries KT\_ KQ\_  $\eta_0$  programa je prikazan na slici 11.5.



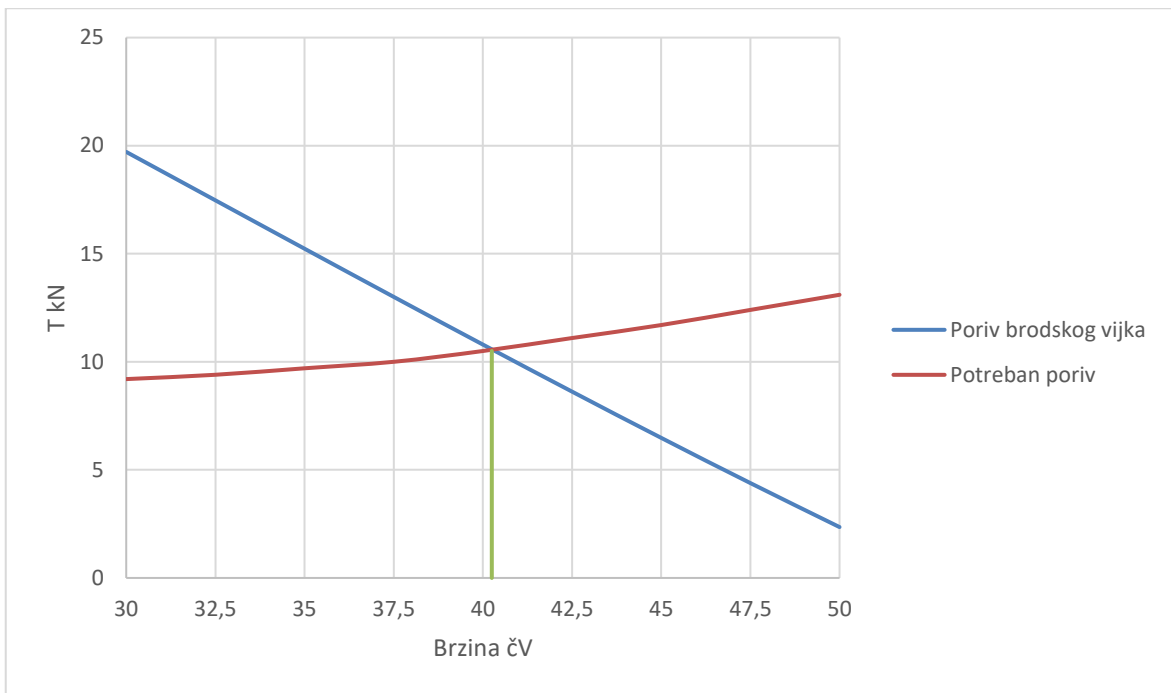

*Slika 11.5. Rezultati Bseries KT\_ KQ\_  $\eta_0$  programa*

Prema dobivenima vrijednostima Bseries KT\_ KQ\_  $\eta_0$  programa očitana je stvarna brzina broda od 40,25 čv. Rezultat stvarne brzine broda dobiven prognoznim dijagramom od 46 čv i rezultat dobiven Bseries KT\_ KQ\_  $\eta_0$  pokazuju veliku razliku naspram zahtjevane brzine od 43,5 čv. U drugom krugu spirale potrebno je detaljnije provjeriti proračun izvanbrodskog pogonskog sustava.

## 12. STABILITET PLOVILA

Proračun stabilitet plovila se računa prema normi EN ISO 12217-1:2017. Za proračun stabiliteta plovila prema normi EN ISO 12217-1:2017 korištene su poluge stabiliteta dobivene putem programa Maxsurf. Dio Maxsurf programskog paketa pomoću kojeg se može odrediti poluga stabiliteta naziva se Maxsurf Stability.

Poluga stabiliteta za izvedbu sa izvanbrodskim pogonskim sustavom za stanje krcanja  $M_{MO}$  je prikazana na slici 12.1.

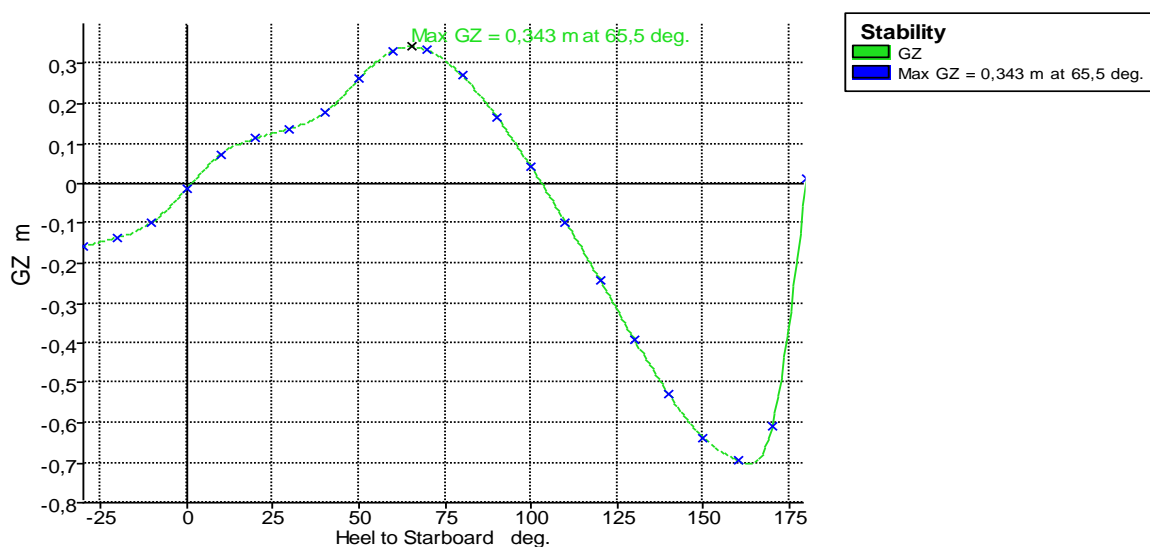

Slika 12.1. Poluga stabiliteta za izvanbrodski pogonski sustav za stanje krcanja  $M_{MO}$

Poluga stabiliteta za izvedbu sa izvanbrodskim pogonskim sustavom za stanje krcanja  $M_{LA}$  je prikazana na slici 12.2.

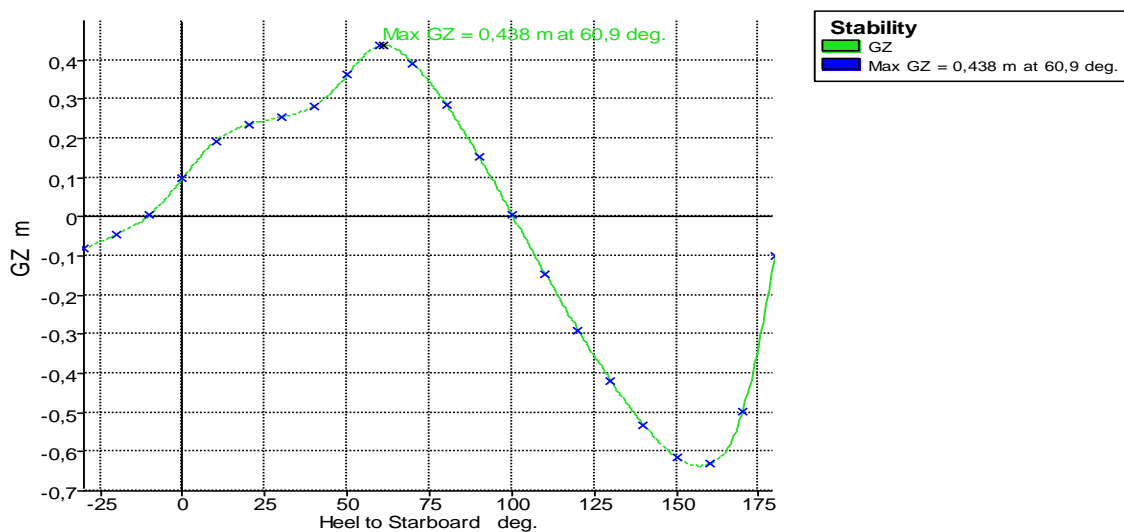

Slika 12.2. Poluga stabiliteta za izvanbrodski pogonski sustav za stanje krcanja  $M_{LA}$

Poluga stabiliteta za izvedbu sa vodomlaznim pogonskim sustavom za stanje krcanja  $M_{MO}$  je prikazana na slici 12.3.

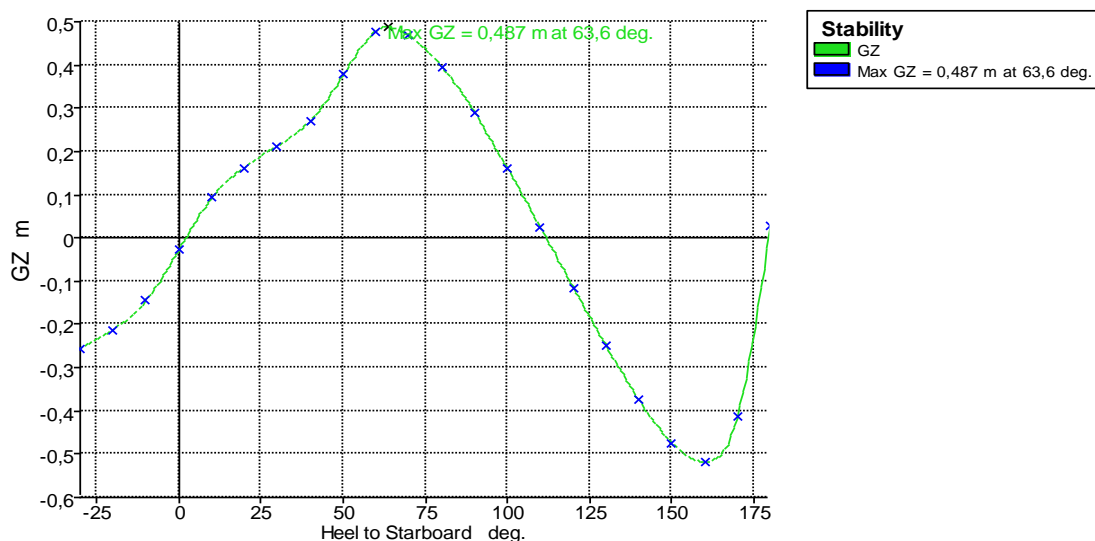

Slika 12.3. Poluga stabiliteta za vodomlazni pogonski sustav za stanje krcanja  $M_{MO}$

Poluga stabiliteta za izvedbu sa vodomlaznim pogonskim sustavom za stanje krcanja  $M_{LA}$  je prikazana na slici 12.4.

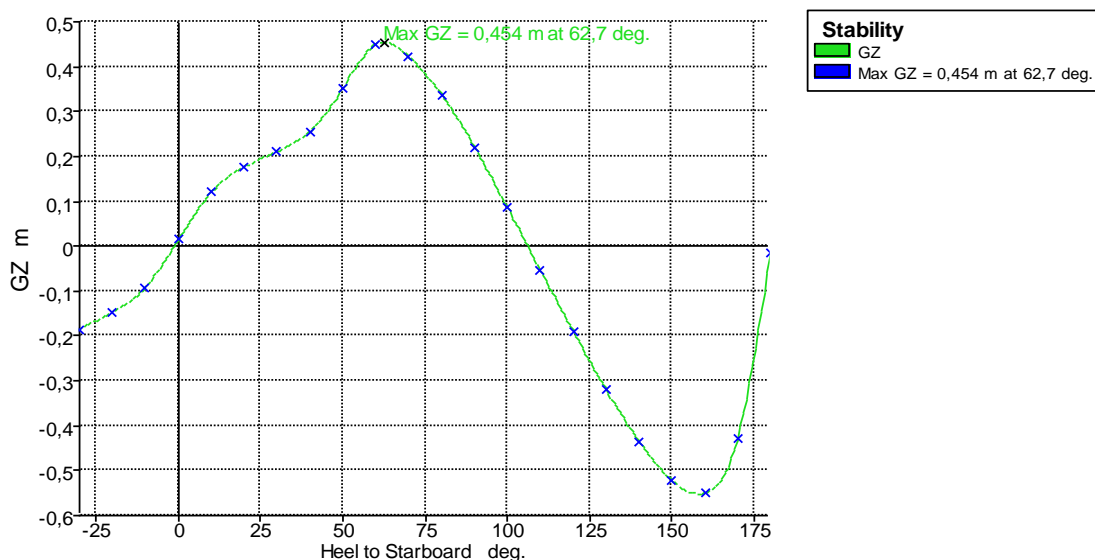

Slika 12.4. Poluga stabiliteta za vodomlazni pogonski sustav za stanje krcanja  $M_{LA}$

Izvedba sa vodomlaznim pogonskim sustavom ispunjava kriterije za projektnu kategoriju B prema normi EN ISO 12217-1:2017. Rezultati zahtijevanih kriterija se mogu provjeriti prema radnoj listi (tabličnom kalkulatoru) koja je dana u prilogu.

Izvedba sa izvanbrodskim pogonskim sustavom ne ispunjava kriterije za projektnu kategoriju B prema normi EN ISO 12217-1:2017. Rezultati zahtijevanih kriterija se mogu provjeriti prema radnoj listi (tabličnom kalkulatoru) koja je dana u prilogu. Za izvedbu sa izvanbrodskim pogonskim sustavom u drugom krugu projektne spirale potrebno je ponoviti proračun masa i težišta sa prilagođenim vrijednostima. Eventualno bi se moglo za B kategoriju provjeriti kriterije za manji broj osoba.

Za projektnu kategoriju C obje izvedbe ispunjavaju kriterije prema normi EN ISO 12217-1:2017 što se može provjeriti prema radnoj listi (tabličnom kalkulatoru) koja je dana u prilogu.

## 12. ZAKLJUČAK

Brodogradnja je industrija koja zahtijeva visok stupanj stručnosti i preciznosti jer se bavi projektiranjem i gradnjom plovila koja moraju biti sigurna, učinkovita i ekološki prihvatljiva. Razina složenosti plovila se povećava s rastućim zahtjevima koja su za njega namijenjena, sukladno tome se povećava i složenost njihovog projektiranja.

Ključno je razumjeti da se proces projektiranja temelji podjelom kompleksnih problema na manje, rješive dijelove. Projektna spirala je metoda projektiranja plovila pomoću koje se iterativnim postupcima usavršava projektirano plovilo, na taj način se kompleksan zadatak projektiranja plovila podijelio na više rješivih dijelova.

Preliminarni projekt rekreacijskog brzog motornog plovila s dužinom od 10-ak metara, koji je tema ovog diplomskog rada, predstavlja jedan od početnih koraka pri projektiranju plovila koristeći metodu projektne spirale. U radu je prikazano na koji način se započinje sa projektiranjem plovila te logičan slijed tehničkih i kreativnih koraka kojima se približava krajnjoj formi plovila. Diplomski rad predstavlja prvi krug projektne spirale, u sljedećim iteracijama oblik forme plovila, centracije masa kao i odabir pogonskih sustava se usavršavaju na temelju prijašnjih koraka.

Preliminarni projekt rekreacijskog brzog motornog plovila s dužinom od 10-ak metara sadrži sve potrebne proračune i nacрте za izvedbu sa izvanbrodskim i vodomlaznim pogonskim sustavom. Na temelju projektnog zahtjeva u preliminarnom projektu je razvijena forma plovila u skladu sa parametrima gliserske forme. Obavljen je proračun masa te proračun mase i težišta za izvedbu sa izvanbrodskim i vodomlaznim pogonom. Pomoću spomenutih proračuna obavljeni su odabrani pogonskih sustavi za obje izvedbe te je provjeren njihov stabilitet. U drugom krugu projektne spirale pomoću pobliže definiranih masa, parametara plovila i priloženih nacрта potrebno je obratiti pozornost na strukturu plovila koja u prvom krugu nije definirana. Sa novim podacima o masi i parametrima plovila, potrebno je ponovno izvršiti proračun mase i težišta kako bi se osigurala stabilnost broda. Također, potrebno je ponovno razmotriti odabir pogonskih sustava kako bi se prilagodili novim vrijednostima plovila.

## LITERATURA

- [1] Volmar, M: "The Dugout Canoe Project", s Interneta, <https://www.lakeroland.org/wp-content/uploads/2018/09/Dugout-Canoe-2.pdf>, 27. Svibanj 2023.
- [2] „Dugout boats Kierikki Centre Oulu“, s Interneta, [https://commons.wikimedia.org/wiki/File:Dugout\\_boats\\_Kierikki\\_Centre\\_Oulu\\_20130526.JPG](https://commons.wikimedia.org/wiki/File:Dugout_boats_Kierikki_Centre_Oulu_20130526.JPG), 27. Svibanj 2023.
- [3] William F. Edgerton: „Ancient Egyptian Ships and Shipping“, s Interneta, <https://www.jstor.org/stable/pdf/528485.pdf>, 27. Svibanj 2023.
- [4] „Tomb of Simut“, s Interneta, <http://www.runasimi.net/farao-UK.htm>, 27. Svibanj 2023.
- [5] „SHIPS AND SHIPBUILDING“, s Interneta, <https://erenow.net/ancient/ancient-greece-and-rome-7an-encyclopedia-for-students-4-volume-set/413.php>, 31. Svibanj 2023.
- [6] S Interneta, <https://media.rezgo.com/29938/202339/226169.jpg>, 31. Svibanj 2023.
- [7] „Medieval ships: Transition Byzantine Liburna and influences“, s Interneta, <https://naval-encyclopedia.com/medieval-ships.php>, 31. Svibanj 2023.
- [8] S interneta, <https://thevikingherald.com/article/two-extraordinary-14th-century-shipwrecks-discovered-in-sweden/347>, 31. Svibanj 2023.
- [9] „Renaissance ships“, s Interneta, <https://naval-encyclopedia.com/renaissance-ships.php>, 31. Svibanj 2023.
- [10] „18th Century ship designs“, s Interneta, <https://www.alamy.com/stock-photo/18th-century-ship.html?pseudoid=AD7ED31222084EC3AA4D985340213421&sortBy=relevant>, 31. Svibanj 2023.
- [11] „Ships and Boats: 1840-1950“, s Interneta, <https://historicengland.org.uk/images-books/publications/iha-ships-boats-1840-1950/heag133-ships-and-boats-1840-1950-iha/>, 1. Lipanj 2023.
- [12] „The paddle steamer PS Waverley“, s Interneta, <https://en.wikipedia.org/wiki/Steamship>, 1. Lipanj 2023.
- [13] „Computational Fluid Dynamics (CFD)“, s Interneta, <https://www.sva-potsdam.de/en/computational-fluid-dynamics/>, 1. Lipanj 2023.
- [14] Dejhalla, R: „Osnivanje plovnih objekata 1 (01)“, Radni materijal, ver. 1.3. - listopad 2023.
- [15] Spencer, M: „Scarab 255 Impulse Wake Edition“, s Interneta, <https://www.boatdealers.ca/boat-reviews/2016/scarab/255-impulse-wake-edition>, 1. Lipanj 2023
- [16] Vance, R: „Yamaha 275 SD Boat Test“, s Interneta, <https://www.boatingmag.com/story/boats/yamaha-275-sd-boat-test/>, 1. Lipanj 2023.
- [17] „Yamaha AR250“, s Interneta, <https://itboat.com/ru/models/13720-ar250>, 1. Lipanj 2023.

- [18] „HORIZON 290“, s Interneta, <https://www.fourwinns.com/us/boat/horizon-290>, 1. Lipanj 2023.
- [19] „SLX 350“, s Interneta, <https://www.searay.eu/eu/en/models/slx-series/slx-350.html>, 1. Lipanj 2023.
- [20] Murray, S: „Chris-Craft Launch 28 GT“, s Interneta, <https://www.powerandmotoryacht.com/boats/chris-craft-launch-28-gt>, 1. Lipanj 2023.
- [21] „350 Crossover Bowrider“, s Interneta, <http://luxyacht.com/formula-boats/formula-bowriders-crossover-bowriders/350-crossover-bowrider/>, 1. Lipanj 2023.
- [22] „COBALT A29“, s Interneta, <https://cobaltboats.com/models/a29/>, 1. Lipanj 2023.
- [23] „310 Bowrider“, s Interneta, <https://www.formulaboats.com/boats/310-bowrider/#boatdetails>, 1. Lipanj 2023.
- [24] „CHAPARRAL 327 SSX REVIEW“, s Interneta, <https://www.tradeboat.com.au/news-reviews/7621-chaparral-327-ssx-reviewbv>, 1. Lipanj 2023.
- [25] Dong Jin, K. i.dr: „Design of high-speed planing hulls for the improvement of resistance and seakeeping performance“, s Interneta, <https://www.sciencedirect.com/science/article/pii/S2092678216303764>, 10. Srpanj 2023.
- [26] Grubišić, I. Begović, E:“ Upgrading weight prediction in small craft concept design“, 25. Srpanj 2023.
- [27] „Suzuki DF350A“, s Interneta, <https://suzukimarinepress.com/en/releases/suzuki-introduces-df350a-350-hp-v6-4-stroke-outboard/> , 25. Srpanj 2023.
- [28] „BUKH V8 / 350 - 500 HP“, s Interneta, <https://bukh.dk/produkter/7-bukh-210-530hp-high-speed-craft/60-bukh-v8--350---500-hp/>, 25. Srpanj 2023.
- [29] „100 Series Waterjets“, s Interneta, <https://www.thrustmaster.net/waterjet-propulsion/100-series-waterjets/>, 25. Srpanj 2023.
- [30] „Valhalla V-33 Specifications“, s Interneta, <https://itboat.com/models/9961-v-33>, 1. Rujna 2023.
- [31] Savitsky, D: „Hydrodynamic design of PLaning Hulls“, 1. Rujna 2023.
- [32] „Quickly estimate the planing vessel resistance“, s Interneta, <https://shipnerdnews.com/quickly-estimate-the-vessel-resistance/#strong-step-7-trim-of-vessel-in-equilibriu-strong-m> , 1. Rujna 2023.

[33] Blount, L. D., Bartee J. R.:“Design of propulsion systems for high-speedcraft“, 4. Rujna 2023.

[34] „Volvo Penta“ Interneta, [https://www.frenchmarine.com/Datasheets/47709113\\_EN%20\(2\).pdf](https://www.frenchmarine.com/Datasheets/47709113_EN%20(2).pdf) , 4.Rujna 2023.

[35] „Thrustmaster“, s Interneta, <https://www.thrustmaster.net/wp-content/uploads/2014/02/100-series-trifold-brochure-low-res.compressed.pdf>, 5. Rujna 2023

[36] „TWIN DISC TECHNODRIVE TM 265 GEARBOX“, s Interneta, <https://haynav.com/twin-disc-technodrive-tm-265-gearbox/>, 5. Rujna 2023.

[37] „DF300AP“, s Interneta, <https://www.suzukimarine.com/outboard/225-300hp/df300ap/>, 5 Rujna 2023.

[38] „Suzuki RH Stainless Steel“, s Interneta, <https://www.greatlakesskipper.com/suzuki-boat-propeller-rh-stainless-steel-16-x-20-pitch>, 5. Rujna 2023.



## POPIS SLIKA

Slika 2.1. Kanu od izdubljenog debla [2].....	2
Slika 2.2. Zapisi egipatskih plovila [4].....	3
Slika 2.3. Replika starogrčke trijere [6].....	4
Slika 2.4. Slika eskavacije olupine Koge [8].....	5
Slika 2.5. Nacrt broda u doba Renesanse [10].....	5
Slika 2.6. Slika parobroda [12].....	6
Slika 3.1. Vizualizacija projektne spirale [14].....	7
Slika 4.1. Slika glisera Scarab 255 Impulse Wake Edition [15].....	9
Slika 4.2 Slika glisera Yamaha 275 SD [16].....	10
Slika 4.3 Slika broda Yamaha AR 250 [17].....	11
Slika 4.4. Slika glisera Four Winns Horizon H290 [18].....	11
Slika 4.5. Slika glisera Sea Ray SLX 350 [19].....	12
Slika 4.6. Slika glisera Chris-Craft Launch 25 GT [20].....	13
Slika 4.7. Slika glisera 350 Crossover Bowrider [21].....	13
Slika 4.8. Slika glisera Cobalt A29 [22].....	14
Slika 4.9. Slika glisera Formula 310 Bowrider [23].....	14
Slika 4.10. Slika broda Chaparral 327 SSX [24].....	15
Slika 4.11. Računanje polinoma.....	16
Slika 4.12. Ovisnost širine o dužini plovila.....	16
Slika 4.13. Ovisnost gaza dužini plovila.....	16
Slika 4.14. Ovisnost brzine o dužini plovila.....	17
Slika 4.15.. Ovisnost snage o dužini plovila.....	17

Slika 5.1 Plan linija za duboku V formu [25].....	18
Slika 5.2. Razvijena duboka V forma.....	19
Slika 5.3. Oblik glisera s pramčanom palubom i glisera s pramčanim kokpitom.....	19
Slika 5.4. Proširenje pramčanog dijela razvijene forme.....	20
Slika 5.5 Zakrivljenost uzdužnice.....	21
Slika 5.6 Oblik zgiba u tlocrtu.....	22
Slika 5.7 Oblik rebara.....	22
Slika 5.8 Areala rebara.....	22
Slika 5.9. Modificirana forma broda .....	23
Slika 5.10. Brizgobrani i uzdužne strujne vodilice.....	22
Slika 6.1. Faktori oznake za tip usluge prema LR SSC-u [26] .....	26
Slika 6.2. Faktori oznake za servisno područje prema LR SSC [26] .....	27
Slika 6.3. Dimenzije palubne kućice [26].....	27
Slika 6.4. Volumeni, mase i gustoće materijala za palubne kućice [26].....	28
Slika 6.5. Pogonski motor Suzuki DF350A [27] .....	30
Slika 6.6. Karakteristike pogonskog motora Suzuki DF350A [27] .....	30
Slika 6.7. Pogonski motor BUKH VGT 350 [28] .....	31
Slika 6.8. Karakteristike pogonskog motora BUKH VGT 350 [28] .....	31
Slika 6.9. Vodomlazni propulzor Thrustmaster DJ105 serije 100 [29] .....	32
Slika 6.10. Karakteristike vodomlaznog propulzora Thrustmaster DJ105 [29] .....	32
Slika 7.1. Razmještaj glisera sa vodomlaznim pogonom.....	33
Slika 7.2. Razmještaj glisera sa izvanbrodskim pogonom.....	33
Slika 8.1. Proširenje pramčanog dijela forme.....	47

Slika 8.2. Izgled proširene forme.....	47
Slika 9.1. Glisiranje plovila [30].....	50
Slika 9.2. Koelbel-ove krivulje [32].....	52
Slika 9.3. Granice za pliskanje [32].....	53
Slika 10.1. Tablica propulzija-trup interaktivnih faktora [33].....	55
Slika 10.2. Dijagram poriva brodske forme.....	56
Slika 10.3. Dijagram vodomlaznih propulzora $T_{VP}$ .....	59
Slika 10.4. Porivi vodomlaznih propulzora dobiveni iteracijskim putem.....	59
Slika 10.5. Volvo Penta D6-330 [34].....	60
Slika 10.6. Tehničke karakteristike motora Volvo Penta D6-330 [34].....	60
Slika 10.7. Vodomlazni propulzor DJ110 [35].....	61
Slika 10.8. Karakteristike vodomlaznog propulzora DJ110 [35].....	62
Slika 10.9. Reduktor Twin Disc Technodrive TM 265 [36].....	62
Slika 10.11. Dijagram poriva vodomlaznih propulzora.....	63
Slika 11.1. Slika motora Suzuki DF300AP [37].....	68
Slika 11.2. Karakteristike motora Suzuki DF300AP [37].....	68
Slika 11.3. Brodski vijak Suzuki RH Stainless Steel 16" x 20" [38].....	69
Slika 11.4. Prognozni dijagram.....	70
Slika 11.5. Rezultati Bseries KT_ KQ_ $\eta_0$ programa.....	71
Slika 12.1. Poluga stabiliteta za izvanbrodski pogonski sustav za stanje krcanja $M_{MO}$ .....	73
Slika 12.2. Poluga stabiliteta za izvanbrodski pogonski sustav za stanje krcanja $M_{LA}$ .....	73
Slika 12.3. Poluga stabiliteta za vodomlazni pogonski sustav za stanje krcanja $M_{MO}$ .....	74
Slika 12.4. Poluga stabiliteta za vodomlazni pogonski sustav za stanje krcanja $M_{LA}$ .....	75

## POPIS TABLICA

Tablica 4.1. Osnovne karakteristike glisera Scarab 255 Impulse Wake Edition.....	10
Tablica 4.2. Osnovne karakteristike glisera Yamaha 275 SD.....	10
Tablica 4.3. Osnovne karakteristike glisera Yamaha AR 250.....	11
Tablica 4.4. Osnovne karakteristike glisera Winns Horizon H290.....	11
Tablica 4.5. Osnovne karakteristike glisera Sea Ray SLX 350.....	12
Tablica 4.6. Osnovne karakteristike glisera Chris-Craft Launch 28 GT.....	13
Tablica 4.7. Osnovne karakteristike glisera 350 Crossover Bowrider.....	13
Tablica 4.8. Osnovne karakteristike glisera Cobalt A29.....	14
Tablica 4.9. Osnovne karakteristike broda Formula 310 Bowrider.....	15
Tablica 4.10. Osnovne karakteristike glisera Chaparral 327 SSX.....	15
Tablica 4.11. Osnovne karakteristike projektiranog plovila.....	17
Tablica 8.1. Proračun mase i težišta za stanje krcanja $m_{LDC}$ .....	38
Tablica 8.2. Proračun mase i težišta za stanje krcanja $m_{LA}$ .....	39
Tablica 8.5. Proračun mase i težišta za stanje krcanja $m_{MO}$ .....	40
Tablica 8.4. Proračun mase i težišta za stanje krcanja $m_{LDC}$ .....	41
Tablica 8.5. Proračun mase i težišta za stanje krcanja $m_{LA}$ .....	42
Tablica 8.6. Proračun mase i težišta za stanje krcanja $m_{MO}$ .....	43
Tablica 8.7. Položaji težišta za stanje krcanja $m_{LDC}$ .....	45
Tablica 8.8. Položaji težišta za stanje krcanja $m_{LA}$ .....	45
Tablica 8.9. Položaji težišta za stanje krcanja $m_{MO}$ .....	45
Tablica 8.7. Položaji težišta za stanje krcanja $m_{LDC}$ .....	46
Tablica 8.8. Položaji težišta za stanje krcanja $m_{LA}$ .....	46

Tablica 8.9. Položaji težišta za stanje krcanja $m_{MO}$ .....	46
Tablica 8.7. Položaji težišta za stanje krcanja $m_{LDC}$ .....	48
Tablica 8.8. Položaji težišta za stanje krcanja $m_{LA}$ .....	48
Tablica 8.9. Položaji težišta za stanje krcanja $m_{MO}$ .....	48
Tablica 8.7. Položaji težišta za stanje krcanja $m_{LDC}$ .....	49
Tablica 8.8. Položaji težišta za stanje krcanja $m_{LA}$ .....	49
Tablica 8.9. Položaji težišta za stanje krcanja $m_{MO}$ .....	49
Tablica 10.1. Otpor forme i izračunati poriv.....	55
Tablica 10.2. Proračun poriva vodomolaznog propulzora.....	57
Tablica 11.1. Vrijednosti dobivene u programu Maxsurf Resistance.....	64
Tablica 11.2. Koeficijenti propulzije.....	66
Tablica 11.3. Karakteristike optimalnog vijka dobivene Bseries programom.....	69
Tablica 11.4. Karakteristike odabranog vijka dobivene Bseries programom.....	70

## SAŽETAK

U diplomskom radu prikazan je preliminarni projekt rekreacijskog brzog motornog plovila s dužinom od 10-ak metara. Preliminarni projekt je napravljen za izvedbu sa izvanbrodskim i vodomlaznim pogonom. Na temelju razvijene forme za obje izvedbe obavljen je proračun masa, proračun mase i težišta , odabir pogonskih sustava te provjera njihovog stabiliteta.

Ključne riječi: izvanbrodski, vodomlazni, projektna spirala, pogon, masa, težište, forma plovila.

## SUMMARY

In the master's thesis, a preliminary design of a recreational high-speed motorboat with a length of approximately 10 meters is presented. The preliminary design was developed for both outboard and waterjet propulsion systems. Based on the developed hull form for both configurations, calculations of mass, mass distribution and its center of gravity, selection of propulsion systems, and stability checks were carried out.

Keywords: outboard, waterjet, project spiral, propulsion, mass, center of gravity, hull form.

PRILOG 1

NACRT BRODSKIH LINIJA



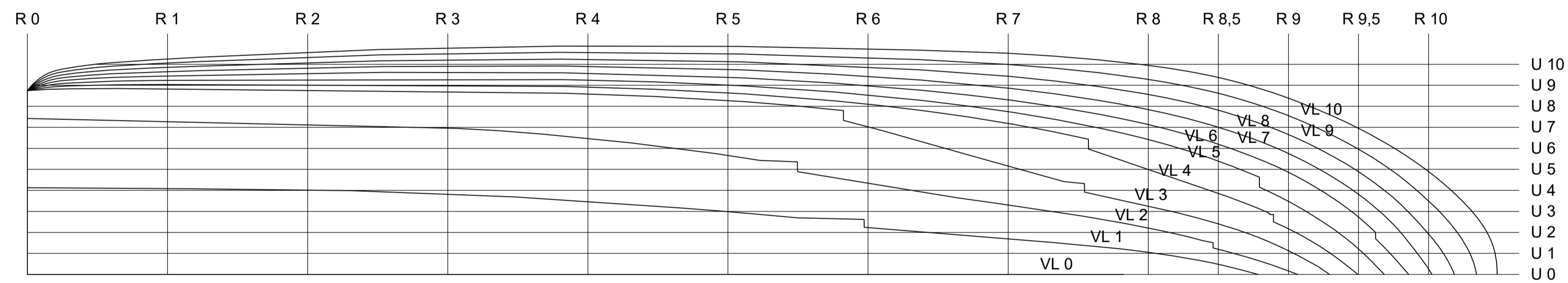
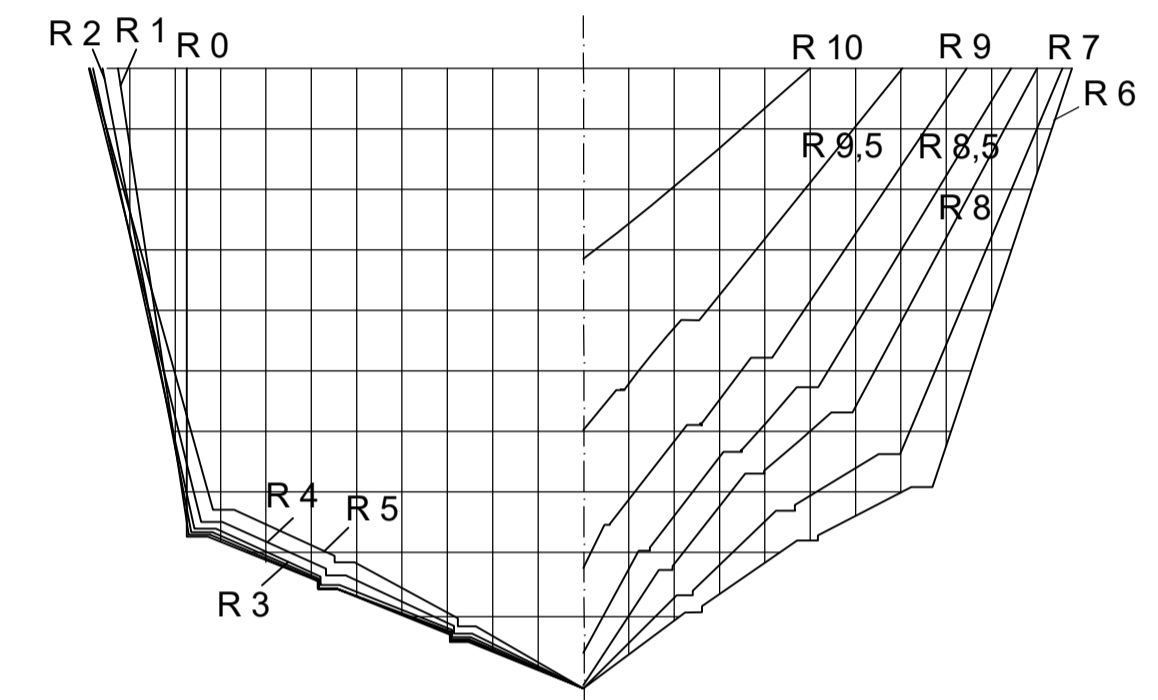
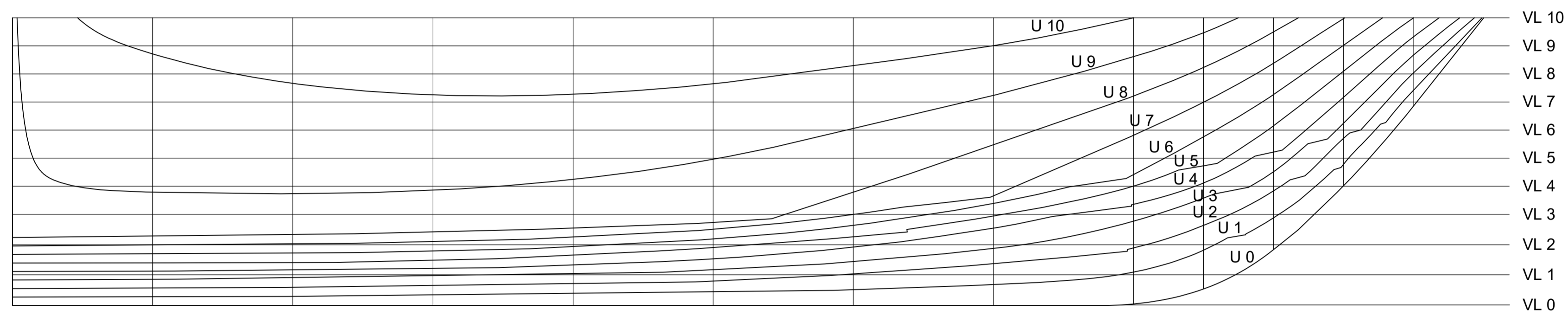

DIPLOMSKI RAD	
SVEUČILIŠTE U RIJECI TEHNIČKI FAKULTET	MJERILO: M 1:25
OPĆI PLAN BRODA	FORMAT: A1
CRTAČ: IVAN KAŠIKIĆ	DATUM:
PREGLEDAČ: ROKO DEJHALLA	12.09.2023.

PRILOG 2

OPĆI PLAN BRODA

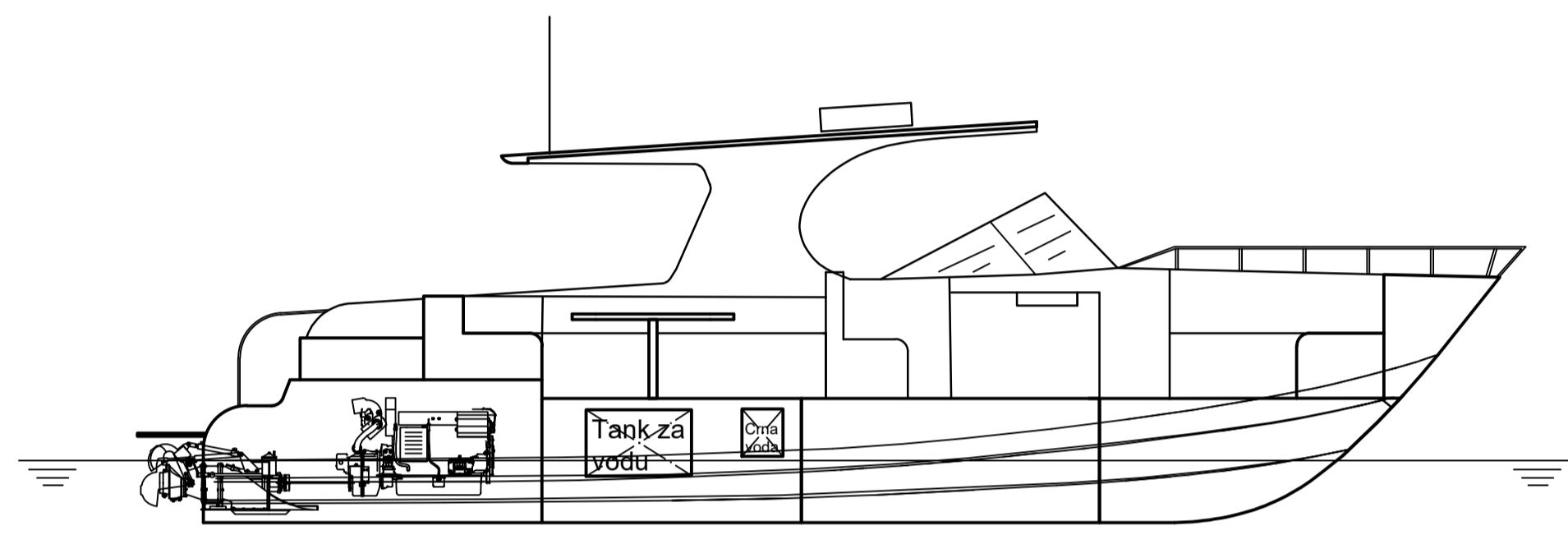

IZVEDBA 1. - S VODOMLAZNYM PROPULZORIMA -  
POGLED NA DESNU STRANU

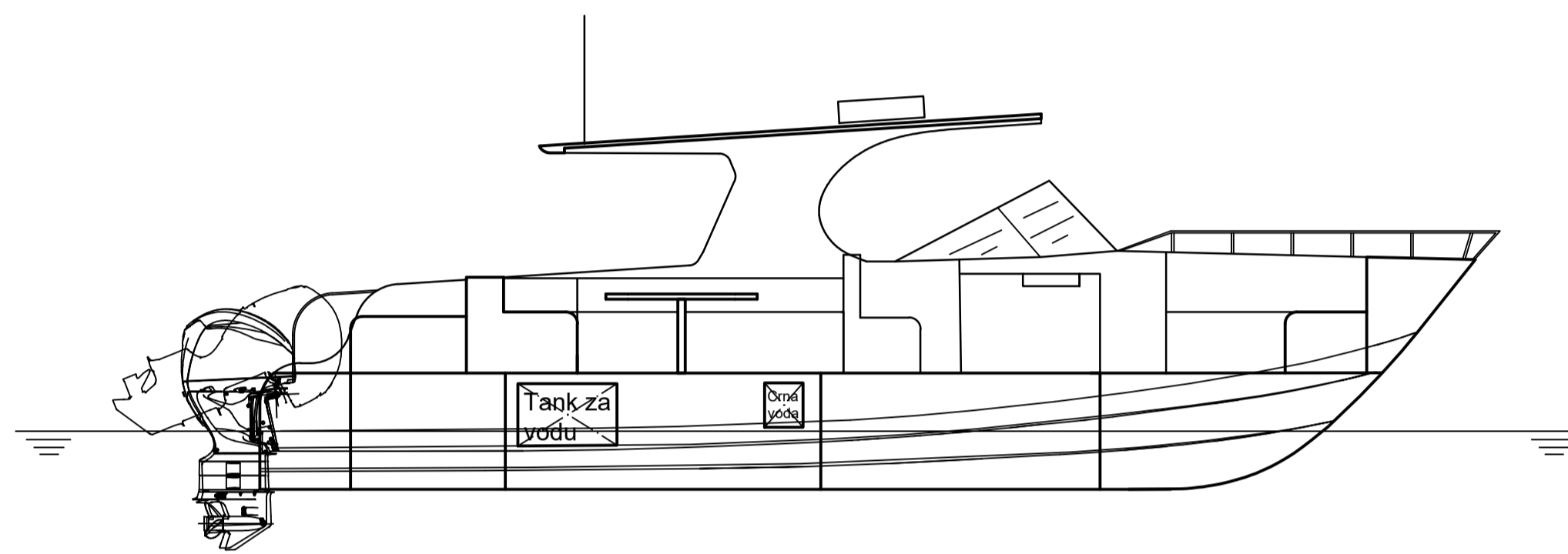

IZVEDBA 2. - S VANBRODSKIM PROPULZORIMA -  
POGLED NA DESNU STRANU

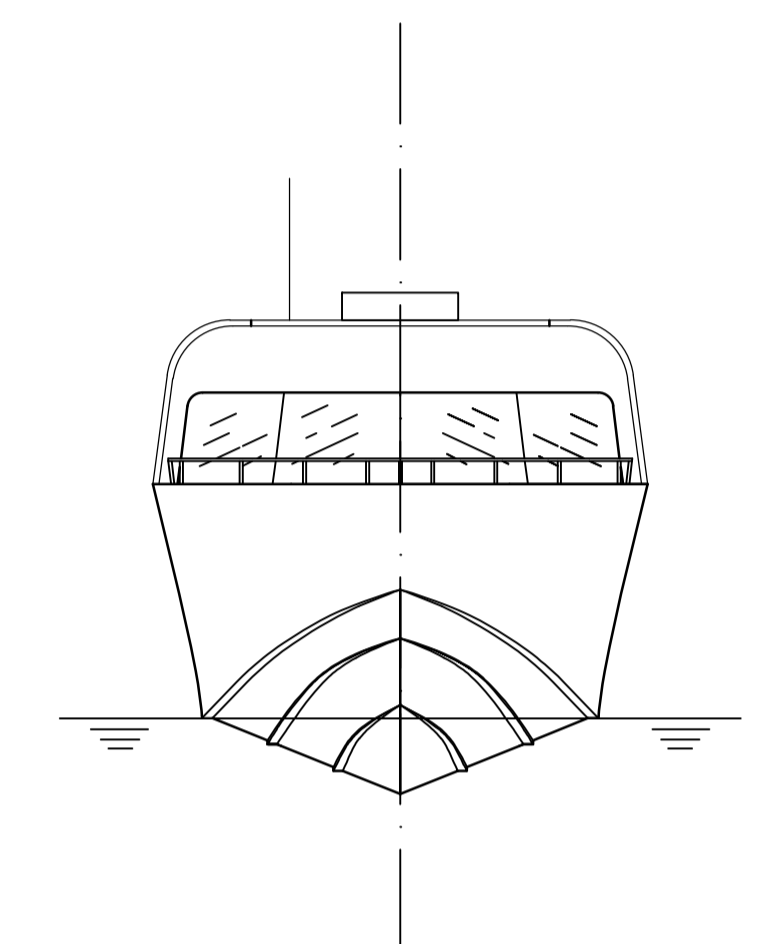

POGLED NA PRAMAC

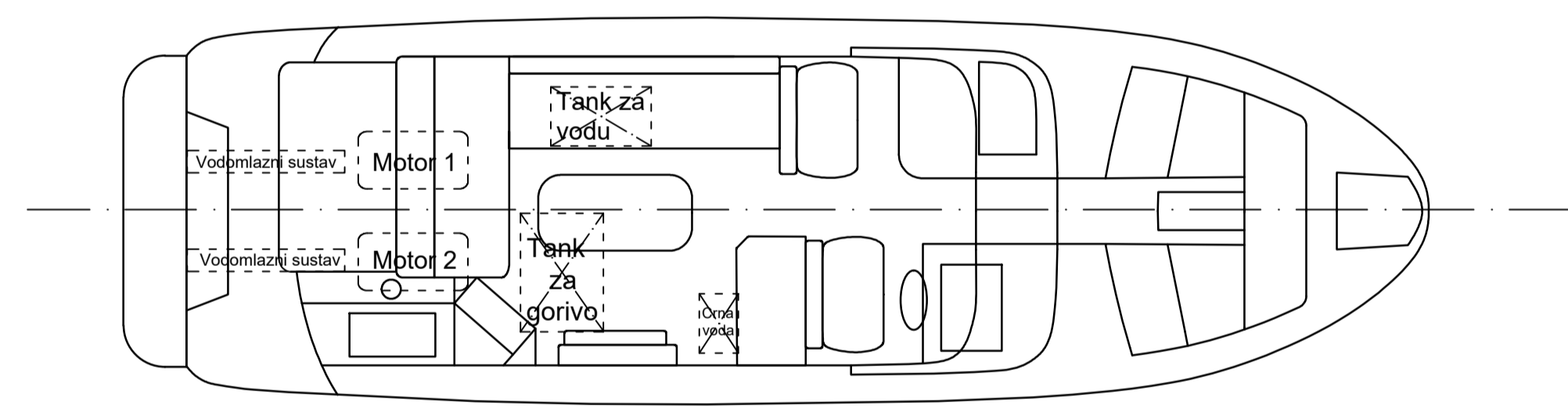

IZVEDBA 1. - S VODOMLAZNYM PROPULZORIMA -  
TLOCRT GLAVNE PALUBE

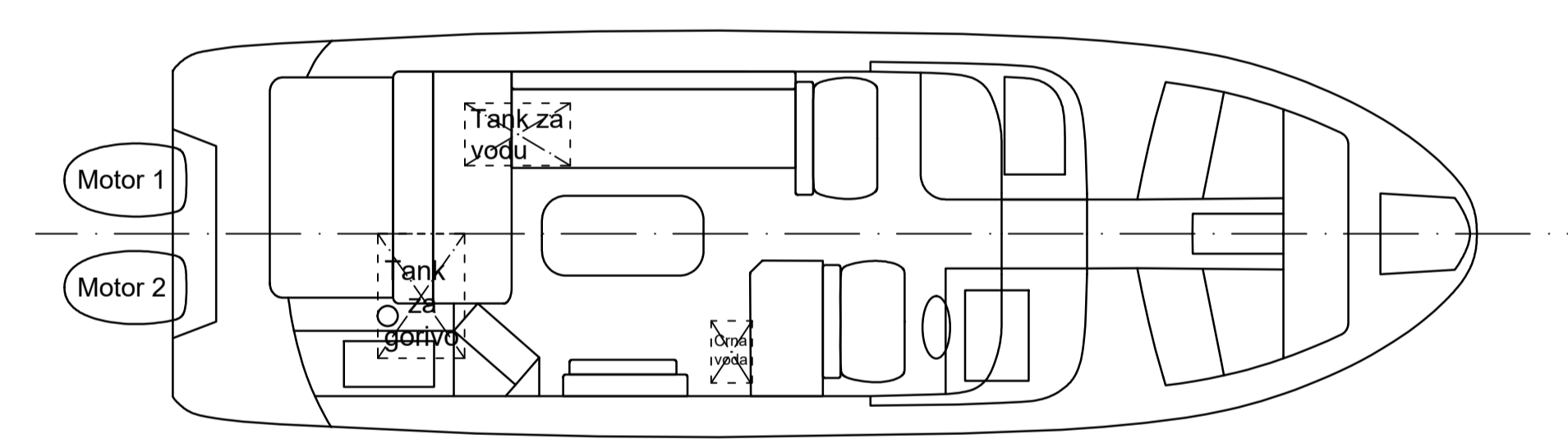

IZVEDBA 2. - S VANBRODSKIM PROPULZORIMA -  
TLOCRT GLAVNE PALUBE

**IKAS 105**

**GLAVNI PODACI**

*L<sub>0A</sub>* : ..... 10,5 m  
*B<sub>0A</sub>* : ..... 3,26 m  
*D<sub>0A</sub>* : ..... 2,05 m  
*T<sub>0A</sub> IZ. 1* : ..... 0,62 m  
*T<sub>0A</sub> IZ. 2* : ..... 0,57 m

DIPLOMSKI RAD	
SVEUČILIŠTE U RIJECI TEHNIČKI FAKULTET	MJERILO: M 1:50
OPĆI PLAN BRODA	
CRTAČ: IVAN KAŠKIĆ	DATUM:
PREGLEDAČ: ROKO DEJHALLA	12.09.2023.

PRILOG 3

PROJEKTNA NORMA EN ISO 12217-1:2017

B I C KATEGORIJA

IZVEDBA SA VODOMLAZNYM POGONSKIM SUSTAVOM

## ISO 12217-1:2017 NON-SAILING BOATS OF LENGTH GREATER THAN OR EQUAL TO 6m

Manufacturer:	Diplomski rad
Signatory, Name:	Ivan Kašikić
Signatory, Title:	Vodomlazni pogonski sustav
Phone:	
Email:	
WWW:	
CIN Model Year:	
Model Name:	IKAS 105

*This calculation sheet is provided by IMCI "as is" and any express or implied warranties, including, but not limited to, the implied warranties of fitness for a particular purpose are disclaimed.*

blue cells are derived values
-------------------------------

yellow cells require data input
---------------------------------

Please make sure to set your signature on the summary! (worksheet 12)  
either digitally or print summary, sign and attach scan

- most worksheets have additional comments / remarks / other calculations beside the printout area; please take into account.

- For boats in category A and B either fill in worksheet 6c and 6d or attach curve of righting moments for both loading conditions to the documentation.

- For boats with quick-draining cockpit the cockpit calculation according to ISO 11812 shall be enclosed to the documentation.

- Please attach other detailed information as appropriate, e.g. photos, sketches etc. for sill height, openings, companion way doors, location of flooding points, practical tests etc.

- When entering data, please use the correct separator for your Excel version, many application problems are the result of incorrect separators ( , or . )

- Please send questions, found errors, typos, mistakes, ect. directly to ralf.dewender@imci.org or to the headoffice with info@imci.org; every comment helps us to provides you with a better version

- Please be aware that there is NO technical difference between the requirements of ISO 12217-1:2015 and EN ISO 12217-1:2017; change of the name is just because of the harmonisation process; for ISO 12217-1:2020 the main change is the exclusion of optional equipment and margin for future additions from the maximum load and the result of the "maximum recommended load for builder's plate" (with ISO 14945:2021 and ISO 14946:2021 renamed to "maximum load for the builder's plate,  $m_{MBP}$ ") which exludes OB engine weights and the optional equipment.

**ISO 12217-1:2017 NON-SAILING BOATS OF LENGTH GREATER THAN OR EQUAL TO 6m  
CALCULATION WORKSHEET No. 1**

ISO 12217-1:2017 en220801

Diplomski rad IKAS 105

Design Category intended:	B	Monohull / Multihull:	Monohull	Propul.Type:	OB
Item	Symbol	Unit	Value	Ref.	
Length of hull as in ISO 8666	$L_H$	m	10,50		3.3.1
Length of waterline in loaded arrival condition	$L_{WL}$	m	9,26		3.3.2
<u>Empty Craft condition mass</u>	$m_{EC}$	kg	1831,0		3.4.1
standard equipment (incl. OB engine(s) and ess. safety equipment)		kg	2764,0		3.5.12
water ballast in tanks which are notified in the owner's manual to be filled when the boat is afloat		kg	0,0		3.4.2
Light craft condition mass	$m_{LC}$	kg	4595,0		3.4.2
<b>Mass of:</b>					
Desired crew limit	CL	----	10		3.5.3
Mass of:					
desired crew limit at 75 kg each		kg	750,0		
provisions + personal effects		kg	250,0		3.4.4
drinking water		kg	28,5		3.4.4
fuel		kg	304,0		3.4.4
lubricating and hydraulic oils		kg	19,0		3.4.4
black water		kg	47,5		3.4.4
grey water		kg	133,0		3.4.4
water ballast		kg	0,0		3.4.4
other fluids carried aboard		kg	28,5		3.4.4
stores, spare gear and cargo (if any)		kg	0,0		3.4.4
inflatable life raft(s) in excess of essential safety equipment		kg	0,0		3.4.4
other small boats carried aboard		kg	0,0		3.4.4
Maximum load = sum of above masses <b>using ISO ISO 12217-1:2020</b>	$m_L$	kg	1560,5		3.4.4
optional equipment and fittings not included in basic outfit		kg	0,0		3.4.4 / 3.4.5
Maximum load = sum of above masses <b>using ISO 12217-1:2017</b>	$m_L$	kg	1560,5		3.4.4
<u>Maximum Load condition mass</u>	$m_{LDC}$	kg	6155,5		3.4.5
Mass to be removed for loaded arrival condition		kg	505,8		3.4.6
<u>Loaded Arrival condition mass</u>	$m_{LA}$	kg	5649,8		3.4.6
Mass of:					
minimum number of crew weight according to 3.4.3		kg	150,0		3.4.3a)
non-consumable stores and equipment normally aboard		kg	50,0		3.4.3b)
inflatable life raft		kg			3.4.3
Load to be included in Minimum Operating Condition	$m'_L$	kg	200,0		3.4.3
<u>Light craft condition mass</u>	$m_{LC}$	kg	4595,0		3.4.2
Mass in the Minimum Operating Condition	$m_{MO}$	kg	4795,0		3.4.3
<u>Maximum load for the builder's plate using EN ISO 14946:2021 and EN ISO 14945:2021 (if manually reduced on Worksheet 1b the reduced value is shown)</u>	$m_{MBP}$	kg	1000,0		
<b>Is boat sail or non-sail?</b> Nominal sail area	$A_S^*$	m <sup>2</sup>	0,0		3.3.8
Sail area / displacement ratio = $A_S / (m_{LDC})^{2/3}$		----	0,0000		3.1.2
CLASSIFIED AS [non-sail if $A_S / (m_{LDC})^{2/3} < 0.07$ ]	SAIL/NON-SAIL ?		<b>NON-SAIL</b>		3.1.2
NB If NON_SAIL, continue using these worksheets, if SAIL, use ISO 12217-2					

## ISO 12217-1:2017 / ISO 14945:2021 CALCULATION WORKSHEET No.1b Builder's plate

Diplomski rad IKAS 105

Since 2021-12-09 EN ISO 14945:2021 and EN ISO 14946:2021 are harmonised!

The formerly 'Maximum recommended load for builder's plate' became '**Maximum load for the builder's plate**',  $m_{MBP}$ .

$m_{MBP}$  does not include the optional equipment anymore; also the weight of outboard engines is excluded from  $m_{MBP}$  and can be shown in a separated line on the plate.

Below you find two examples for the builder's plates with the maximum value for  $m_{MBP}$  calculated from the stability calculation on worksheet 1; one for craft powered by outboard engines, one for craft powered by inboard or sterndrive engines.

For portable tanks, please change the default 'yes' on the right side in 'no, portable tank'; the weight of the tank will be included in  $m_{MBP}$ .

Please be aware that ISO 14946:2021 allows in clause 6 that the maximum recommended load can be downrated or limited by the manufacturer at any time. Therefore you find an extra cell to enter a manual reduced value for the maximum load for the builder's plate.

Default outboard engine mass is calculated with the help of table F.1 from EN ISO 12217-1:2017; nevertheless the manufacturer can insert the actual engine mass the boat model is calculated with.

This is strongly recommended for engines with more than 164,2 kW which are outside the table range (means all 300, 350, 400, 450 and more HP outboard engines) !

Please be also aware that the design of these plates is just a proposal from EN ISO 14945, the manufacturer is free to change the design as long all requirements of the standard are fulfilled.

Item	Value	Unit	Ref.
Manually reduced value for the 'Maximum load for the builder's plate' $m_{MBP}$	1000	kg	EN ISO 14945, cl. 6, note 2
Maximum engine power of a single engine	230	kW	
Maximum number of engines	2		
Actual value of the max. outboard engine mass, (sum of all engines) as defined by the manufacturer and used for stability calculation (default value is table F.1 from ISO 12217-1:2017 value)	900	kg	EN ISO 12217-1:2017 table F.1

Please see builder's plate example with values calculated from worksheet 1 entries on next page:

Builder's plate information for craft powered by outboard engines -- Example

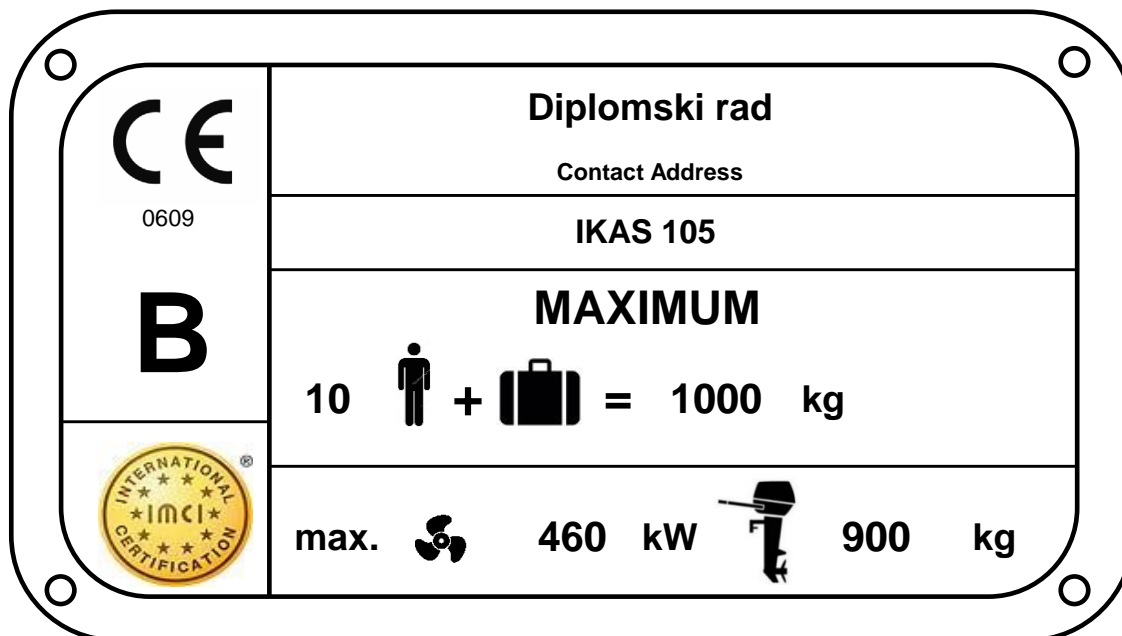

Builder's plate information for craft powered by inboard or sterndrive engines

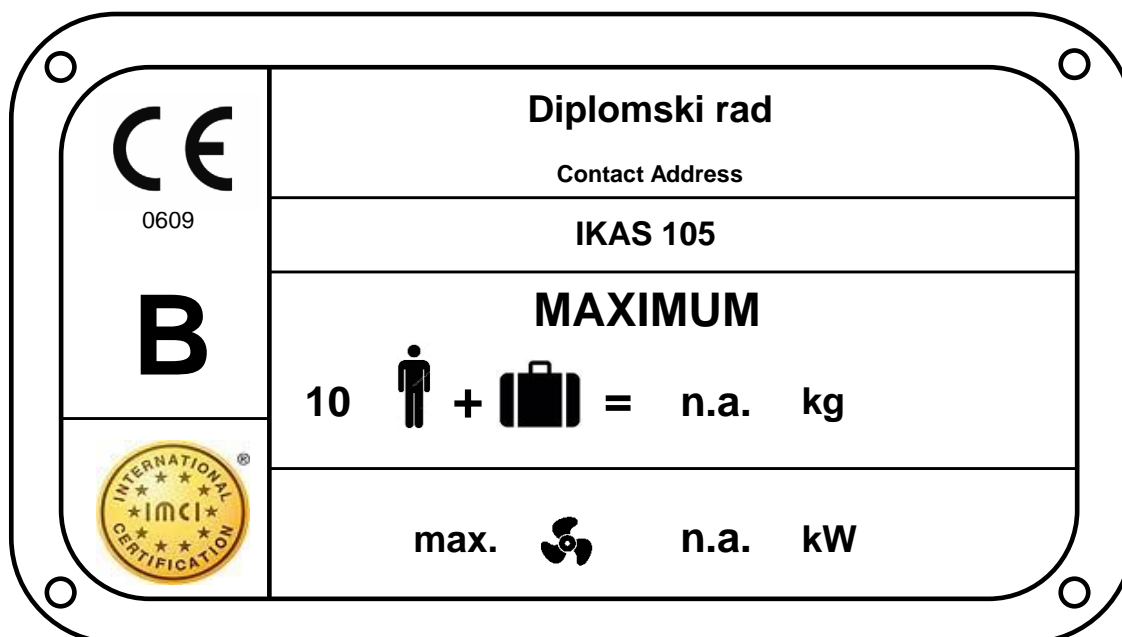



## ISO 12217-1:2017 CALCULATION WORKSHEET No.2 TESTS TO BE APPLIED

Diplomski rad IKAS 105

Question	Answer	Ref.
Is boat fully enclosed? (see definition in ref.) YES/NO?	Yes	3.1.6
Is boat partially protected? (see definition in ref.) YES/NO?	No	3.1.7

Item	Symbol	Unit	Value	Ref.
Windage area in minimum operating condition	$A_{LV}$	$m^2$	14,64	3.3.7
Length of Hull	$L_H$	m	10,50	3.3.2
Beam of hull	$B_H$	m	3,20	3.3.3
Freeboard at midships	$F_M$	m	1,48	3.3.5
Ratio $A_{LV}/(L_H B_H)$		---	0,44	

Choose any ONE of the following options and use all the worksheets indicated for that option.

Option	1	2	3	4	5	6
Categories possible	A and B	C and D	B	C and D	C and D	C and D
Decking or covering	fully enclosed	fully enclosed	any amount	any amount	partially protected	any amount
Downflooding openings	3	3	3	3	3	3
downflooding angle	3		3			
Downflooding height test	All boats	3	3	$3^a$	3	3
	Annex A method	4	4	$4^a$	4	4
Offset load test	5	5	5	5	5	5
Resistance to waves + wind	6		6			
Heel due to wind action		$7^b$		$7^b$	$7^b$	$7^b$
Recess size	8	$8^c$				$8^c$
Habitable multihulls	9	9	9	9	9	9
Motor sailers	9	9	9	9	9	9
Flotation test			10	10		
Flotation material			10	10		
Detection and removal of water	11	11	11	11	11	11
SUMMARY	12	12	12	12	12	12

a. The downflooding height test is not required to be conducted on the following Category C and D boats:  
 I. those which, when tested in accordance with normative annex F.4, have been shown to support, in addition to the mass required by F.2 and Table F.5, an additional equivalent dry mass (kg) of  $(75 \cdot CL + 10\%$  of dry weight of stores and equipment included in the maximum total load), or  
 II. those boats that do not take on water when heeled to  $90^\circ$  from the upright in the light craft condition.

b. The application of Worksheet 7 is only required for boats where  $A_{LV}/(L_H B_H) > 0,5$ .

c. Only required for boats of design category C; for option 6 clause 6.5.4 only

**Option selected**

**1**

## ISO 12217-1:2017 CALCULATION WORKSHEET No. 3 DOWNFLOODING

Diplomski rad IKAS 105

### Downflooding Openings:

Question	Answer	Ref.
Have all appropriate downflooding openings been identified?	Yes	3.2.1
Have potential downflooding openings within the boat been identified?	Yes	6.1.1.4
Do all closing appliances satisfy ISO 12216?	Yes	6.1.1.1
Hatches or opening type appliances are not fitted below minimum height above waterline? *	Yes	6.1.1.2
Seacocks comply with requirements?	Yes	6.1.1.3
Are all openings on design category A or B boats fitted with closing appliances? **	Yes	6.1.1.5
<b>Categories possible:</b> A or B if all are YES, C or D if first five are YES	<b>A</b>	6.1.1

\* Except for emergency escape hatches on design category C boats, where 0,1 m is allowable \*\* Except openings for ventilation and engine combustion

### Exemptions Downflooding Openings:

Question	Answer	Ref.
Drains from quick-draining recesses or watertight recesses acc. to cl. 6.1.1.6 b) are either:		
1) freeing ports with non-return flaps which are watertight from the exterior (degree 3) <b>or</b>		6.1.1.6 b)
2) have a drainage area smaller than three times the minimum area required of ISO 11812		6.1.1.6 b)
		6.1.1.6 b)
Opening appliances (e.g. side doors) in the topsides which comply with ISO 12216 are		
1) referenced in the owner's manual as watertight closure to be kept shut when under way, <b>and</b>		6.1.1.6 d)
2) marked inboard with "KEEP SHUT WHEN ..." in upper case letters not less than 4,8 mm high, <b>and</b>		6.1.1.6 d)
3) the height above waterline of the lowest part is > 50% of required downflooding height		6.1.1.6 d)
		6.1.1.6 d)
All other exemptions of cl. 6.1.1.6 checked and requirements fulfilled?		6.1.1.6
		6.1.1.6

### Downflooding angle (required for cat A & B only\*):

Item	Symbol	Unit	Value	Ref.
required Category A = larger of $(\phi_O + 25)^\circ$ or $30^\circ$	$\phi_{D(R)}$	degrees	n.a.	6.1.3; Table 3
( $\phi_O$ = angle from offset load test)				
required Category B = larger of $(\phi_O + 15)^\circ$ or $25^\circ$	$\phi_{D(R)}$	degrees	<b>25,00</b>	6.1.3; Table 3
Area of openings permitted to be submerged = $1.2 L_H B_H F_M$		cm <sup>2</sup>	<b>59,67</b>	6.1.3
<u>Actual downflooding angle:</u> at mass = $m_{MO}$	$\phi_{DA}$	degrees	<b>48</b>	6.1.3
at mass = $m_{LA}$	$\phi_{DA}$	degrees	<b>50</b>	6.1.3
Method used to determine $\phi_D$ :				Annex C
Design category possible on Downflooding Angle:			<b>B</b>	6.1.3

### Downflooding Height: (all exempt exempt boats)

Requirement		Basic requirement	Reduced value for small openings	Reduced value at outboard	Increased value at bow
Is boat exempted from downflooding height requirements according to 6.1.2.1?		Yes / No			
Applicable to		all options	all options (using figures)	options 3, 4 or 6	options 3, 4, 6
ref.		6.1.2.2 a)	6.1.2.2 d)	6.1.2.2 c)	6.1.2.2 b)
obtained from Figs. 3 + 4 or annex A?		<b>fig 3 &amp; 4</b>	= basic x 0.75	= basic x 0.80	= basic x 1.15
Maximum area of small openings ( $50L_H^2$ ) (mm <sup>2</sup> ) =			5513	////////	////////
Required downflooding height $h_{D(R)}$	Fig. 3/ann. A	Category A	<b>0,62</b>	<b>0,46</b>	<b>0,49</b>
	Fig. 3/ann. A	Category B	<b>0,62</b>	<b>0,46</b>	<b>0,49</b>
	Fig. 3/ann. A	Category C			
	Fig. 4/ann. A	Category D			
Actual Downflooding Height $h_D$			<b>1,56</b>	<b>1,56</b>	<b>1,56</b>
Design Category possible		<b>B</b>	<b>B</b>		
Design Category possible on Downflooding Height = lowest of above					<b>B</b>

## ISO 12217-1:2017 CALCULATION WORKSHEET No.3a DOWNFLOODING OPENINGS / CLOSING APPLIANCES

Diplomski rad IKAS 105

### General overview downflooding openings and closing appliances

**NOTE:** All drawings are not blocked by a password, so please replace with own drawings if at hand.

**NOTE:** See X, Y, Z coordinates for worksheet 3b as illustrated below

**Top View**

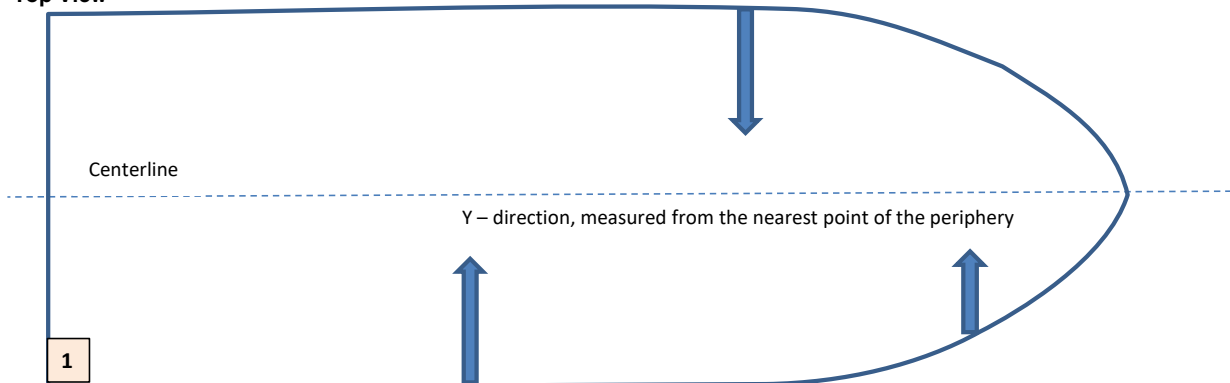

**Side View Starboard**

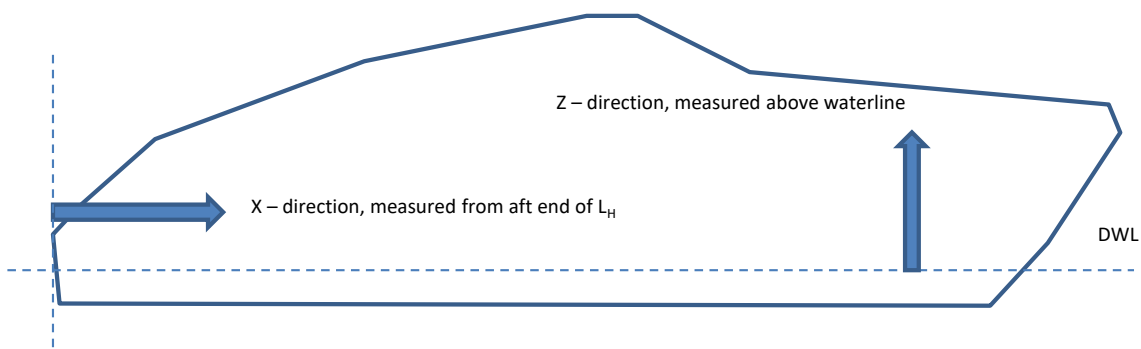

**Side View Port**

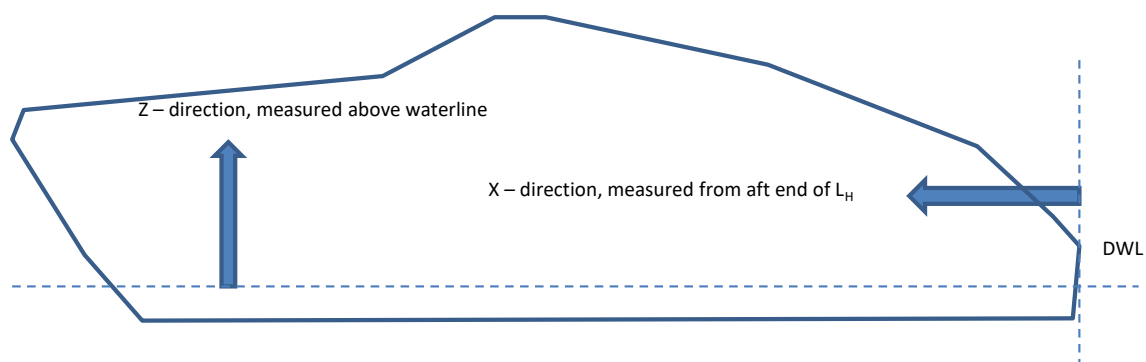

Please insert a short description and measurements of downflooding openings and closing appliances under the corresponding number on worksheet 3b

## ISO 12217-1:2017 CALCULATION WORKSHEET No.3b DOWNFLOODING OPENINGS

Diplomski rad IKAS 105

### General overview downflooding openings and closing appliances

**NOTE:** Please submit for every pre-fabricated closing appliance a declaration of conformity (DoC) of the product.  
Please submit for every non pre-fabricated closing appliance a calculation acc. to ISO 12216 (see IMCI template).  
For both a watertightness test must be done!

Description of the downflooding opening / closing appliance	Nr.	X <sup>(a)</sup> [m]	Y [m]	Z (=h <sub>D</sub> ) [m]	watertightness test done	opening type <sup>(b)</sup>
Razma	1	0,00	0,00	1,56	n.a.	downflooding opening
	2					
	3					
	4					
	5					
	6					
	7					
	8					
	9					
	10					
	11					
	12					
	13					
	14					
	15					
	16					
	17					
	18					
	19					
	20					
	21					
	22					

**(a)** Please be aware that X is measured from the aft end of L<sub>H</sub>.

In Annex A calculations x<sub>D</sub> is measured from the bow or stern, whichever is nearest

**(b)** opening types are: normal downflooding openings without any opening appliances; pre-fabricated opening appliances; non-pre-fabricated opening appliances and other devices

## ISO 12217-1:2017 CALCULATION WORKSHEET No.4 DOWNFLOODING HEIGHT

Diplomski rad IKAS 105

### Calculation using annex A

Item	Symbol	Unit	Opening 1	Opening 2	Opening 3	Opening 4
<b>Position of openings</b>						
Least longitudinal distance from bow/stern	$x_D$	m				
Least transvers distance from gunwale	$y_D$	m				
$F_1 = \text{greater of } (1 - x_D/L_H) \text{ or } (1 - y_D/B_H)$	$F_1$	----	1,00	1,00	1,00	1,00
<b>Size of openings:</b>						
Combined area of openings to top of any down-flooding opening	$a$	mm <sup>2</sup>				
Longitudinal distance of opening from tip of bow	$x'_D$	m				
Limiting value of $a = (30L_H)^2$		mm <sup>2</sup>	99225	99225	99225	99225
$\text{If } a \geq (30L_H)^2, F_2 = 1,0$ $\text{If } a < (30L_H)^2, F_2 = 1 + \frac{x'_D}{L_H} \left( \frac{\sqrt{a}}{75 L_H} - 0,4 \right)$	$F_2$	----	1,00	1,00	1,00	1,00
<b>Size of recesses:</b>						
Volume of recesses which are not self-draining in accordance with ISO 11812	$V_R$	m <sup>3</sup>				
Is opening not a recess? Is recess quickdraining? Is recess not quickdraining?						
$k = V_R/(L_H B_H F_M)$	$k$	----	0	0	0	0
If opening is not a recess, $F_3 = 1$						
If recess is quickdraining, $F_3 = 0.7$	$F_3$	----	1,20	1,20	1,20	1,20
If recess is not quick draining, $F_3 = (0.7 + k^{0.5})$						
<b>Displacement:</b>						
Loaded displacement volume (see 3.4.5)	$V_D$	m <sup>3</sup>	6,01			
$B = B_H$ for monohulls, $B_{WL}$ for multihulls	$B$	m	3,2			
$F_4 = [(10 V_D)/(L_H B^2)]^{1/3}$	$F_4$	----	0,82			
<b>Flotation:</b>						
For boats using option 3 or 4, $F_5 = 0.8$						
For all other boats, $F_5 = 1.0$	$F_5$	----	1			
<b>Required calculation height: <math>= F_1 F_2 F_3 F_4 F_5 L_H / 15</math></b>	$h_{D(R)}$	m	0,69	0,69	0,69	0,69
Required downflooding height with limits applied (see annex A, Table A.1)	Category A	$h_{D(R)}$				
	Category B	$h_{D(R)}$	0,4	0,4	0,4	0,4
	Category C	$h_{D(R)}$				
	Category D	$h_{D(R)}$				
<b>Measured Downflooding Height:</b>	$h_D$	m				
<b>Design Category possible:</b>						
<b>Lowest of above =</b>						<b>Fail</b>

ISO 12217-1:2017 CALCULATION WORKSHEET - No. 5a

OFFSET LOAD TEST

Diplomski rad IKAS 105

Mass of people used for test

Name	Ident.	Mass (kg)
Person 1	A	85
Person 2	B	85
Person 3	C	85
Person 4	D	85
Person 5	E	85
Person 6	F	85
Person 7	G	85
Person 8	H	85
Person 9	I	85
Person 10	J	85

downflooding opening obvious to the crew?  Yes

Crew Area

Areas included and access limitations (if any):

Area	P/S	Incl?	Persons limit
Main Cockpit			
Aft Cockpit			
Fwd Cockpit			
Salon			
Cabins			
Side Decks			
Fore Deck			

Offset Load Test

Name	Ident.	Mass (kg)
Person 11	K	
Person 12	L	
Person 13	N	
Person 14	M	
Person 15	O	
Person 16	P	
Person 17	Q	
Person 18	R	
Person 19	S	
Person 20	T	

average mass per person:   
 number of persons permitted (through offset load test)

Area	P/S	Incl?	Persons limit
Cuddy Top			
Coachroof Top			
Wheelhouse Top			
Fly Bridge			
Swim Platform			

**Sketch:** Indicate possible seating locations along the length of the side to be tested using numbers, so that these may later be used to record the positions that people actually occupy. Locations should not be closer than 0.5 m between centers, and not less than 0.2 m from outboard edge unless on sidedecks less than 0.4 m wide.

1) Note whether it is asymmetric by adding P (port) or S (starboard) to denote the larger side.

**ISO 12217-1:2017 CALCULATION WORKSHEET - No. 5b**
**OFFSET-LOAD TEST**

Diplomski rad IKAS 105

**Stability Test - Full Procedure**

Boat being tested for:		x	stability	x	downflooding			please mark	
$L_H$ (m)	Min. permitted freeboard margin (m) (see Table 5)		Max. permitted heel angle (°) $= 11,5 + \frac{(24 - LH)^3}{520}$		Intended crew limit (CL)	Intended design category	Mass Test weights per person (kg) (Cat D only)	Max. Mass of test weights (kg) (= 98 x CL)	
10,50	n.a.		16,23		10	B		980	
Does boat have a list?		No		If "YES" to which side?					
Is crew area asymmetric?		Yes		If "YES" to which side?					
Is downflooding asymmetric?		No		If "YES" to which side?					
Boat tested:		to Port							

**Test Data:**

Mass ident.	Location		Mass (kg)	Total mass (kg)	Lever (m)	Moment (kg-m)	Heel angle (°) P/S	min. freeb'd (m)	
	area	fore & aft						fwd	aft
1			85	85	0,32	26,78			
2			85	170	0,13	11,05			
3			85	255	0,85	72,25			
4			85	340	0,82	69,70			
5			85	425	1,12	95,20			
6			85	510	0,82	69,70			
7			85	595	0,75	63,75			
8			85	680	0,75	63,75			
9			85	765	0,69	58,65			
10			85	850	0,69	58,65	2,00	0,15	0,15
11				850		0,00			
12				850		0,00			
13				850		0,00			
14				850		0,00			
15				850		0,00			
16				850		0,00			
17				850		0,00			
18				850		0,00			
19				850		0,00			
20				850		0,00			

total:	$\Sigma$	max. angle	min freeboard	
	589,48	2,00	0,15	0,15

Max. mass of people allowed per above:	850	hence CL =	10	at	85	kg / person
--	-----	------------	----	----	----	-------------

Design category given:	B
------------------------	---

Safety Signs Required:	Fig B1:	No	Fig B2:	No	Fig B3:	No
------------------------	---------	----	---------	----	---------	----

## ISO 12217-1:2017 CALCULATION WORKSHEET No. 5c Simplified procedure for OFFSET LOAD TEST

Diplomski rad IKAS 105

This method may only be applied by calculation; requirements must be fulfilled for both conditions LC1 and LC2

### Preparation (curves of moments in Nm)

Question	Answer	ref.
Mass and the centre-of-gravity of the boat calculated for conditions LC1 and LC2?		B.3.2.2
Curves of righting moments calculated according to annex E?		B.3.2.3
Crew heeling moment curve calculated with $961 CL (B_C/2 - 0,2) \cos \phi$ or where the crew area includes side decks less than 0,4m wide with $480 CL BC \cos \phi$ ?		B.3.2.4

### Test data:

item	symbol	unit	LC1	LC2	ref.
Maximum transverse distance between the outboard extremities of any part of the crew area	$B_C$	m			B.3.2.4 & B.3.1.7
Heel angle at the point of intersection between crew heeling moment curve and the curve of righting moment	$\phi_O$	degrees	0,00	0,00	B.3.2.5
Maximum permitted heel angle	$\phi_{O(R)}$	degrees	16,23		B.3.2.5
Value of downflooding angle	$\phi_{DA}$	degrees			B.3.2.5
Value of minimum freeboard margin at $\phi_O$	$h_F$	m			
Minimum required freeboard margin	$h_{F(R)}$	m	n.a.		6.2.2 table 4
Max. righting moment up to $\phi_{DA}$		Nm	#VALUE!	#VALUE!	
Crew heeling moment at $\phi_O$		Nm	FALSE	FALSE	

### Requirements:

Question	Answer	ref.
Is $\phi_O < \phi_{O(R)}$	Fail	B.3.2.5
Is $h_F > h_{F(R)}$	n.a.	B.3.2.5
Is the max. righting moment up to $\phi_{DA} >$ crew heeling moment at $\phi_O$ ?	#VALUE! #VALUE!	B.3.2.5
Offset load test passed, if all questions above are answered with 'yes' (or n.a.)	Pass/Fail #VALUE!	B.3.2.5



**ISO 12217-1:2017 CALCULATION WORKSHEET No. 5d curve of righting moment LC1**

Diplomski rad IKAS 105

insert curve of righting moment in 5° steps in one of following units:

**OFFSET LOAD TEST**

<b>N m</b>	<b>kg m</b>	<b>m</b>	<b>mLC1</b>	5975,25
<input type="checkbox"/> chosen unit <input type="checkbox"/> crew heeling moment curve (either normal or if side decks smaller 0,4m)				

heel angle [°]	insert righting arm / moment [Nm, kg m, m]	righting moment [Nm]	righting moment [kg m]	righting arm Gz [m]	crew heeling moment curve [N m]
0		#VALUE!	#VALUE!	error	FALSE
5		#VALUE!	#VALUE!	error	FALSE
10		#VALUE!	#VALUE!	error	FALSE
15		#VALUE!	#VALUE!	error	FALSE
20		#VALUE!	#VALUE!	error	FALSE
25		#VALUE!	#VALUE!	error	FALSE
30		#VALUE!	#VALUE!	error	FALSE
35		#VALUE!	#VALUE!	error	FALSE
40		#VALUE!	#VALUE!	error	FALSE
45		#VALUE!	#VALUE!	error	FALSE
50		#VALUE!	#VALUE!	error	FALSE

point of intersection of righting moment curve and crew heeling moment curve

$\Phi_c$

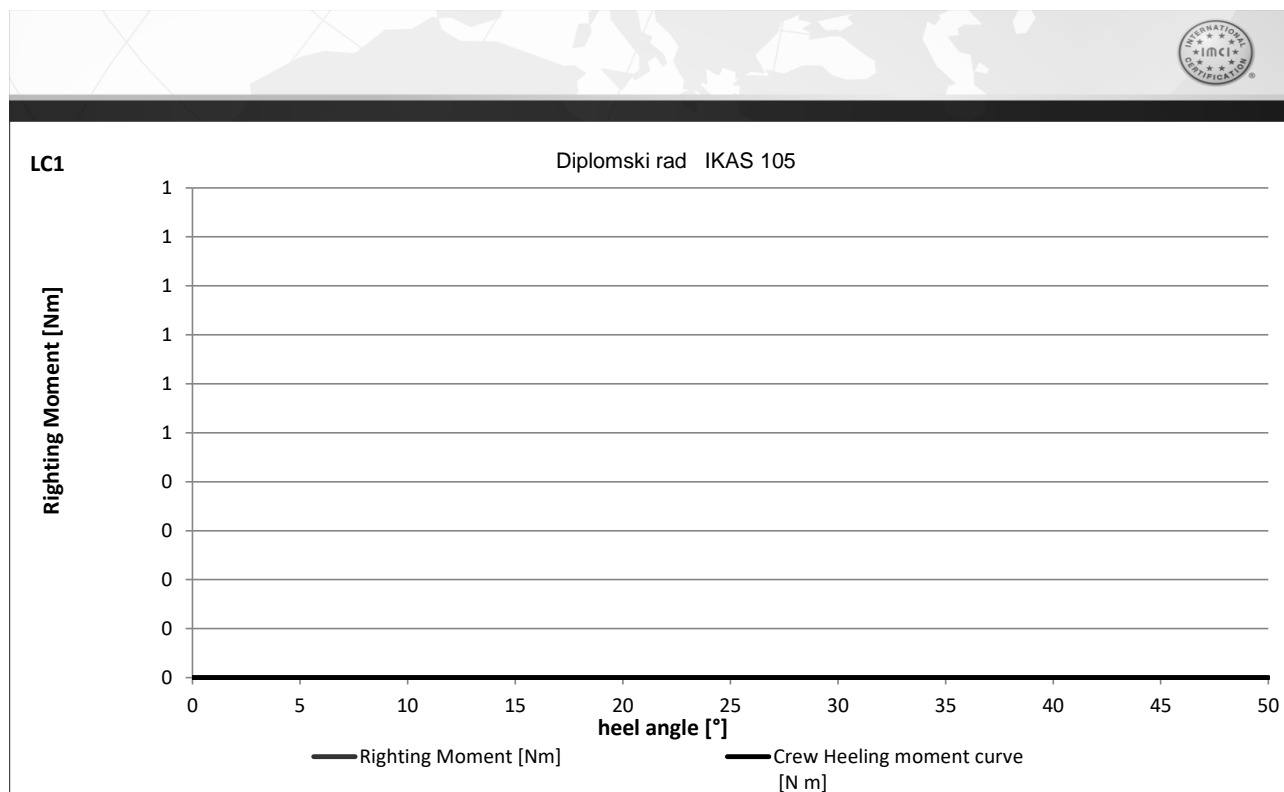



ISO 12217-1:2017 CALCULATION WORKSHEET No. 5e curve of righting moment LC2

Diplomski rad IKAS 105

insert curve of righting moment in 5° steps in one of following units:

OFFSET LOAD TEST

*N m*      *kg m*      *m*

*mLC2*     

chosen unit

crew heeling moment curve (either normal or if side decks smaller 0,4m)

heel angle [°]	insert righting arm / moment [Nm, kg m, m]	righting moment [Nm]	righting moment [kg m]	righting arm Gz [m]	crew heeling moment curve [N m]
0		#VALUE!	#VALUE!	error	FALSE
5		#VALUE!	#VALUE!	error	FALSE
10		#VALUE!	#VALUE!	error	FALSE
15		#VALUE!	#VALUE!	error	FALSE
20		#VALUE!	#VALUE!	error	FALSE
25		#VALUE!	#VALUE!	error	FALSE
30		#VALUE!	#VALUE!	error	FALSE
35		#VALUE!	#VALUE!	error	FALSE
40		#VALUE!	#VALUE!	error	FALSE
45		#VALUE!	#VALUE!	error	FALSE
50		#VALUE!	#VALUE!	error	FALSE

point of intersection of righting moment curve and crew heeling moment curve

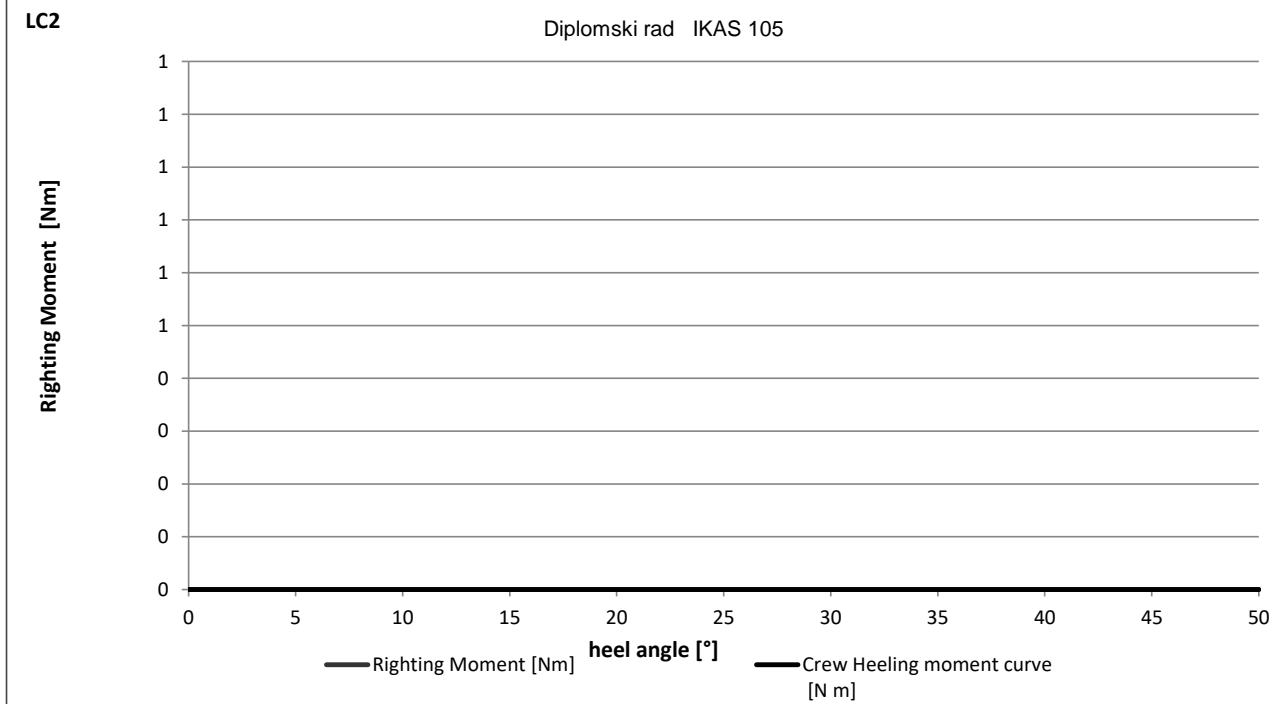

**ISO 12217-1:2017 CALCULATION WORKSHEET No. 6a RESISTANCE TO WAVES+WIND**

Diplomski rad IKAS 105

**Input data:**

**Design categories A and B only**

Item	Symbol	Unit	$m_{LA}$	$m_{MO}$	Ref.
Mass in minimum operating condition	$m_{MO}$	kg		4795,00	3.4.3
Loaded arrival mass	$m_{LA}$	kg	5649,75		3.4.6
Displacement volume (= $m_{MO}/1025$ or $m_{LA}/1025$ )	$V_D$	m <sup>3</sup>	5,51	4,68	3.4.7
Windage area (of above water profile of boat)	$A_{LV}$	m <sup>2</sup>	14,26	14,64	3.3.7
Windage area to be used (not to be < 0.5 $L_H B_H$ )	$A'_{LV}$	m <sup>2</sup>	16,80	16,80	6.3.2
Length waterline	$L_{WL}$	m	9,26	8,96	3.3.2
Lever between centroids of above and below water areas	$h$	m	1,03	1,04	6.3.2
Draught of canoe body at the mid-point of the waterline length	$T_M$	m	0,59	0,55	
Downflooding angle	$\phi_{DA}$	degrees	50	48	3.2.2
Calculation windspeed	$v_W$	m/s	21	21	3.5.1

**ISO 12217-1:2017 CALCULATION WORKSHEET No. 6b RESISTANCE TO WAVES+WIND**

Diplomski rad IKAS 105

Rolling in beam waves and wind:

Design categories A and B only

Item	Symbol	Unit	m <sub>LA</sub>	m <sub>MO</sub>	Ref.
Second wind heel equilibrium angle		degrees	66,4	63,3	Fig. 6
Least value of $\phi_{DA}$ , 50° or second wind heel equilibrium angle	$\phi_{A2}$	degrees	50,0	48,0	Fig. 6
Wind heeling moment (1) = $0.53 A'_{LV} h v_W^2$	$M_{W1}$	N-m	4044	4084	6.3.2
Wind heeling moment (2) = $0.30 A'_{LV} (A'_{LV} / L_{WL} + T_M) v_W^2$	$M_{W2}$		5344	5390	
Assumed roll angle Category A = $(25+20/V_D)$	$\phi_R$	degrees	23,6	24,3	6.3.2
Category B = $(20+20/V_D)$					
Area 1 (see fig. 6)	$A_1$	any	3,14	3,62	Fig. 6
Area 2 (see fig. 6)	$A_2$	any	6,06	4,71	Fig. 6
Ratio of $A_2/A_1$		--	1,93	1,30	6.3.2
Is ratio of $A_2/A_1$ greater than or equal to 1.0?	YES / NO		YES	YES	6.3.2

Resistance to waves:

Item	Symbol	Unit	m <sub>LA</sub>	m <sub>MO</sub>	Ref.
Least value of $\phi_{DA}$ , 50° or second wind heel equilibrium angle		degrees	50,00	48,00	6.3.3
Heel angle when righting moment is maximum	$\phi_{GZMax}$	degrees	65,00	65,00	6.3.3
<b>IF <math>\phi_{GZMax}</math> is greater than or equal to 30°</b>					
Max value of righting moment @ 30° heel?	$RM_{30}$	kN m	11,52	9,69	6.3.3a)
Required value of righting moment		kN m	7,00	7,00	6.3.3a)
Is $RM_{30}$ greater than or equal to required max value?			PASS	PASS	6.3.3b)
Value of righting lever at 30° = $RM_{30}/(9.806*mass)$	$GZ_{30}$	m	0,208	0,206	3.5.10
Required value of righting lever at 30°		m	0,20	0,20	6.3.3a)
Is $GZ_{30}$ greater than or equal to required max value?			PASS	PASS	6.3.3a)
<b>IF <math>\phi_{GZMax}</math> is less than 30°</b>					
Max value of righting moment	$RM_{MAX}$	kN m	25,26	23,65	6.3.3b)
Required value of $RM_{MAX}$ ( $A = 750/\phi_{GZMax}$ , $B = 210/\phi_{GZMax}$ )		kN m	3,23	3,23	6.3.3b)
Is $RM_{MAX}$ greater than or equal to required max value?			n.a.	n.a.	6.3.3b)
Max value of righting lever = $RM_{MAX}/(9.806*mass)$	$GZ_{Max}$	m	0,45600	0,50300	3.5.10
Required max value of righting lever = $6/\phi_{GZMax}$		m	n.a.	n.a.	6.3.3b)
Is $GZ_{MAX}$ greater than or equal to the required max value? PASS / FAIL			n.a.	n.a.	6.3.3b)

**Design Category given: NB:** Boat must have ratio of  $A_2/A_1$  greater than or equal to 1.0, and also get PASS twice under resistance to waves.

**B**

**ISO 12217-1:2017 CALCULATION WORKSHEET No. 6c curve of righting moment  $m_{LA}$**

Diplomski rad IKAS 105

insert curve of righting moment in 5° steps in one of following units:

chosen unit	<b>N m</b>	<b>kg m</b>	<b>m</b>
	<b>m</b>		
chose of $M_w$	<b>MW1</b>		

heel angle [°]	insert Righting Arm/Moment [Nm, kg m, m]	Righting Moment [Nm]	Righting Moment [kg m]	Arm Gz [m]	Wind Heeling moment curve [m]
-25	-0,165	-9.141	-932	-0,165	0,0730
-20	-0,147	-8.144	-831	-0,147	0,0730
-15	-0,124	-6.870	-701	-0,124	0,0730
-10	-0,093	-5.152	-525	-0,093	0,0730
-5	-0,048	-2.659	-271	-0,048	0,0730
0	0,014	776	79	0,014	0,0730
5	0,077	4.266	435	0,077	0,0730
10	0,121	6.704	684	0,121	0,0730
15	0,151	8.366	853	0,151	0,0730
20	0,174	9.640	983	0,174	0,0730
25	0,192	10.637	1.085	0,192	0,0730
30	0,208	11.524	1.175	0,208	0,0730
35	0,228	12.632	1.288	0,228	0,0730
40	0,253	14.017	1.429	0,253	0,0730
45	0,292	16.177	1.650	0,292	0,0730
50	0,363	20.111	2.051	0,363	0,0730
55	0,425	23.546	2.401	0,425	0,0730
60	0,455	25.208	2.571	0,455	0,0730
65	0,456	25.263	2.576	0,456	0,0730
70	0,436	24.155	2.463	0,436	0,0730

**area A1 and A2 limits**

heel degrees		heel degrees	
A1 from	-18,95	to	4,68
A2 from	4,68	to	50,00
			below $M_w$
			above $M_w$

**point of intersection of righting moment curve and wind heeling moment curve**

$\Phi_w$
4,683

$M_w$	4044	Nm
$M_w$	412,4	kg m
$M_w$	0,073	m
$\Phi_w$	4,68	degrees
$\Phi_{A2}$	50,00	degrees
$\Phi_R$	23,63	degrees

Max $m_{LA}$	0,456	m
heel at GZ max	65,00	degrees

**INTERNATIONAL MARINE CERTIFICATION INSTITUTE**  
INTERNATIONAL NON-PROFIT ASSOCIATION



Heeling arm curve  $m_{LA}$

Diplomski rad IKAS 105

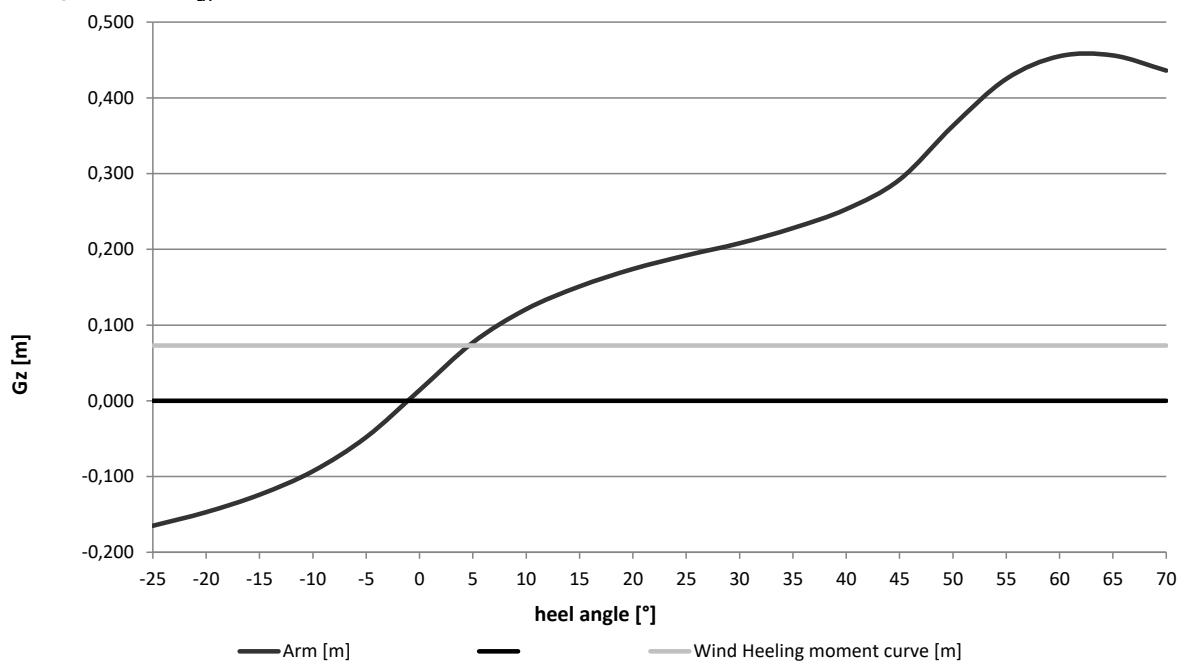

**ISO 12217-1:2017 CALCULATION WORKSHEET No. 6d curve of righting moment  $m_{MO}$**

Diplomski rad IKAS 105

insert curve of righting moment in 5° steps in one of following units:

	<b>N m</b>	<b>kg m</b>	<b>m</b>
chosen unit	m		
chose of $M_w$	MW1		

heel angle [°]	insert Righting Arm/Moment [Nm, kg m, m]	Righting Moment [Nm]	Righting Moment [kg m]	Arm Gz [m]	Wind Heeling moment curve [m]
-25	-0,23	-10.815	-1.103	-0,230	0,0869
-20	-0,208	-9.780	-997	-0,208	0,0869
-15	-0,181	-8.511	-868	-0,181	0,0869
-10	-0,145	-6.818	-695	-0,145	0,0869
-5	-0,096	-4.514	-460	-0,096	0,0869
0	-0,026	-1.223	-125	-0,026	0,0869
5	0,044	2.069	211	0,044	0,0869
10	0,093	4.373	446	0,093	0,0869
15	0,13	6.113	623	0,130	0,0869
20	0,159	7.476	762	0,159	0,0869
25	0,183	8.605	877	0,183	0,0869
30	0,206	9.686	988	0,206	0,0869
35	0,232	10.909	1.112	0,232	0,0869
40	0,265	12.460	1.271	0,265	0,0869
45	0,311	14.623	1.491	0,311	0,0869
50	0,378	17.773	1.813	0,378	0,0869
55	0,452	21.253	2.167	0,452	0,0869
60	0,492	23.134	2.359	0,492	0,0869
65	0,503	23.651	2.412	0,503	0,0869
70	0,492	23.134	2.359	0,492	0,0869

**area A1 and A2 limits**

heel degrees		heel degrees	
A1 from	-14,90	to	9,37
A2 from	9,37	to	48,00

below  $M_w$   
above  $M_w$

**point of intersection of righting moment curve and wind heeling moment curve**

$\Phi_w$
9,373

$M_w$	4084	Nm
$M_w$	416,5	kg m
$M_w$	0,087	m
$\Phi_w$	9,37	degrees
$\Phi_{A2}$	48,00	degrees
$\Phi_R$	24,28	degrees

Max $m_{MO}$	0,503	m
heel at GZ max	65,00	degrees

**INTERNATIONAL MARINE CERTIFICATION INSTITUTE**  
INTERNATIONAL NON-PROFIT ASSOCIATION



Heeling arm curve  $m_{Mo}$

Diplomski rad IKAS 105

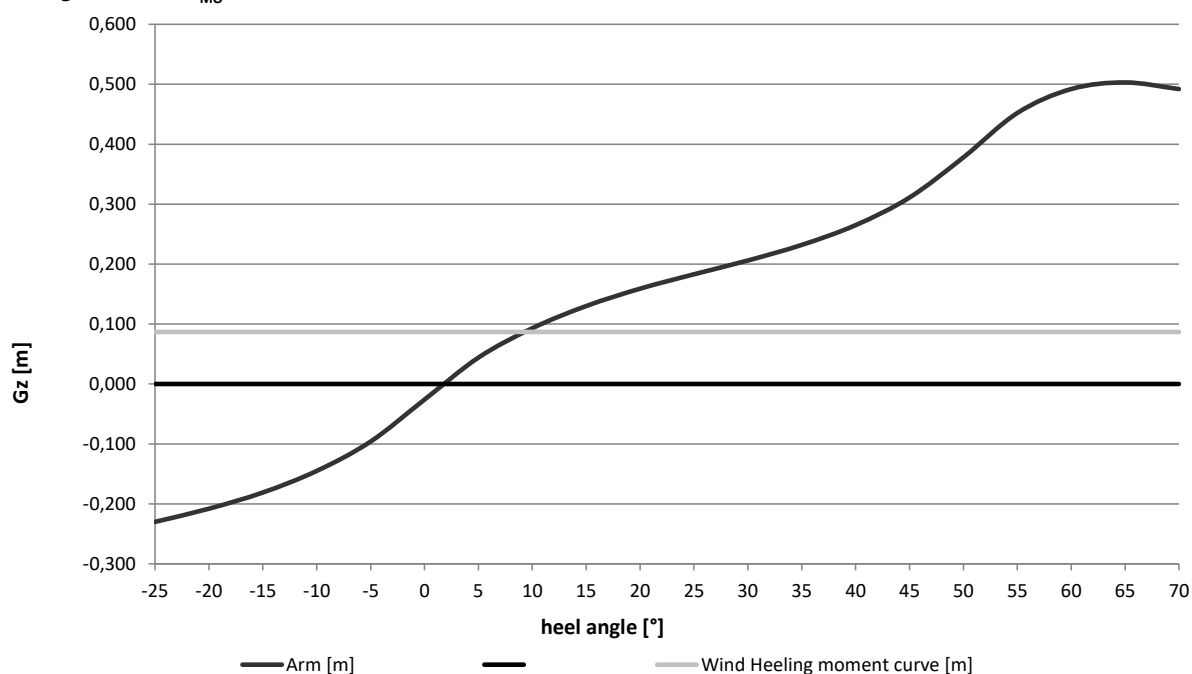



ISO 12217-1:2017 CALCULATION WORKSHEET No.7

HEEL DUE TO WIND ACTION

Diplomski rad IKAS 105

**NB: This sheet is to be completed for both Minimum Operating and Loaded arrival condition**

Initial check:

Design Categories C and D only

Item	Symbol	Unit	m <sub>LA</sub>	m <sub>MO</sub>	Ref.
Windage area (NOT subject to minimum of 0.5 L <sub>H</sub> B <sub>H</sub> )	A <sub>LV</sub>	m <sup>2</sup>		14,64	3.3.7
Length of Hull	L <sub>H</sub>	m	10,50	10,50	3.3.2
Beam of hull	B <sub>H</sub>	m	3,20		3.3.3
Ratio A <sub>LV</sub> /(L <sub>H</sub> B <sub>H</sub> ) at m <sub>MO</sub>		-----	0,44		
Is ratio A <sub>LV</sub> /(L <sub>H</sub> B <sub>H</sub> ) equal to or greater than 0.5?			No		6.4
If answer is NO, no other assessment is required.					

Calculation of wind heeling moment:

Item	Symbol	Unit	m <sub>LA</sub>	m <sub>MO</sub>	Ref.
Length of waterline	L <sub>WL</sub>	m			3.3.2
Draught at the mid-point of L <sub>WL</sub>	T <sub>M</sub>	m			6.3.2
Lever between centroids of above and below water areas	h	m			6.3.2
Calculation wind speed	v <sub>W</sub>	m/s	n.a.		3.5.1
Wind heeling moment M <sub>W1</sub> = 0.53 A <sub>LV</sub> h v <sub>W</sub> <sup>2</sup>	M <sub>W</sub>	Nm	#VALUE!	#VALUE!	6.4.2
Wind heeling moment M <sub>W2</sub> = 0.3 A <sub>LV</sub> (A <sub>LV</sub> / L <sub>WL</sub> + T <sub>M</sub> ) v <sub>W</sub> <sup>2</sup>	M <sub>W</sub>	Nm	#DIV/0!	#DIV/0!	6.4.2

Angle of heel due to wind:

Item	Symbol	Unit	m <sub>LA</sub>	m <sub>MO</sub>	Ref.
FROM RIGHTING MOMENT CURVE: angle of heel due to wind	φ <sub>W</sub>	degrees	4,68	9,37	6.4.3
OR ALTERNATIVELY: wind heeling moment M <sub>W</sub> divided by 9.806	M <sub>W</sub>	kg.m	#VALUE!	#VALUE!	
Angle of heel due to wind when moment above applied	φ <sub>W</sub>	degrees			6.4.3
Maximum permitted angle of heel during offset load test (from worksheet 5b)	φ <sub>O(R)</sub>	degrees	16,23		6.2.3
Downflooding angle	φ <sub>DA</sub>	degrees	50	48	3.2.2
Maximum permitted angle of heel due to wind = lesser of 0.7φ <sub>O(R)</sub> and 0.7φ <sub>DA</sub>		degrees	11,4	11,4	6-4.3
Is angle of heel due to wind less than permitted value?			Pass	Pass	6.4.3
<b>Design Category possible on wind heeling =</b>					

**ISO 12217-1:2017 CALCULATION WORKSHEET No. 8**

Diplomski rad IKAS 105

**NB: This sheet is to be completed for the Loaded Arrival Condition.**

**calculation required**

Please submit multiple copies of this page if applicable

		Recess	Ref.
<b>Further exemptions according to 6.5.1</b>			
Angle of vanishing stability > 90° ?	YES/NO	Yes	6.5.1a)
Over at least 35% of the periphery is the depth of the recess less than 3% of the max. breadth of the recess (e.g. toe rails, low bulwarks)	YES/NO		6.5.1b)
At least 5% of the bulwark area positioned within the lowest 25% of the bulwark height drains overboard and the bulwark height is less than 12,5% of the maximum breadth of the recess <i>(attention, req. 1) and 2) below must get also a "Yes" to fulfill all requirements)</i>	YES/NO		6.5.1c)
Unobstructed drainage area from the recess on each side of the boat centreline	m <sup>2</sup>		6.5.1d)
Volume of the recess to the recess retention level	m <sup>3</sup>		
Drainage area per side (m <sup>2</sup> ) divided by recess volume (m <sup>3</sup> )			6.5.1d)
Height position of drainage area (lowest 25% / lowest 50% / full depth)			6.5.1d)
Requirements of 6.5.1.d) fulfilled? <i>(attention, req. 1) and 2) below must get also a "Yes"</i>	YES/NO		6.5.1d)
1) the lower edge of the drainage openings are not more than 10 mm above recess sole height for at least 70 % of the width of each opening?	YES/NO	Yes	6.5.1 c) & d)
2) If drainage area is provided by an open or partially open transom, are the openings extend to the outboard sides of the recess sole on both sides?	YES/NO	Yes	6.5.1 c) & d)
Is recess exempt from size limit? If "yes", no further calculation required.	Yes		6.5.1

**Calculation methods:**

Item	Symbol	Unit	Value	Ref.
			Recess	
<b>SIMPLIFIED METHOD: Use 1), 2) or 3) below.</b>				
Average freeboard to loaded waterline at aft end of recess	$F_A$	m		6.5.2.1
Average freeboard to loaded waterline at sides of recess	$F_S$	m		6.5.2.1
Average freeboard to loaded waterline at forward end of recess	$F_F$	m		6.5.2.1
Waterline length at mLA	$L_{WL}$	m		
Waterline breadth at mLA (for multihulls insert max. beam waterline $B_{WLmax}$ acc. to ISO 8666)	$B_{WL}/B_{WLmax}$	m		ISO 8666 4.3.4/5
Maximum length of recess at the retention level (see 3.5.11)	$l$	m		6.5.2.4
Maximum breadth of recess at the retention level (see 3.5.11)	$b$	m		6.5.2.4

*- In case of asymmetric recesses (e.g. bowrider, centercockpits, ...), please insert length and breadth of each area below; this allows a more exact calculation using simplified method 1) or 2)*

	max. length	max. breadth	Unit	% loss GMT (option 1)	% loss GMT (option 2)	Ref.
Maximum length and breadth of recess part A			m			6.5.2.2/3
Maximum length and breadth of recess part B			m			6.5.2.2/3
Maximum length and breadth of recess part C			m			6.5.2.2/3
Maximum length and breadth of recess part D			m			6.5.2.2/3
Maximum length and breadth of recess part E			m			6.5.2.2/3
Maximum length and breadth of recess part F			m			6.5.2.2/3
Maximum length and breadth of recess part G			m			6.5.2.2/3
Maximum length and breadth of recess part H			m			6.5.2.2/3
Maximum length and breadth of recess part I			m			6.5.2.2/3

to be continued on page 2

**ISO 12217-1:2017 CALCULATION WORKSHEET No. 8**

page 2

	Symbol	Unit	Value	Ref.
			Recess	
Average freeboard to recess periphery $= (F_A + 2F_S + F_F) / 4$	$F_R$	m	0	6.5.2.1
Category A permitted percentage loss in metacentric height $(GM_T) = 250 F_R / L_H$			n.a.	6.5.2.1
Category B permitted percentage loss in metacentric height $(GM_T) = 550 F_R / L_H$			0	6.5.2.1
Category C permitted percentage loss in metacentric height $(GM_T) = 1\,200 F_R / L_H$			n.a.	6.5.2.1

SIMPLIFIED METHOD: Use 1), 2) or 3) below.				Recess	
<b>1) Loss of <math>GM_T</math> used?</b>					6.5.2.1
Second moment of area of free-surface of recess	$SMA_{RECESS}$	$m^4$	0		6.5.2.2
Metacentric height of boat at $m_{LA}$	$GM_T$	m			6.5.2.2
Calculated percentage loss in metacentric height	$(GM_T) = \frac{102\,500 \times SMA_{RECESS}}{m_{LA} \times GM_T}$				6.5.2.2
<b>2) Second moment of areas used?</b>					6.5.2.1
Second moment of area of free-surface of recess	$SMA_{RECESS}$	$m^4$	0		6.5.2.3
Second moment of area of waterplane of boat at $m_{LA}$	$SMA_{WP}$	$m^4$	0		6.5.2.3
Calculated percentage loss in metacentric height	$(GM_T) = \left( \frac{245 \times SMA_{RECESS}}{SMA_{WP}} \right)$				6.5.2.3
<b>3) Recess dimensions used?</b>					6.5.2.1*
Maximum length of recess at the retention level (see 3.5.11)	$l$	m	0		6.5.2.4
Maximum breadth of recess at the retention level (see 3.5.11)	$b$	m	0		6.5.2.4
Calculated percentage loss in metacentric height	$(GM_T) = 270 \left( \frac{l \times b^3}{L_H \times B_H^3} \right)^{0.7}$				6.5.2.4

<b>Requirement:</b> from results above, applied design category possible?	<b>Fail</b>	6.5.2.1
---	-------------	---------

DIRECT CALCULATION METHOD used?					6.5.3
Percentage full of water = $60 - 240 F/L_H$					6.5.3a)
Wind heeling moment for intended design category	$M_W$	N·m	4044,46392		6.5.3b)
Crew heeling moment at $\phi_{GZmax}$		N·m			6.5.3c)
Maximum swamped righting moment up to least of $\phi_D$ , $\phi_V$ or $50^\circ$		N·m			6.5.3d)
Required margin of righting moment over heeling moment		N·m	5649,75		6.5.3d)
Actual margin of righting moment over heeling moment		N·m			6.5.3d)

<b>Applied design category possible?</b>	<b>n.a.</b>	
--	-------------	--

Design category C boats using option 6			
Recess entirely contained within LH/2 of the bow ?			6.5.4
Volume to retention level (see 3.5.9) larger than $(L_H B_H F_M) / 40$ ?			6.5.4
If both questions are answered with 'yes' check requirements below:			
Recess is quickdraining recess either overboard or in the bilge?			6.5.4
Design category possible		<b>n.a.</b>	6.5.4

**ISO 12217-1:2017 CALCULATION WORKSHEET No. 9 Habitable Multihulls & Motor Sailers**

Diplomski rad IKAS 105

**Habitable Multihulls** Is boat habitable multihull acc. to cl. 3.1.8 ?

**NB: Boats complying with the other requirements of this standard for design categories A, B or D are not considered to be susceptible to inversion**

**Boats of design category C:**

Item	Symbol	Unit	Value	Ref.
Beam of hull	$B_H$	m	3,20	3.3.3
Volume of displacement in minimum operation condition	$V_D$	m <sup>3</sup>	4,68	3.4.7
Cube root of volume of displacement in $m_{MO}$	$V_D^{1/3}$	m	1,67	
Height of centroid of $A_{LV}$ above $m_{MO}$ waterline	$h_C$	m		6.6.3
Actual value of $h_C / B_H$	$h_C / B_H$	/		
Boat considered to be susceptible to inversion if either (10) or (11)				6.6.3
(10) when $V_D^{1/3} > 2,6$ and $h_C / B_H > 0,572$			n.a.	6.6.3
(11) when $V_D^{1/3} \leq 2,6$ and $h_C / B_H > 0,22 V_D^{1/3}$				6.6.3
<b>Is boat susceptible to inversion in design category C?</b>			No	
If 'Yes', boat must comply with ISO 12217-2, cl. 7.12 and cl. 7.13 (relevant ISO 12217-2 worksheets to be used)				6.6.1
Boat complies with ISO 12217-2, cl. 7.12 buoyancy when inverted?		Yes / No		6.6.1a)
Boat complies with ISO 12217-2, cl. 7.13 escape after inversion?		Yes / No		6.6.1b)

**Motor Sailer** Is boat defined as "non-sailing" ?   
Is boat fitted with mast and sails?

**NB: Only applicable to non-sailing boats with sails of design cat A or B**

Item	Symbol	Unit	Value	Ref.
Sum of the windage area as defined in 3.3.7 plus the actual profile area, including overlaps, of the largest sail plan suitable for windward sailing in true winds of more than 10 kn to 12 kn (5,1 m/s to 6,2 m/s) and supplied or recommended by the builder as standard;	$A_{max}$	m <sup>2</sup>		6.7.2
Vertical distance between the geometric centres of $A_{max}$ and underwater profile area	$h$	m		6.7.2
Wind speed, 18 m/s for category A and 14 m/s for category B	$v_W$	m/s	14,00	6.7.2
Heeling moment due to wind ( $M_W = 0,53 A_{max} h v_W^2$ )	$M_W$	Nm	0	6.7.2
Maximum righting moment of the boat in $m_{LA}$ up to $\Phi_{DA}$	$RM_{max1}$	Nm	20.111	3.5.11
<b>Wind heeling moment <math>M_W</math> less than 50% of <math>RM_{max1}</math> ?</b>			Pass	6.7.2

**ISO 12217-1:2017 CALCULATION WORKSHEET No.10 FLOTATION TEST**

Diplomski rad IKAS 105

**Annexes E and F**
**assumed Crew Limit (CL) = 10**
*theoretical calculation method used, calculation attached?*
**Preparation**

Item	Unit	Response	Ref.
Mass equal to 25% of dry stores and equipment added?			F.2 a)
Inboard or outboard engine fitted?			
If inboard fitted, correct engine replacement mass fitted?			F.2 d)
Assumed outboard engine power?	Kw	460	F.2 c)
Mass fitted to represent outboard engine, controls, and battery.	kg	900	Tables F.1 and F.2
Portable fuel tanks removed and/or fixed tanks are filled?			F.2 f)
Cockpit drains open and drain plugs are fitted?			F.2 g)
Void compartments which are not air tanks are opened?			F.2 i)
Number of integral air tanks required to be open?			Table F.3
Type of test weights used: lead, 65/35 brass, steel, cast iron, aluminum			F.3.2
Material factor <i>d</i>		Failure	Table F.4

**Swamped stability test:**

Item	Unit	Response	Ref.
Dry mass of test weights = $6dCL$ but $\geq 15d$	kg	#VALUE!	Table F.6
Test weight hung from gunwale each of four positions in turn?			F.3.1
5 min after swamping, boat heels less than $45^{\circ}$			F.3.4 + F.3.5

**Swamped buoyancy test:**

Item	Unit	Response	Ref.
<b>Load test:</b>			F.4
Design Category assessed		B	
Dry mass of test weights used	kg	#VALUE!	Table F.5
5 min after swamping, boat floats approximately level with more than 2/3 of periphery above water?			F.4.3

**Swamped buoyancy test (for design cat B only)**

Item	Unit	Response	Ref.
Total buoyant volume according to Iso 6185-4:2011, clause 7.6.1 and 7.6.2	m <sup>3</sup>		F.4.4; ISO 6184-4
$1,33 m_{LDC} / 1000$	t	8,186815	3.4.5
Total buoyant volume > $1,33 m_{LDC} / 1000$ ?		n.a.	F.4.4

**Flotation material and elements:**

Item	Response	Ref.
All flotation elements comply with all requirements?		Table G.1

**Design Category given: NB: boat must obtain PASS in all above tables**
**Fail**

**ISO 12217-1:2017 CALCULATION WORKSHEET No. 11 DETECTION + REMOVAL OF WATER**

Diplomski rad IKAS 105

Item	response	Ref.
The internal arrangement facilitates the drainage of water to bilge suction point(s), to a location from which it can be bailed rapidly, or directly overboard?	Yes	6.9.1
Is boat provided with a means of removing water from the bilges in accordance with 15083?	Yes	6.9.2
Table 2 option used for assessment:	1	6.9.3; 5.4 table 2
Can water in boat be detected from helm position?		6.9.3
Methods used: direct visual inspection		6.9.3
transparent inspection panels		6.9.3
bilge alarms		6.9.3
indication of the operation of automatic bilge pumps		6.9.3
other means (specify):		6.9.3

ISO 12217-1:2017 en220801

CALCULATION WORKSHEET No.12

SUMMARY

Design Description: <b>Diplomski rad IKAS 105</b>	
Design Category intended: <b>B</b>	Crew Limit: <b>10</b> Date: <b>2023-09-14</b>

Sheet	Item	Symbol	Unit	Value		
	<b>Length of hull:</b> (as in ISO 8666)	$L_H$	m	<b>10,50</b>		
	<b>Length of waterline in loaded arrival condition</b>	$L_{WL}$	m	<b>9,26</b>		
	<b>Beam of hull:</b> (as in ISO 8666)	$B_H$	m	<b>3,20</b>		
	<b>Masses:</b>					
1	Empty craft mass	$m_{EC}$	kg	<b>1831</b>		
	Maximum load	$m_L$	kg	<b>1561</b>		
	Maximum load for the builder's plate acc. to ISO 14945:2021	$m_{MBP}$	kg	<b>1000</b>		
	Number of portable tanks included in builder's plate weight			<b>0</b>		
	Light craft condition mass	$m_{LC}$	kg	<b>4595</b>		
	Maximum Loaded condition mass = $m_{LC} + m_{ML}$	$m_{LDC}$	kg	<b>6156</b>		
	Loaded arrival condition mass	$m_{LA}$	kg	<b>5650</b>		
	Minimum operating condition mass	$m_{MO}$	kg	<b>4795</b>		
1	<b>Is boat sail or non-sail?</b>	SAIL/NON-SAIL		<b>NON-SAIL</b>		
2	<b>Option selected:</b>				<b>1</b>	
3	<b>Downflooding openings:</b>	Are all requirements met?			<b>Pass</b>	
		Watertightness test for closing appliances done successful?			<b>Pass</b>	
		Exemptions ok or openings considered as possible downflooding openings?			<b>n.a.</b>	
3	<b>Downflooding angle:</b> (Categories A and B only)	degrees	Required	$m_{MO}$	$m_{LA}$	<b>Pass/Fail</b>
		degrees	> 25	<b>48</b>	<b>50</b>	<b>Pass</b>
3 & 4	<b>Downflooding height:</b> Worksheet employed for basic height	exempted acc. to 6.1.2.1?		<b>0</b>		
	basic requirement	m	0,62	<b>1,56</b>	<b>Pass</b>	
	reduced height for small openings (only using figures)	m	0,46	<b>1,56</b>	<b>Pass</b>	
	reduced height at outboard (options 3, 4, 6 only)	m	n.a.	<b>1,56</b>	<b>n.a.</b>	
	increased height at bow (options 3, 4, 6 only)	m	n.a.	<b>1,56</b>	<b>n.a.</b>	
5	<b>Off-set load test:</b>	<b>Unit</b>	<b>Required</b>	<b>Actual</b>	<b>Pass/Fail</b>	
	Testing for least stability: maximum heel angle	degrees	< 16,23	<b>2,00</b>	<b>Pass</b>	
	Testing for least freeboard: heeled freeboard margin	m	n.a.	<b>0,15</b>	<b>n.a.</b>	
	Maximum crew limit for stability			<b>10</b>		
	Maximum crew limit for freeboard			<b>10</b>		
6	<b>Resistance to waves and wind:</b> (options 1, 3) at $m_{LA}$ and $m_{MO}$					
	<b>Rolling in beam waves and wind:</b> ratio $A_2/A_1$	-	$\geq 1.0$	<b>1,30</b>	<b>1,93</b>	<b>Pass</b>
	Resistance to waves: value of $\sigma_{GZMax}$	degrees	---	<b>65,00</b>	<b>65,00</b>	
	value of $RM_{30}$ or $RM_{MAX}$	kNm	7	<b>11,52</b>	<b>9,69</b>	<b>Pass</b>
	value of $GZ_{30}$ or $GZ_{MAX}$	m	0,2	<b>0,21</b>	<b>0,21</b>	<b>Pass</b>

7	<b>Heel due to wind:</b> (options 2,4,5,6) at $m_{LA}$ and at $m_{MO}$					n.a.
	at $m_{MLA}$ : heel angle due to wind	degrees	<		4,68	n.a.
	if required at $m_{MO}$ : heel angle due to wind	degrees	<	9,37		n.a.
8	<b>Recess size:</b> (options 1 and 2 except category D)					
	Simplified method: max reduction in $GM_T$	%	≤	0		n.a.
	Direct calculation: margin righting moment over heeling moment	N m	≥	5649,75		n.a.
	For category C boats using option 6; drainage requirements for recesses entirely contained within LH/2 of the bow are fulfilled?					n.a.
9	<b>Habitable Multihulls:</b> Is Category C boat vulnerable to inversion?			Yes / No		
	Complies with Part 2 clause 7.12 for inverted buoyancy?			Pass / Fail		
	Complies with Part 2 clause 7.13 for means of escape?			Pass / Fail		
9	<b>Motor Sailers</b> Complies with requirement for excess of $RM_{MAX}$ over $M_W$ ?			Pass / Fail		
10	<b>Flotation test:</b> (options 3 and 4 only) All preparations completed?			Yes / No		n.a.
	<b>Swamped stability:</b> 5 min after swamping, does boat heel less than 45°?			Pass / Fail		n.a.
	<b>Load test:</b> 5 min after swamping, does boat float level with 2/3 periphery showing?			Pass / Fail		n.a.
	<b>Swamped buoyancy,</b> for boats using option 3: Total buoyant volume > 1,33 $m_{LDC} / 1000$ ?			Pass / Fail		n.a.
	<b>Flotation elements:</b> do all elements comply with all the requirements?			Pass / Fail		n.a.
11	<b>Detection &amp; removal of water</b> are all requirements satisfied?			Yes / No		Yes
<b>NB:</b> Boat must pass all requirements applicable to selected option to be given intended Design Category.						
<b>Design Category given:</b>	<b>B</b>	Assessed by:	<b>Ivan Kašikić</b>			

Documentation of downflooding opening / closing appliance (photo/drawing) attached?

If applicable, cockpit calculation according to ISO 11812 attached ?

If applicable, curve of righting moments in  $m_{MO}$  and  $m_{LA}$  attached ?

Appropriate add. information attached (e.g. photos, drawings,...) ?

If applicable, ISO 12216 calculation attached?

Signature: \_\_\_\_\_



## ISO 12217-1:2017 NON-SAILING BOATS OF LENGTH GREATER THAN OR EQUAL TO 6m

Manufacturer:	Diplomski rad
Signatory, Name:	Ivan Kašikić
Signatory, Title:	Vodomlazni pogonski sustav
Phone:	
Email:	
WWW:	
CIN Model Year:	
Model Name:	IKAS 105

*This calculation sheet is provided by IMCI "as is" and any express or implied warranties, including, but not limited to, the implied warranties of fitness for a particular purpose are disclaimed.*

blue cells are derived values

yellow cells require data input

Please make sure to set your signature on the summary! (worksheet 12)  
either digitally or print summary, sign and attach scan

- most worksheets have additional comments / remarks / other calculations beside the printout area; please take into account.

- For boats in category A and B either fill in worksheet 6c and 6d or attach curve of righting moments for both loading conditions to the documentation.

- For boats with quick-draining cockpit the cockpit calculation according to ISO 11812 shall be enclosed to the documentation.

- Please attach other detailed information as appropriate, e.g. photos, sketches etc. for sill height, openings, companion way doors, location of flooding points, practical tests etc.

- When entering data, please use the correct separator for your Excel version, many application problems are the result of incorrect separators ( , or . )

- Please send questions, found errors, typos, mistakes, ect. directly to ralf.dewender@imci.org or to the headoffice with info@imci.org; every comment helps us to provides you with a better version

- Please be aware that there is NO technical difference between the requirements of ISO 12217-1:2015 and EN ISO 12217-1:2017; change of the name is just because of the harmonisation process; for ISO 12217-1:2020 the main change is the exclusion of optional equipment and margin for future additions from the maximum load and the result of the "maximum recommended load for builder's plate" (with ISO 14945:2021 and ISO 14946:2021 renamed to "maximum load for the builder's plate,  $m_{MBP}$ ") which exludes OB engine weights and the optional equipment.

**ISO 12217-1:2017 NON-SAILING BOATS OF LENGTH GREATER THAN OR EQUAL TO 6m  
CALCULATION WORKSHEET No. 1**

ISO 12217-1:2017 en220801

Diplomski rad IKAS 105

Design Category intended:	C	Monohull / Multihull:	Monohull	Propul.Type:	OB
Item	Symbol	Unit	Value	Ref.	
Length of hull as in ISO 8666	$L_H$	m	10,50		3.3.1
Length of waterline in loaded arrival condition	$L_{WL}$	m	9,26		3.3.2
<u>Empty Craft condition mass</u>	$m_{EC}$	kg	1831,0		3.4.1
standard equipment (incl. OB engine(s) and ess. safety equipment)		kg	2764,0		3.5.12
water ballast in tanks which are notified in the owner's manual to be filled when the boat is afloat		kg	0,0		3.4.2
Light craft condition mass	$m_{LC}$	kg	4595,0		3.4.2
<b>Mass of:</b>					
Desired crew limit	CL	----	10		3.5.3
Mass of:					
desired crew limit at 75 kg each		kg	750,0		
provisions + personal effects		kg	250,0		3.4.4
drinking water		kg	28,5		3.4.4
fuel		kg	304,0		3.4.4
lubricating and hydraulic oils		kg	19,0		3.4.4
black water		kg	47,5		3.4.4
grey water		kg	133,0		3.4.4
water ballast		kg	0,0		3.4.4
other fluids carried aboard		kg	28,5		3.4.4
stores, spare gear and cargo (if any)		kg	0,0		3.4.4
inflatable life raft(s) in excess of essential safety equipment		kg	0,0		3.4.4
other small boats carried aboard		kg	0,0		3.4.4
Maximum load = sum of above masses <b>using ISO ISO 12217-1:2020</b>	$m_L$	kg	1560,5		3.4.4
optional equipment and fittings not included in basic outfit		kg	0,0		3.4.4 / 3.4.5
Maximum load = sum of above masses <b>using ISO 12217-1:2017</b>	$m_L$	kg	1560,5		3.4.4
<u>Maximum Load condition mass</u>	$m_{LDC}$	kg	6155,5		3.4.5
Mass to be removed for loaded arrival condition		kg	505,8		3.4.6
<u>Loaded Arrival condition mass</u>	$m_{LA}$	kg	5649,8		3.4.6
Mass of:					
minimum number of crew weight according to 3.4.3		kg	150,0		3.4.3a)
non-consumable stores and equipment normally aboard		kg	50,0		3.4.3b)
inflatable life raft		kg			3.4.3
Load to be included in Minimum Operating Condition	$m'_L$	kg	200,0		3.4.3
<u>Light craft condition mass</u>	$m_{LC}$	kg	4595,0		3.4.2
Mass in the Minimum Operating Condition	$m_{MO}$	kg	4795,0		3.4.3
<u>Maximum load for the builder's plate using EN ISO 14946:2021 and EN ISO 14945:2021 (if manually reduced on Worksheet 1b the reduced value is shown)</u>	$m_{MBP}$	kg	1000,0		
<b>Is boat sail or non-sail?</b> Nominal sail area	$A_S^*$	m <sup>2</sup>	0,0		3.3.8
Sail area / displacement ratio = $A_S / (m_{LDC})^{2/3}$		----	0,0000		3.1.2
CLASSIFIED AS [non-sail if $A_S / (m_{LDC})^{2/3} < 0.07$ ]	SAIL/NON-SAIL ?		<b>NON-SAIL</b>		3.1.2
NB If NON_SAIL, continue using these worksheets, if SAIL, use ISO 12217-2					

## ISO 12217-1:2017 / ISO 14945:2021 CALCULATION WORKSHEET No.1b Builder's plate

Diplomski rad IKAS 105

Since 2021-12-09 EN ISO 14945:2021 and EN ISO 14946:2021 are harmonised!

The formerly 'Maximum recommended load for builder's plate' became '**Maximum load for the builder's plate**',  $m_{MBP}$ .

$m_{MBP}$  does not include the optional equipment anymore; also the weight of outboard engines is excluded from  $m_{MBP}$  and can be shown in a separated line on the plate.

Below you find two examples for the builder's plates with the maximum value for  $m_{MBP}$  calculated from the stability calculation on worksheet 1; one for craft powered by outboard engines, one for craft powered by inboard or sterndrive engines.

For portable tanks, please change the default 'yes' on the right side in 'no, portable tank'; the weight of the tank will be included in  $m_{MBP}$ .

Please be aware that ISO 14946:2021 allows in clause 6 that the maximum recommended load can be downrated or limited by the manufacturer at any time. Therefore you find an extra cell to enter a manual reduced value for the maximum load for the builder's plate.

Default outboard engine mass is calculated with the help of table F.1 from EN ISO 12217-1:2017; nevertheless the manufacturer can insert the actual engine mass the boat model is calculated with.

This is strongly recommended for engines with more than 164,2 kW which are outside the table range (means all 300, 350, 400, 450 and more HP outboard engines) !

Please be also aware that the design of these plates is just a proposal from EN ISO 14945, the manufacturer is free to change the design as long all requirements of the standard are fulfilled.

Item	Value	Unit	Ref.
Manually reduced value for the 'Maximum load for the builder's plate' $m_{MBP}$	1000	kg	EN ISO 14945, cl. 6, note 2
Maximum engine power of a single engine	230	kW	
Maximum number of engines	2		
Actual value of the max. outboard engine mass, (sum of all engines) as defined by the manufacturer and used for stability calculation (default value is table F.1 from ISO 12217-1:2017 value)	900	kg	EN ISO 12217-1:2017 table F.1

Please see builder's plate example with values calculated from worksheet 1 entries on next page:

Builder's plate information for craft powered by outboard engines -- Example

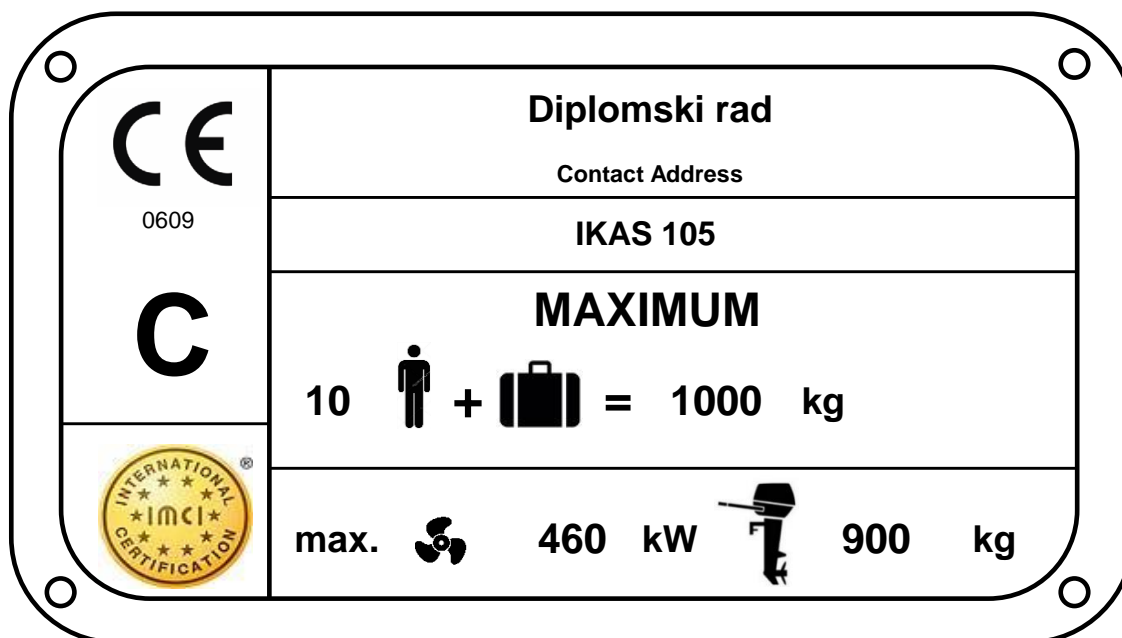

Builder's plate information for craft powered by inboard or sterndrive engines

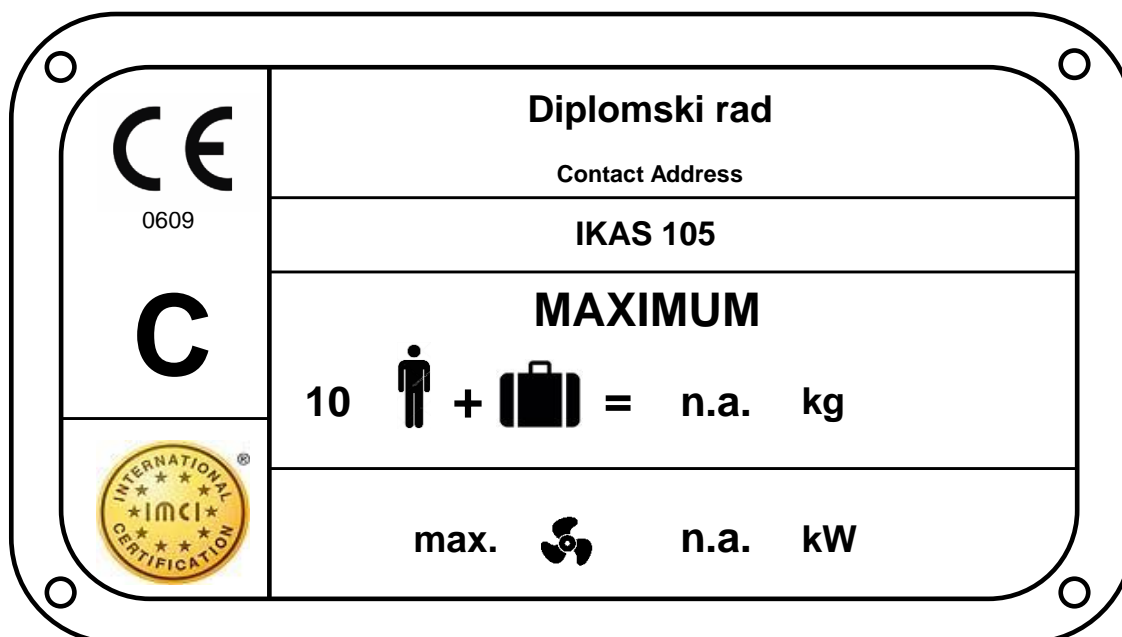

## ISO 12217-1:2017 CALCULATION WORKSHEET No.2 TESTS TO BE APPLIED

Diplomski rad IKAS 105

Question	Answer	Ref.
Is boat fully enclosed? (see definition in ref.) YES/NO?	Yes	3.1.6
Is boat partially protected? (see definition in ref.) YES/NO?	No	3.1.7

Item	Symbol	Unit	Value	Ref.
Windage area in minimum operating condition	$A_{LV}$	$m^2$	14,64	3.3.7
Length of Hull	$L_H$	m	10,50	3.3.2
Beam of hull	$B_H$	m	3,20	3.3.3
Freeboard at midships	$F_M$	m	1,48	3.3.5
Ratio $A_{LV}/(L_H B_H)$		---	0,44	

Choose any ONE of the following options and use all the worksheets indicated for that option.

Option	1	2	3	4	5	6
Categories possible	A and B	C and D	B	C and D	C and D	C and D
Decking or covering	fully enclosed	fully enclosed	any amount	any amount	partially protected	any amount
Downflooding openings	3	3	3	3	3	3
downflooding angle	3		3			
Downflooding height test	All boats	3	3	$3^a$	3	3
	Annex A method	4	4	$4^a$	4	4
Offset load test	5	5	5	5	5	5
Resistance to waves + wind	6		6			
Heel due to wind action		$7^b$		$7^b$	$7^b$	$7^b$
Recess size	8	$8^c$				$8^c$
Habitable multihulls	9	9	9	9	9	9
Motor sailers	9	9	9	9	9	9
Flotation test			10	10		
Flotation material			10	10		
Detection and removal of water	11	11	11	11	11	11
SUMMARY	12	12	12	12	12	12

a. The downflooding height test is not required to be conducted on the following Category C and D boats:

I. those which, when tested in accordance with normative annex F.4, have been shown to support, in addition to the mass required by F.2 and Table F.5, an additional equivalent dry mass (kg) of  $(75 \cdot CL + 10\%$  of dry weight of stores and equipment included in the maximum total load), or  
 II. those boats that do not take on water when heeled to  $90^\circ$  from the upright in the light craft condition.

b. The application of Worksheet 7 is only required for boats where  $A_{LV}/(L_H B_H) > 0,5$ .

c. Only required for boats of design category C; for option 6 clause 6.5.4 only

**Option selected**

**2**

**ISO 12217-1:2017 CALCULATION WORKSHEET No. 3 DOWNFLOODING**

Diplomski rad IKAS 105

**Downflooding Openings:**

Question	Answer	Ref.
Have all appropriate downflooding openings been identified?	Yes	3.2.1
Have potential downflooding openings within the boat been identified?	Yes	6.1.1.4
Do all closing appliances satisfy ISO 12216?	Yes	6.1.1.1
Hatches or opening type appliances are not fitted below minimum height above waterline? *	Yes	6.1.1.2
Seacocks comply with requirements?	Yes	6.1.1.3
Are all openings on design category A or B boats fitted with closing appliances? **	Yes	6.1.1.5
<b>Categories possible:</b> A or B if all are YES, C or D if first five are YES	<b>A</b>	6.1.1

\* Except for emergency escape hatches on design category C boats, where 0,1 m is allowable \*\* Except openings for ventilation and engine combustion

**Exemptions Downflooding Openings:**

Question	Answer	Ref.
Drains from quick-draining recesses or watertight recesses acc. to cl. 6.1.1.6 b) are either:		
1) freeing ports with non-return flaps which are watertight from the exterior (degree 3) <b>or</b>		6.1.1.6 b)
2) have a drainage area smaller than three times the minimum area required of ISO 11812		6.1.1.6 b)
		6.1.1.6 b)
Opening appliances (e.g. side doors) in the topsides which comply with ISO 12216 are		
1) referenced in the owner's manual as watertight closure to be kept shut when under way, <b>and</b>		6.1.1.6 d)
2) marked inboard with "KEEP SHUT WHEN ..." in upper case letters not less than 4,8 mm high, <b>and</b>		6.1.1.6 d)
3) the height above waterline of the lowest part is > 50% of required downflooding height		6.1.1.6 d)
		6.1.1.6 d)
All other exemptions of cl. 6.1.1.6 checked and requirements fulfilled?		6.1.1.6
		6.1.1.6

**Downflooding angle (required for cat A & B only\*):**

Item	Symbol	Unit	Value	Ref.
required Category A = larger of $(\phi_O + 25)^\circ$ or $30^\circ$	$\phi_{D(R)}$	degrees	n.a.	6.1.3; Table 3
( $\phi_O$ = angle from offset load test)				
required Category B = larger of $(\phi_O + 15)^\circ$ or $25^\circ$	$\phi_{D(R)}$	degrees	n.a.	6.1.3; Table 3
Area of openings permitted to be submerged = $1.2 L_H B_H F_M$		cm <sup>2</sup>	<b>59,67</b>	6.1.3
<u>Actual downflooding angle:</u> at mass = $m_{MO}$	$\phi_{DA}$	degrees	<b>48</b>	6.1.3
at mass = $m_{LA}$	$\phi_{DA}$	degrees	<b>50</b>	6.1.3
Method used to determine $\phi_D$ :				Annex C
Design category possible on Downflooding Angle:			<b>n.a.</b>	6.1.3

**Downflooding Height: (all exempt exempt boats)**

Requirement		Basic requirement	Reduced value for small openings	Reduced value at outboard	Increased value at bow	
Is boat exempted from downflooding height requirements according to 6.1.2.1?		Yes / No				
Applicable to		all options	all options (using figures)	options 3, 4 or 6	options 3, 4, 6	
ref.		6.1.2.2 a)	6.1.2.2 d)	6.1.2.2 c)	6.1.2.2 b)	
obtained from Figs. 3 + 4 or annex A?		<b>fig 3 &amp; 4</b>	= basic x 0.75	= basic x 0.80	= basic x 1.15	
Maximum area of small openings ( $50L_H^2$ ) (mm <sup>2</sup> ) =			5513	///////	///////	
Required downflooding height $h_{D(R)}$	Fig. 3/ann. A	Category A	<b>0,62</b>	<b>0,46</b>	<b>0,49</b>	<b>0,71</b>
	Fig. 3/ann. A	Category B	<b>0,62</b>	<b>0,46</b>	<b>0,49</b>	<b>0,71</b>
	Fig. 3/ann. A	Category C	<b>0,62</b>	<b>0,46</b>	<b>0,49</b>	<b>0,71</b>
	Fig. 4/ann. A	Category D	<b>0,40</b>	<b>0,30</b>	<b>0,32</b>	<b>0,46</b>
<u>Actual Downflooding Height</u> $h_D$			<b>1,56</b>	<b>1,56</b>	<b>1,56</b>	<b>1,56</b>
Design Category possible		<b>C</b>	<b>C</b>			
Design Category possible on Downflooding Height = lowest of above					<b>C</b>	

## ISO 12217-1:2017 CALCULATION WORKSHEET No.3a DOWNFLOODING OPENINGS / CLOSING APPLIANCES

Diplomski rad IKAS 105

### General overview downflooding openings and closing appliances

**NOTE:** All drawings are not blocked by a password, so please replace with own drawings if at hand.

**NOTE:** See X, Y, Z coordinates for worksheet 3b as illustrated below

Top View

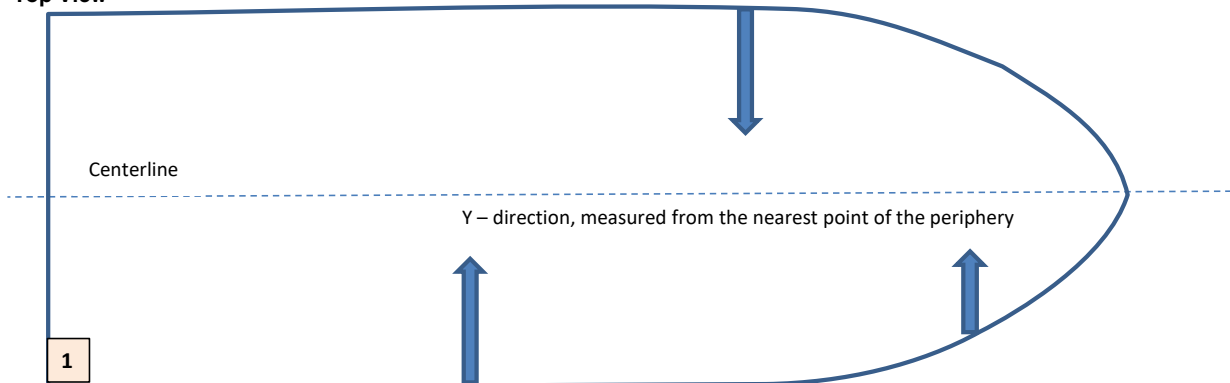

Side View Starboard

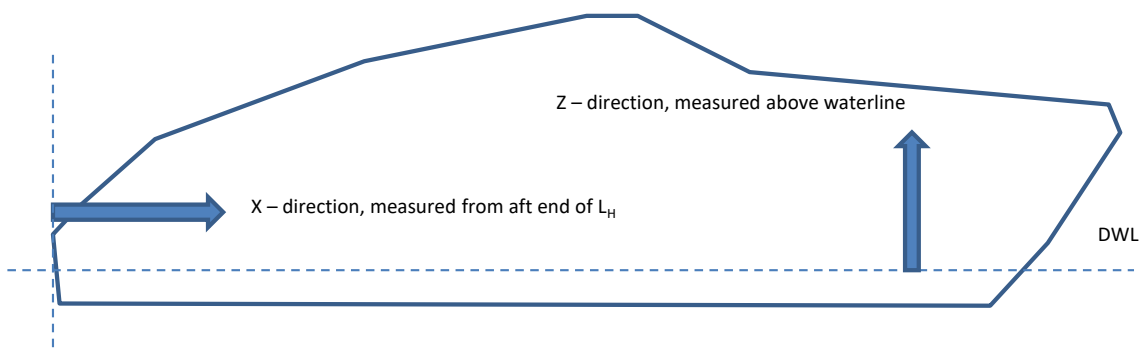

Side View Port

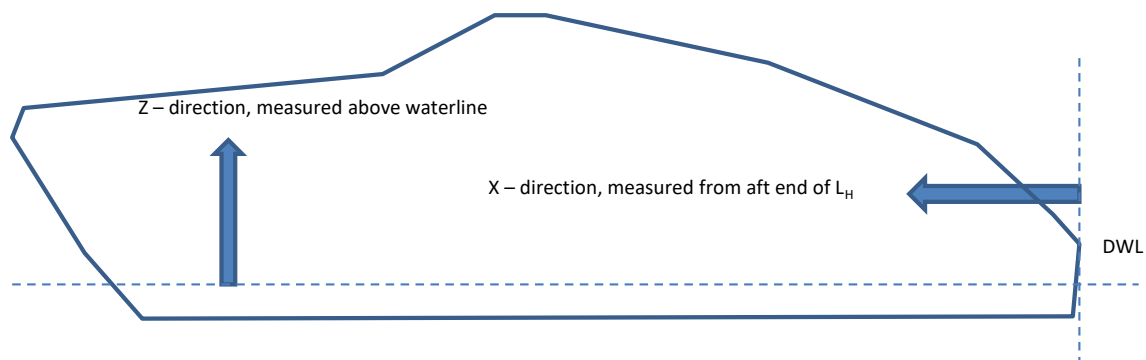

Please insert a short description and measurements of downflooding openings and closing appliances under the corresponding number on worksheet 3b

## ISO 12217-1:2017 CALCULATION WORKSHEET No.3b DOWNFLOODING OPENINGS

Diplomski rad IKAS 105

### General overview downflooding openings and closing appliances

**NOTE:** Please submit for every pre-fabricated closing appliance a declaration of conformity (DoC) of the product.  
Please submit for every non pre-fabricated closing appliance a calculation acc. to ISO 12216 (see IMCI template).  
For both a watertightness test must be done!

Description of the downflooding opening / closing appliance	Nr.	X <sup>(a)</sup> [m]	Y [m]	Z (=h <sub>D</sub> ) [m]	watertightness test done	opening type <sup>(b)</sup>
Razma	1	0,00	0,00	1,56	n.a.	downflooding opening
	2					
	3					
	4					
	5					
	6					
	7					
	8					
	9					
	10					
	11					
	12					
	13					
	14					
	15					
	16					
	17					
	18					
	19					
	20					
	21					
	22					

**(a)** Please be aware that X is measured from the aft end of L<sub>H</sub>.

In Annex A calculations x<sub>D</sub> is measured from the bow or stern, whichever is nearest

**(b)** opening types are: normal downflooding openings without any opening appliances; pre-fabricated opening appliances; non-pre-fabricated opening appliances and other devices



## ISO 12217-1:2017 CALCULATION WORKSHEET No.4 DOWNFLOODING HEIGHT

Diplomski rad IKAS 105

### Calculation using annex A

Item	Symbol	Unit	Opening 1	Opening 2	Opening 3	Opening 4
<b>Position of openings</b>						
Least longitudinal distance from bow/stern	$x_D$	m				
Least transvers distance from gunwale	$y_D$	m				
$F_1 = \text{greater of } (1 - x_D/L_H) \text{ or } (1 - y_D/B_H)$	$F_1$	----	1,00	1,00	1,00	1,00
<b>Size of openings:</b>						
Combined area of openings to top of any down-flooding opening	$a$	mm <sup>2</sup>				
Longitudinal distance of opening from tip of bow	$x'_D$	m				
Limiting value of $a = (30L_H)^2$		mm <sup>2</sup>	99225	99225	99225	99225
$\text{If } a \geq (30L_H)^2, F_2 = 1,0$ $\text{If } a < (30L_H)^2, F_2 = 1 + \frac{x'_D}{L_H} \left( \frac{\sqrt{a}}{75 L_H} - 0,4 \right)$	$F_2$	----	1,00	1,00	1,00	1,00
<b>Size of recesses:</b>						
Volume of recesses which are not self-draining in accordance with ISO 11812	$V_R$	m <sup>3</sup>				
Is opening not a recess? Is recess quickdraining? Is recess not quickdraining?						
$k = V_R/(L_H B_H F_M)$	$k$	----	0	0	0	0
If opening is not a recess, $F_3 = 1$						
If recess is quickdraining, $F_3 = 0.7$	$F_3$	----	1,20	1,20	1,20	1,20
If recess is not quick draining, $F_3 = (0.7 + k^{0.5})$						
<b>Displacement:</b>						
Loaded displacement volume (see 3.4.5)	$V_D$	m <sup>3</sup>	6,01			
$B = B_H$ for monohulls, $B_{WL}$ for multihulls	$B$	m	3,2			
$F_4 = [(10 V_D)/(L_H B^2)]^{1/3}$	$F_4$	----	0,82			
<b>Flotation:</b>						
For boats using option 3 or 4, $F_5 = 0.8$						
For all other boats, $F_5 = 1.0$	$F_5$	----	1			
<b>Required calculation height: = <math>F_1 F_2 F_3 F_4 F_5 L_H / 15</math></b>	$h_{D(R)}$	m	0,69	0,69	0,69	0,69
Required downflooding height with limits applied (see annex A, Table A.1)	Category A	$h_{D(R)}$				
	Category B	$h_{D(R)}$				
	Category C	$h_{D(R)}$	0,3	0,3	0,3	0,3
	Category D	$h_{D(R)}$				
<b>Measured Downflooding Height:</b>	$h_D$	m				
<b>Design Category possible:</b>						
<b>Lowest of above =</b>						<b>Fail</b>

ISO 12217-1:2017 CALCULATION WORKSHEET - No. 5a

OFFSET LOAD TEST

Diplomski rad IKAS 105

Mass of people used for test

Name	Ident.	Mass (kg)
Person 1	A	85
Person 2	B	85
Person 3	C	85
Person 4	D	85
Person 5	E	85
Person 6	F	85
Person 7	G	85
Person 8	H	85
Person 9	I	85
Person 10	J	85

downflooding opening obvious to the crew?  Yes

Crew Area

Areas included and access limitations (if any):

Area	P/S	Incl?	Persons limit
Main Cockpit			
Aft Cockpit			
Fwd Cockpit			
Salon			
Cabins			
Side Decks			
Fore Deck			

Offset Load Test

Name	Ident.	Mass (kg)
Person 11	K	
Person 12	L	
Person 13	N	
Person 14	M	
Person 15	O	
Person 16	P	
Person 17	Q	
Person 18	R	
Person 19	S	
Person 20	T	

average mass per person:   
 number of persons permitted (through offset load test)

Area	P/S	Incl?	Persons limit
Cuddy Top			
Coachroof Top			
Wheelhouse Top			
Fly Bridge			
Swim Platform			

**Sketch:** Indicate possible seating locations along the length of the side to be tested using numbers, so that these may later be used to record the positions that people actually occupy. Locations should not be closer than 0.5 m between centers, and not less than 0.2 m from outboard edge unless on sidedecks less than 0.4 m wide.

1) Note whether it is asymmetric by adding P (port) or S (starboard) to denote the larger side.

**ISO 12217-1:2017 CALCULATION WORKSHEET - No. 5b**
**OFFSET-LOAD TEST**

Diplomski rad IKAS 105

**Stability Test - Full Procedure**

Boat being tested for:		x	stability	x	downflooding			please mark	
$L_H$ (m)	Min. permitted freeboard margin (m) (see Table 5)		Max. permitted heel angle (°) $= 11,5 + \frac{(24 - LH)^3}{520}$		Intended crew limit (CL)	Intended design category	Mass Test weights per person (kg) (Cat D only)	Max. Mass of test weights (kg) (= 98 x CL)	
10,50	0,147		16,23		10	C		980	
Does boat have a list?		No		If "YES" to which side?					
Is crew area asymmetric?		Yes		If "YES" to which side?					
Is downflooding asymmetric?		No		If "YES" to which side?					
Boat tested:		to Port							

**Test Data:**

Mass ident.	Location		Mass (kg)	Total mass (kg)	Lever (m)	Moment (kg-m)	Heel angle (°) P/S	min. freeb'd (m)	
	area	fore & aft						fwd	aft
1			85	85	0,32	26,78			
2			85	170	0,13	11,05			
3			85	255	0,85	72,25			
4			85	340	0,82	69,70			
5			85	425	1,12	95,20			
6			85	510	0,82	69,70			
7			85	595	0,75	63,75			
8			85	680	0,75	63,75			
9			85	765	0,69	58,65			
10			85	850	0,69	58,65	2,00	0,15	0,15
11				850		0,00			
12				850		0,00			
13				850		0,00			
14				850		0,00			
15				850		0,00			
16				850		0,00			
17				850		0,00			
18				850		0,00			
19				850		0,00			
20				850		0,00			

total:	$\Sigma$	max. angle	min freeboard	
	589,48	2,00	0,15	0,15

Max. mass of people allowed per above:	850	hence CL =	10	at	85	kg / person
--	-----	------------	----	----	----	-------------

Design category given: C

Safety Signs Required:	Fig B1:	No	Fig B2:	No	Fig B3:	No
------------------------	---------	----	---------	----	---------	----

## ISO 12217-1:2017 CALCULATION WORKSHEET No. 5c Simplified procedure for OFFSET LOAD TEST

Diplomski rad IKAS 105

This method may only be applied by calculation; requirements must be fulfilled for both conditions LC1 and LC2

### Preparation (curves of moments in Nm)

Question	Answer	ref.
Mass and the centre-of-gravity of the boat calculated for conditions LC1 and LC2?		B.3.2.2
Curves of righting moments calculated according to annex E?		B.3.2.3
Crew heeling moment curve calculated with $961 CL (B_C/2 - 0,2) \cos \phi$ or where the crew area includes side decks less than 0,4m wide with $480 CL BC \cos \phi$ ?		B.3.2.4

### Test data:

item	symbol	unit	LC1	LC2	ref.
Maximum transverse distance between the outboard extremities of any part of the crew area	$B_C$	m			B.3.2.4 & B.3.1.7
Heel angle at the point of intersection between crew heeling moment curve and the curve of righting moment	$\phi_O$	degrees	0,00	0,00	B.3.2.5
Maximum permitted heel angle	$\phi_{O(R)}$	degrees	16,23		B.3.2.5
Value of downflooding angle	$\phi_{DA}$	degrees			B.3.2.5
Value of minimum freeboard margin at $\phi_O$	$h_F$	m			
Minimum required freeboard margin	$h_{F(R)}$	m	0,15		6.2.2 table 4
Max. righting moment up to $\phi_{DA}$		Nm	#VALUE!	#VALUE!	
Crew heeling moment at $\phi_O$		Nm	FALSE	FALSE	

### Requirements:

Question	Answer	ref.
Is $\phi_O < \phi_{O(R)}$	Fail	B.3.2.5
Is $h_F > h_{F(R)}$	Fail	B.3.2.5
Is the max. righting moment up to $\phi_{DA} >$ crew heeling moment at $\phi_O$ ?	#VALUE! #VALUE!	B.3.2.5
Offset load test passed, if all questions above are answered with 'yes' (or n.a.)	Pass/Fail #VALUE!	B.3.2.5

**ISO 12217-1:2017 CALCULATION WORKSHEET No. 5d curve of righting moment LC1**

Diplomski rad IKAS 105

insert curve of righting moment in 5° steps in one of following units:

**OFFSET LOAD TEST**

<input type="text" value="Nm"/>	<input type="text" value="kg m"/>	<input type="text" value="m"/>	<input type="text" value="mLC1"/>	<input type="text" value="5975,25"/>
chosen unit				
crew heeling moment curve (either normal or if side decks smaller 0,4m)				

heel angle [°]	insert righting arm / moment [Nm, kg m, m]	righting moment [Nm]	righting moment [kg m]	righting arm Gz [m]	crew heeling moment curve [N m]
0		#VALUE!	#VALUE!	error	FALSE
5		#VALUE!	#VALUE!	error	FALSE
10		#VALUE!	#VALUE!	error	FALSE
15		#VALUE!	#VALUE!	error	FALSE
20		#VALUE!	#VALUE!	error	FALSE
25		#VALUE!	#VALUE!	error	FALSE
30		#VALUE!	#VALUE!	error	FALSE
35		#VALUE!	#VALUE!	error	FALSE
40		#VALUE!	#VALUE!	error	FALSE
45		#VALUE!	#VALUE!	error	FALSE
50		#VALUE!	#VALUE!	error	FALSE

point of intersection of righting moment curve and crew heeling moment curve

$\Phi_c$
<input type="text"/>

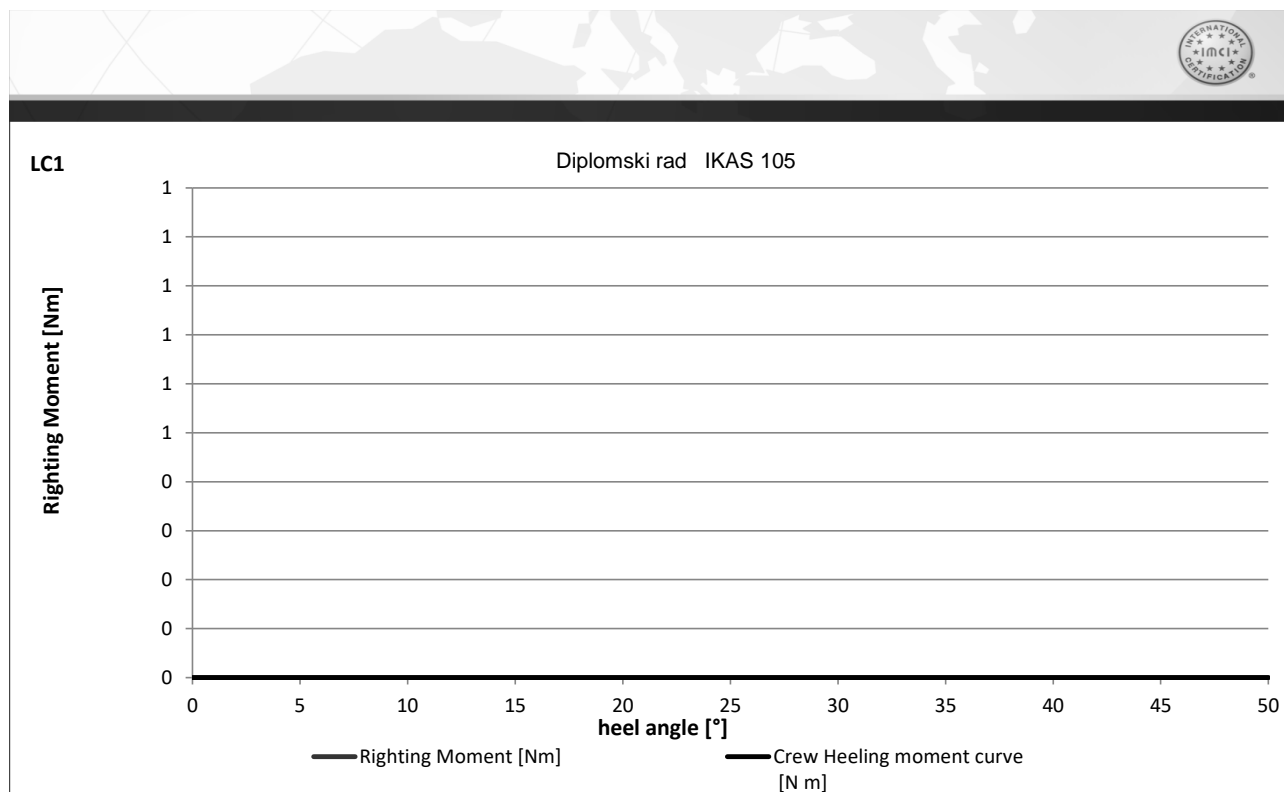



ISO 12217-1:2017 CALCULATION WORKSHEET No. 5e curve of righting moment LC2

Diplomski rad IKAS 105

insert curve of righting moment in 5° steps in one of following units:

OFFSET LOAD TEST

*N m*      *kg m*      *m*

*mLC2*     

chosen unit

crew heeling moment curve (either normal or if side decks smaller 0,4m)

heel angle [°]	insert righting arm / moment [Nm, kg m, m]	righting moment [Nm]	righting moment [kg m]	righting arm Gz [m]	crew heeling moment curve [N m]
0		#VALUE!	#VALUE!	error	FALSE
5		#VALUE!	#VALUE!	error	FALSE
10		#VALUE!	#VALUE!	error	FALSE
15		#VALUE!	#VALUE!	error	FALSE
20		#VALUE!	#VALUE!	error	FALSE
25		#VALUE!	#VALUE!	error	FALSE
30		#VALUE!	#VALUE!	error	FALSE
35		#VALUE!	#VALUE!	error	FALSE
40		#VALUE!	#VALUE!	error	FALSE
45		#VALUE!	#VALUE!	error	FALSE
50		#VALUE!	#VALUE!	error	FALSE

point of intersection of righting moment curve and crew heeling moment curve

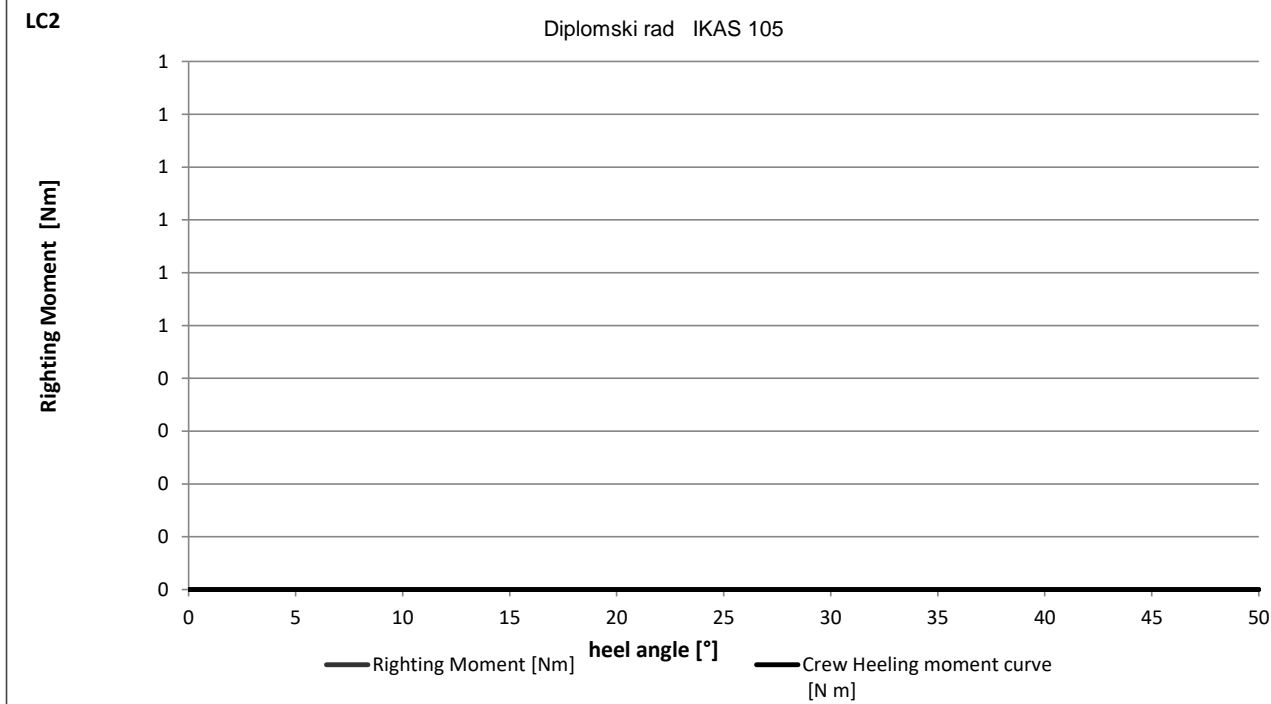

**ISO 12217-1:2017 CALCULATION WORKSHEET No. 6a RESISTANCE TO WAVES+WIND**

Diplomski rad IKAS 105

**Input data:**

**Design categories A and B only**

Item	Symbol	Unit	$m_{LA}$	$m_{MO}$	Ref.
Mass in minimum operating condition	$m_{MO}$	kg		4795,00	3.4.3
Loaded arrival mass	$m_{LA}$	kg	5649,75		3.4.6
Displacement volume (= $m_{MO}/1025$ or $m_{LA}/1025$ )	$V_D$	m <sup>3</sup>	5,51	4,68	3.4.7
Windage area (of above water profile of boat)	$A_{LV}$	m <sup>2</sup>	14,26	14,64	3.3.7
Windage area to be used (not to be < 0.5 $L_H B_H$ )	$A'_{LV}$	m <sup>2</sup>	14,26	14,64	6.3.2
Length waterline	$L_{WL}$	m	9,26	8,96	3.3.2
Lever between centroids of above and below water areas	$h$	m	1,03	1,04	6.3.2
Draught of canoe body at the mid-point of the waterline length	$T_M$	m	0,59	0,55	
Downflooding angle	$\phi_{DA}$	degrees	50	48	3.2.2
Calculation windspeed	$v_W$	m/s	17	17	3.5.1

**ISO 12217-1:2017 CALCULATION WORKSHEET No. 6b RESISTANCE TO WAVES+WIND**

Diplomski rad IKAS 105

Rolling in beam waves and wind:

Design categories A and B only

Item	Symbol	Unit	m <sub>LA</sub>	m <sub>MO</sub>	Ref.
Second wind heel equilibrium angle		degrees	66,4	63,3	Fig. 6
Least value of $\phi_{DA}$ , $50^0$ or second wind heel equilibrium angle	$\phi_{A2}$	degrees	50,0	48,0	Fig. 6
Wind heeling moment (1) = $0.53 A'_{LV} h v_W^2$	$M_{W1}$	N-m	2250	2332	6.3.2
Wind heeling moment (2) = $0.30 A'_{LV} (A'_{LV} / L_{WL} + T_M) v_W^2$	$M_{W2}$		2633	2772	
Assumed roll angle Category A = $(25+20/V_D)$	$\phi_R$	degrees	n.a.	n.a.	6.3.2
Category B = $(20+20/V_D)$					
Area 1 (see fig. 6)	$A_1$	any	#VALUE!	#VALUE!	Fig. 6
Area 2 (see fig. 6)	$A_2$	any	7,58	6,24	Fig. 6
Ratio of $A_2/A_1$		--	#VALUE!	#VALUE!	6.3.2
Is ratio of $A_2/A_1$ greater than or equal to 1.0?	YES / NO		#VALUE!	#VALUE!	6.3.2

Resistance to waves:

Item	Symbol	Unit	m <sub>LA</sub>	m <sub>MO</sub>	Ref.
Least value of $\phi_{DA}$ , $50^0$ or second wind heel equilibrium angle		degrees	50,00	48,00	6.3.3
Heel angle when righting moment is maximum	$\phi_{GZMax}$	degrees	65,00	65,00	6.3.3
<b>IF <math>\phi_{GZMax}</math> is greater than or equal to <math>30^0</math></b>					
Max value of righting moment @ $30^0$ heel?	$RM_{30}$	kN m	11,52	9,69	6.3.3a)
Required value of righting moment		kN m	7,00	7,00	6.3.3a)
Is $RM_{30}$ greater than or equal to required max value?			PASS	PASS	6.3.3b)
Value of righting lever at $30^0 = RM_{30}/(9.806*mass)$	$GZ_{30}$	m	0,208	0,206	3.5.10
Required value of righting lever at $30^0$		m	0,20	0,20	6.3.3a)
Is $GZ_{30}$ greater than or equal to required max value?			PASS	PASS	6.3.3a)
<b>IF <math>\phi_{GZMax}</math> is less than <math>30^0</math></b>					
Max value of righting moment	$RM_{MAX}$	kN m	25,26	23,65	6.3.3b)
Required value of $RM_{MAX}$ ( $A = 750/\phi_{GZMax}$ , $B = 210/\phi_{GZMax}$ )		kN m	n.a.	n.a.	6.3.3b)
Is $RM_{MAX}$ greater than or equal to required max value?			n.a.	n.a.	6.3.3b)
Max value of righting lever = $RM_{MAX}/(9.806*mass)$	$GZ_{Max}$	m	0,45600	0,50300	3.5.10
Required max value of righting lever = $6/\phi_{GZMax}$		m	n.a.	n.a.	6.3.3b)
Is $GZ_{MAX}$ greater than or equal to the required max value? PASS / FAIL			n.a.	n.a.	6.3.3b)

**Design Category given: NB:** Boat must have ratio of  $A_2/A_1$  greater than or equal to 1.0, and also get PASS twice under resistance to waves.

#VALUE!



**ISO 12217-1:2017 CALCULATION WORKSHEET No. 6c curve of righting moment  $m_{LA}$**

Diplomski rad IKAS 105

insert curve of righting moment in 5° steps in one of following units:

chosen unit	<b>N m</b>	<b>kg m</b>	<b>m</b>
	m		
chose of $M_w$	<b>MW1</b>		

heel angle [°]	insert Righting Arm/Moment [Nm, kg m, m]	Righting Moment [Nm]	Righting Moment [kg m]	Arm Gz [m]	Wind Heeling moment curve [m]
-25	-0,165	-9.141	-932	-0,165	0,0406
-20	-0,147	-8.144	-831	-0,147	0,0406
-15	-0,124	-6.870	-701	-0,124	0,0406
-10	-0,093	-5.152	-525	-0,093	0,0406
-5	-0,048	-2.659	-271	-0,048	0,0406
0	0,014	776	79	0,014	0,0406
5	0,077	4.266	435	0,077	0,0406
10	0,121	6.704	684	0,121	0,0406
15	0,151	8.366	853	0,151	0,0406
20	0,174	9.640	983	0,174	0,0406
25	0,192	10.637	1.085	0,192	0,0406
30	0,208	11.524	1.175	0,208	0,0406
35	0,228	12.632	1.288	0,228	0,0406
40	0,253	14.017	1.429	0,253	0,0406
45	0,292	16.177	1.650	0,292	0,0406
50	0,363	20.111	2.051	0,363	0,0406
55	0,425	23.546	2.401	0,425	0,0406
60	0,455	25.208	2.571	0,455	0,0406
65	0,456	25.263	2.576	0,456	0,0406
70	0,436	24.155	2.463	0,436	0,0406

**area A1 and A2 limits**

heel degrees		heel degrees	
A1 from	#VALUE!	to	2,11 below $M_w$
A2 from	2,11	to	50,00 above $M_w$

**point of intersection of righting moment curve and wind heeling moment curve**

$\Phi_w$
2,112

$M_w$	2250	Nm
$M_w$	229,4	kg m
$M_w$	0,041	m
$\Phi_w$	2,11	degrees
$\Phi_{A2}$	50,00	degrees
$\Phi_R$	n.a.	degrees

Max $m_{LA}$	0,456	m
heel at GZ max	65,00	degrees

**INTERNATIONAL MARINE CERTIFICATION INSTITUTE**  
INTERNATIONAL NON-PROFIT ASSOCIATION



Heeling arm curve  $m_{LA}$

Diplomski rad IKAS 105

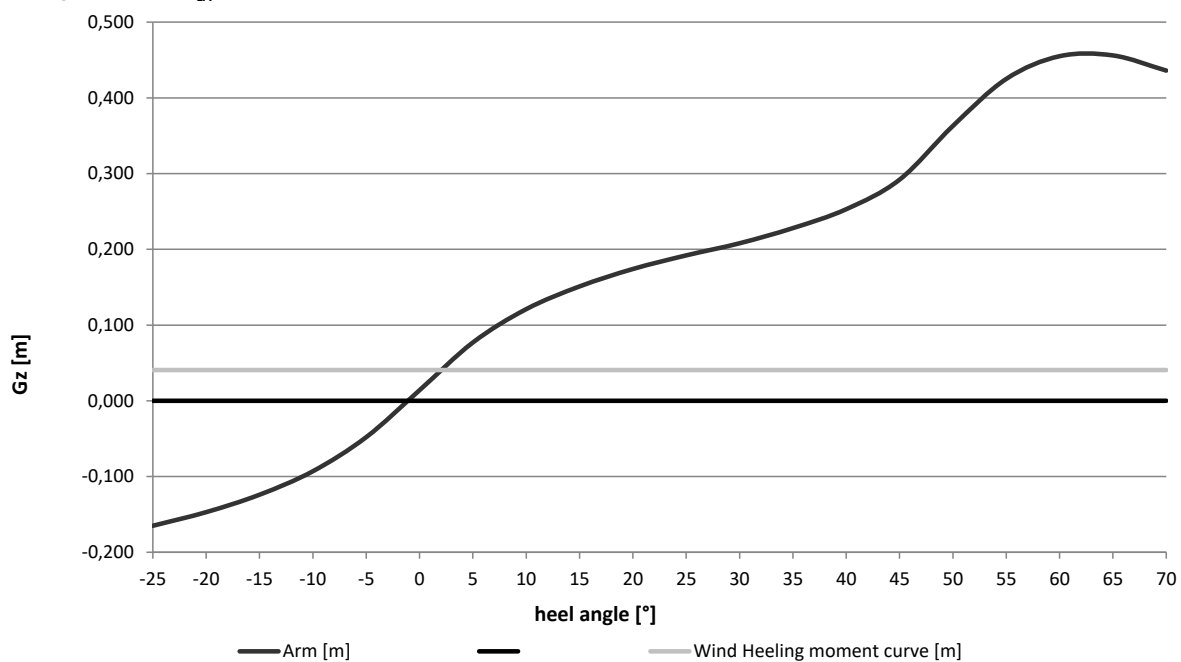

**ISO 12217-1:2017 CALCULATION WORKSHEET No. 6d curve of righting moment  $m_{MO}$**

Diplomski rad IKAS 105

insert curve of righting moment in 5° steps in one of following units:

	<b>N m</b>	<b>kg m</b>	<b>m</b>
chosen unit	m		
chose of $M_w$	MW1		

heel angle [°]	insert Righting Arm/Moment [Nm, kg m, m]	Righting Moment [Nm]	Righting Moment [kg m]	Arm Gz [m]	Wind Heeling moment curve [m]
-25	-0,23	-10.815	-1.103	-0,230	0,0496
-20	-0,208	-9.780	-997	-0,208	0,0496
-15	-0,181	-8.511	-868	-0,181	0,0496
-10	-0,145	-6.818	-695	-0,145	0,0496
-5	-0,096	-4.514	-460	-0,096	0,0496
0	-0,026	-1.223	-125	-0,026	0,0496
5	0,044	2.069	211	0,044	0,0496
10	0,093	4.373	446	0,093	0,0496
15	0,13	6.113	623	0,130	0,0496
20	0,159	7.476	762	0,159	0,0496
25	0,183	8.605	877	0,183	0,0496
30	0,206	9.686	988	0,206	0,0496
35	0,232	10.909	1.112	0,232	0,0496
40	0,265	12.460	1.271	0,265	0,0496
45	0,311	14.623	1.491	0,311	0,0496
50	0,378	17.773	1.813	0,378	0,0496
55	0,452	21.253	2.167	0,452	0,0496
60	0,492	23.134	2.359	0,492	0,0496
65	0,503	23.651	2.412	0,503	0,0496
70	0,492	23.134	2.359	0,492	0,0496

**area A1 and A2 limits**

heel degrees		heel degrees	
A1 from	#VALUE!	to	5,57
A2 from	5,57	to	48,00
			below $M_w$
			above $M_w$

**point of intersection of righting moment curve and wind heeling moment curve**

$\Phi_w$
5,571

$M_w$	2332	Nm
$M_w$	237,8	kg m
$M_w$	0,050	m
$\Phi_w$	5,57	degrees
$\Phi_{A2}$	48,00	degrees
$\Phi_R$	n.a.	degrees

Max $m_{MO}$	0,503	m
heel at GZ max	65,00	degrees

**INTERNATIONAL MARINE CERTIFICATION INSTITUTE**  
INTERNATIONAL NON-PROFIT ASSOCIATION



Heeling arm curve  $m_{Mo}$

Diplomski rad IKAS 105

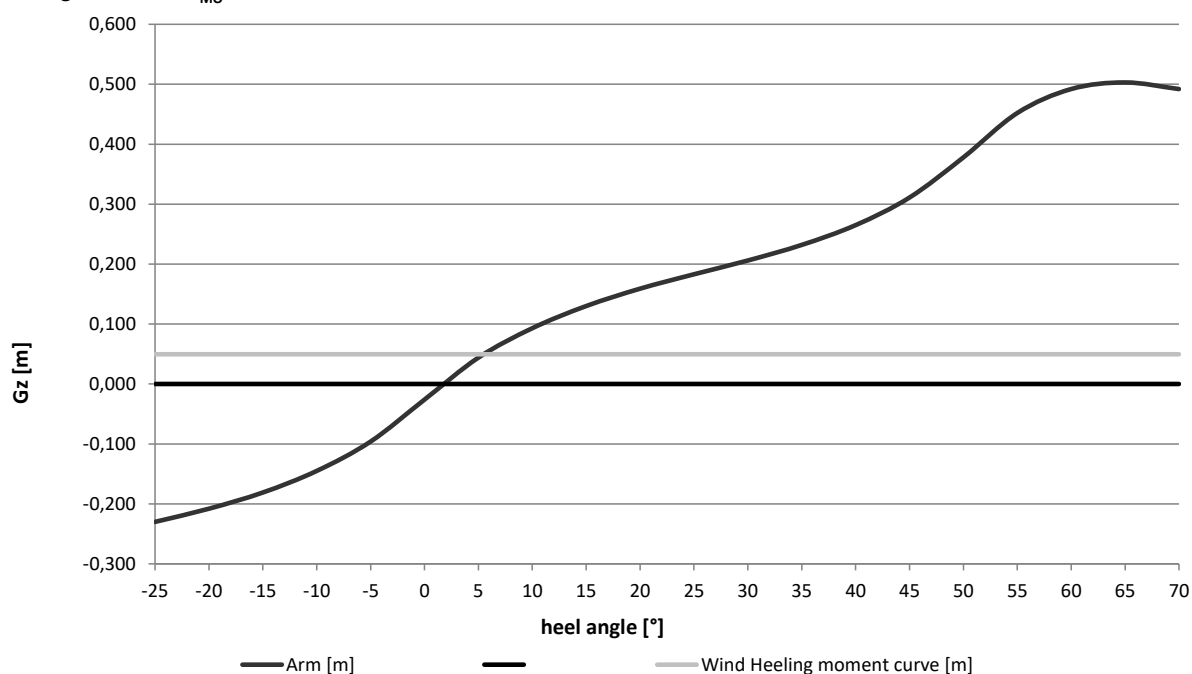

ISO 12217-1:2017 CALCULATION WORKSHEET No.7

HEEL DUE TO WIND ACTION

Diplomski rad IKAS 105

**NB: This sheet is to be completed for both Minimum Operating and Loaded arrival condition**

Initial check:

Design Categories C and D only

Item	Symbol	Unit	m <sub>LA</sub>	m <sub>MO</sub>	Ref.
Windage area (NOT subject to minimum of 0.5 L <sub>H</sub> B <sub>H</sub> )	A <sub>LV</sub>	m <sup>2</sup>		14,64	3.3.7
Length of Hull	L <sub>H</sub>	m	10,50	10,50	3.3.2
Beam of hull	B <sub>H</sub>	m	3,20		3.3.3
Ratio A <sub>LV</sub> /(L <sub>H</sub> B <sub>H</sub> ) at m <sub>MO</sub>		-----	0,44		
Is ratio A <sub>LV</sub> /(L <sub>H</sub> B <sub>H</sub> ) equal to or greater than 0.5?			No		6.4
If answer is NO, no other assessment is required.					

Calculation of wind heeling moment:

Item	Symbol	Unit	m <sub>LA</sub>	m <sub>MO</sub>	Ref.
Length of waterline	L <sub>WL</sub>	m			3.3.2
Draught at the mid-point of L <sub>WL</sub>	T <sub>M</sub>	m			6.3.2
Lever between centroids of above and below water areas	h	m			6.3.2
Calculation wind speed	v <sub>W</sub>	m/s	17		3.5.1
Wind heeling moment M <sub>W1</sub> = 0.53 A <sub>LV</sub> h v <sub>W</sub> <sup>2</sup>	M <sub>W</sub>	Nm	0	0	6.4.2
Wind heeling moment M <sub>W2</sub> = 0.3 A <sub>LV</sub> (A <sub>LV</sub> / L <sub>WL</sub> + T <sub>M</sub> ) v <sub>W</sub> <sup>2</sup>	M <sub>W</sub>	Nm	#DIV/0!	#DIV/0!	6.4.2

Angle of heel due to wind:

Item	Symbol	Unit	m <sub>LA</sub>	m <sub>MO</sub>	Ref.
FROM RIGHTING MOMENT CURVE: angle of heel due to wind	φ <sub>W</sub>	degrees	2,11	5,57	6.4.3
OR ALTERNATIVELY: wind heeling moment M <sub>W</sub> divided by 9.806	M <sub>W</sub>	kg.m	0	0	
Angle of heel due to wind when moment above applied	φ <sub>W</sub>	degrees			6.4.3
Maximum permitted angle of heel during offset load test (from worksheet 5b)	φ <sub>O(R)</sub>	degrees	16,23		6.2.3
Downflooding angle	φ <sub>DA</sub>	degrees	50	48	3.2.2
Maximum permitted angle of heel due to wind = lesser of 0.7φ <sub>O(R)</sub> and 0.7φ <sub>DA</sub>		degrees	11,4	11,4	6-4.3
Is angle of heel due to wind less than permitted value?			Pass	Pass	6.4.3
<b>Design Category possible on wind heeling =</b>					

**ISO 12217-1:2017 CALCULATION WORKSHEET No. 8**

Diplomski rad IKAS 105

**NB: This sheet is to be completed for the Loaded Arrival Condition.**

**calculation not applicable**

Please submit multiple copies of this page if applicable

		Recess	Ref.
<b>Further exemptions according to 6.5.1</b>			
Angle of vanishing stability > 90° ?	YES/NO	Yes	6.5.1a)
Over at least 35% of the periphery is the depth of the recess less than 3% of the max. breadth of the recess (e.g. toe rails, low bulwarks)	YES/NO		6.5.1b)
At least 5% of the bulwark area positioned within the lowest 25% of the bulwark height drains overboard and the bulwark height is less than 12,5% of the maximum breadth of the recess <i>(attention, req. 1) and 2) below must get also a "Yes" to fulfill all requirements)</i>	YES/NO		6.5.1c)
Unobstructed drainage area from the recess on each side of the boat centreline	m <sup>2</sup>		6.5.1d)
Volume of the recess to the recess retention level	m <sup>3</sup>		
Drainage area per side (m <sup>2</sup> ) divided by recess volume (m <sup>3</sup> )			6.5.1d)
Height position of drainage area (lowest 25% / lowest 50% / full depth)			6.5.1d)
Requirements of 6.5.1.d) fulfilled? <i>(attention, req. 1) and 2) below must get also a "Yes"</i>	YES/NO		6.5.1d)
1) the lower edge of the drainage openings are not more than 10 mm above recess sole height for at least 70 % of the width of each opening?	YES/NO	Yes	6.5.1 c) & d)
2) If drainage area is provided by an open or partially open transom, are the openings extend to the outboard sides of the recess sole on both sides?	YES/NO	Yes	6.5.1 c) & d)

Is recess exempt from size limit? If "yes", no further calculation required.			6.5.1
--	--	--	-------

**Calculation methods:**

Item	Symbol	Unit	Value	Ref.
			Recess	
<b>SIMPLIFIED METHOD:</b> Use 1), 2) or 3) below.				
Average freeboard to loaded waterline at aft end of recess	$F_A$	m		6.5.2.1
Average freeboard to loaded waterline at sides of recess	$F_S$	m		6.5.2.1
Average freeboard to loaded waterline at forward end of recess	$F_F$	m		6.5.2.1
Waterline length at mLA	$L_{WL}$	m		
Waterline breadth at mLA (for multihulls insert max. beam waterline $B_{WLmax}$ acc. to ISO 8666)	$B_{WL}/B_{WLmax}$	m		ISO 8666 4.3.4/5
Maximum length of recess at the retention level (see 3.5.11)	$l$	m		6.5.2.4
Maximum breadth of recess at the retention level (see 3.5.11)	$b$	m		6.5.2.4

*- In case of asymmetric recesses (e.g. bowrider, centercockpits, ...), please insert length and breadth of each area below; this allows a more exact calculation using simplified method 1) or 2)*

	max. length	max. breadth	Unit	% loss GMT (option 1)	% loss GMT (option 2)	Ref.
Maximum length and breadth of recess part A			m			6.5.2.2/3
Maximum length and breadth of recess part B			m			6.5.2.2/3
Maximum length and breadth of recess part C			m			6.5.2.2/3
Maximum length and breadth of recess part D			m			6.5.2.2/3
Maximum length and breadth of recess part E			m			6.5.2.2/3
Maximum length and breadth of recess part F			m			6.5.2.2/3
Maximum length and breadth of recess part G			m			6.5.2.2/3
Maximum length and breadth of recess part H			m			6.5.2.2/3
Maximum length and breadth of recess part I			m			6.5.2.2/3

to be continued on page 2

**ISO 12217-1:2017 CALCULATION WORKSHEET No. 8**

page 2

	Symbol	Unit	Value	Ref.
			Recess	
Average freeboard to recess periphery $= (F_A + 2F_S + F_F) / 4$	$F_R$	m	0	6.5.2.1
Category A permitted percentage loss in metacentric height $(GM_T) = 250 F_R / L_H$			n.a.	6.5.2.1
Category B permitted percentage loss in metacentric height $(GM_T) = 550 F_R / L_H$			n.a.	6.5.2.1
Category C permitted percentage loss in metacentric height $(GM_T) = 1200 F_R / L_H$			0	6.5.2.1

SIMPLIFIED METHOD: Use 1), 2) or 3) below.				Recess	
<b>1) Loss of <math>GM_T</math> used?</b>					6.5.2.1
Second moment of area of free-surface of recess	$SMA_{RECESS}$	$m^4$	0		6.5.2.2
Metacentric height of boat at $m_{LA}$	$GM_T$	m			6.5.2.2
Calculated percentage loss in metacentric height	$(GM_T) = \frac{102\ 500 \times SMA_{RECESS}}{m_{LA} \times GM_T}$				6.5.2.2
<b>2) Second moment of areas used?</b>					6.5.2.1
Second moment of area of free-surface of recess	$SMA_{RECESS}$	$m^4$	0		6.5.2.3
Second moment of area of waterplane of boat at $m_{LA}$	$SMA_{WP}$	$m^4$	0		6.5.2.3
Calculated percentage loss in metacentric height	$(GM_T) = \left( \frac{245 \times SMA_{RECESS}}{SMA_{WP}} \right)$				6.5.2.3
<b>3) Recess dimensions used?</b>					6.5.2.1*
Maximum length of recess at the retention level (see 3.5.11)	$l$	m	0		6.5.2.4
Maximum breadth of recess at the retention level (see 3.5.11)	$b$	m	0		6.5.2.4
Calculated percentage loss in metacentric height	$(GM_T) = 270 \left( \frac{l \times b^3}{L_H \times B_H^3} \right)^{0.7}$				6.5.2.4

<b>Requirement:</b> from results above, applied design category possible?	<b>Fail</b>	6.5.2.1
---	-------------	---------

DIRECT CALCULATION METHOD used?					6.5.3
Percentage full of water = $60 - 240 F/L_H$					6.5.3a)
Wind heeling moment for intended design category	$M_W$	N·m	#DIV/0!		6.5.3b)
Crew heeling moment at $\phi_{GZmax}$		N·m			6.5.3c)
Maximum swamped righting moment up to least of $\phi_D$ , $\phi_V$ or $50^\circ$		N·m			6.5.3d)
Required margin of righting moment over heeling moment		N·m	2824,875		6.5.3d)
Actual margin of righting moment over heeling moment		N·m			6.5.3d)

<b>Applied design category possible?</b>	<b>n.a.</b>	
--	-------------	--

Design category C boats using option 6			
Recess entirely contained within LH/2 of the bow ?			6.5.4
Volume to retention level (see 3.5.9) larger than $(L_H B_H F_M) / 40$ ?			6.5.4
If both questions are answered with 'yes' check requirements below:			
Recess is quickdraining recess either overboard or in the bilge?			6.5.4
Design category possible		<b>n.a.</b>	6.5.4

**ISO 12217-1:2017 CALCULATION WORKSHEET No. 9 Habitable Multihulls & Motor Sailers**

Diplomski rad IKAS 105

**Habitable Multihulls** Is boat habitable multihull acc. to cl. 3.1.8 ?

**NB: Boats complying with the other requirements of this standard for design categories A, B or D are not considered to be susceptible to inversion**

**Boats of design category C:**

Item	Symbol	Unit	Value	Ref.
Beam of hull	$B_H$	m	3,20	3.3.3
Volume of displacement in minimum operation condition	$V_D$	m <sup>3</sup>	4,68	3.4.7
Cube root of volume of displacement in $m_{MO}$	$V_D^{1/3}$	m	1,67	
Height of centroid of $A_{LV}$ above $m_{MO}$ waterline	$h_C$	m		6.6.3
Actual value of $h_C / B_H$	$h_C / B_H$	/		
Boat considered to be susceptible to inversion if either (10) or (11)				6.6.3
(10) when $V_D^{1/3} > 2,6$ and $h_C / B_H > 0,572$			n.a.	6.6.3
(11) when $V_D^{1/3} \leq 2,6$ and $h_C / B_H > 0,22 V_D^{1/3}$				6.6.3
<b>Is boat susceptible to inversion in design category C?</b>			No	
If 'Yes', boat must comply with ISO 12217-2, cl. 7.12 and cl. 7.13 (relevant ISO 12217-2 worksheets to be used)				6.6.1
Boat complies with ISO 12217-2, cl. 7.12 buoyancy when inverted?		Yes / No		6.6.1a)
Boat complies with ISO 12217-2, cl. 7.13 escape after inversion?		Yes / No		6.6.1b)

**Motor Sailer** Is boat defined as "non-sailing" ?   
 Is boat fitted with mast and sails?

**NB: Only applicable to non-sailing boats with sails of design cat A or B**

Item	Symbol	Unit	Value	Ref.
Sum of the windage area as defined in 3.3.7 plus the actual profile area, including overlaps, of the largest sail plan suitable for windward sailing in true winds of more than 10 kn to 12 kn (5,1 m/s to 6,2 m/s) and supplied or recommended by the builder as standard;	$A_{max}$	m <sup>2</sup>		6.7.2
Vertical distance between the geometric centres of $A_{max}$ and underwater profile area	$h$	m		6.7.2
Wind speed, 18 m/s for category A and 14 m/s for category B	$v_W$	m/s	n.a.	6.7.2
Heeling moment due to wind ( $M_W = 0,53 A_{max} h v_W^2$ )	$M_W$	Nm	#VALUE!	6.7.2
Maximum righting moment of the boat in $m_{LA}$ up to $\Phi_{DA}$	$RM_{max1}$	Nm	20.111	3.5.11
<b>Wind heeling moment <math>M_W</math> less than 50% of <math>RM_{max1}</math> ?</b>			#VALUE!	6.7.2



**ISO 12217-1:2017 CALCULATION WORKSHEET No.10 FLOTATION TEST**

Diplomski rad IKAS 105

**Annexes E and F**

**assumed Crew Limit (CL) = 10**

*theoretical calculation method used, calculation attached?*

**Preparation**

Item	Unit	Response	Ref.
Mass equal to 25% of dry stores and equipment added?			F.2 a)
Inboard or outboard engine fitted?			
If inboard fitted, correct engine replacement mass fitted?			F.2 d)
Assumed outboard engine power?	Kw	460	F.2 c)
Mass fitted to represent outboard engine, controls, and battery.	kg	900	Tables F.1 and F.2
Portable fuel tanks removed and/or fixed tanks are filled?			F.2 f)
Cockpit drains open and drain plugs are fitted?			F.2 g)
Void compartments which are not air tanks are opened?			F.2 i)
Number of integral air tanks required to be open?			Table F.3
Type of test weights used: lead, 65/35 brass, steel, cast iron, aluminum			F.3.2
Material factor <i>d</i>		Failure	Table F.4

**Swamped stability test:**

Item	Unit	Response	Ref.
Dry mass of test weights = $6dCL$ but $\geq 15d$	kg	#VALUE!	Table F.6
Test weight hung from gunwale each of four positions in turn?			F.3.1
5 min after swamping, boat heels less than $45^{\circ}$			F.3.4 + F.3.5

**Swamped buoyancy test:**

Item	Unit	Response	Ref.
<b>Load test:</b>			F.4
Design Category assessed		C	
Dry mass of test weights used	kg	#VALUE!	Table F.5
5 min after swamping, boat floats approximately level with more than 2/3 of periphery above water?			F.4.3

**Swamped buoyancy test (for design cat B only)**

Item	Unit	Response	Ref.
Total buoyant volume according to Iso 6185-4:2011, clause 7.6.1 and 7.6.2	m <sup>3</sup>		F.4.4; ISO 6184-4
1,33 m <sub>LDC</sub> / 1000	t	8,186815	3.4.5
Total buoyant volume > 1,33 m <sub>LDC</sub> /1000 ?		n.a.	F.4.4

**Flotation material and elements:**

Item	Response	Ref.
All flotation elements comply with all requirements?		Table G.1

<b>Design Category given: NB: boat must obtain PASS in all above tables</b>	<b>Fail</b>
---	-------------

**ISO 12217-1:2017 CALCULATION WORKSHEET No. 11 DETECTION + REMOVAL OF WATER**

Diplomski rad IKAS 105

Item	response	Ref.
The internal arrangement facilitates the drainage of water to bilge suction point(s), to a location from which it can be bailed rapidly, or directly overboard?	Yes	6.9.1
Is boat provided with a means of removing water from the bilges in accordance with 15083?	Yes	6.9.2
Table 2 option used for assessment:	2	6.9.3; 5.4 table 2
Can water in boat be detected from helm position?		6.9.3
Methods used: direct visual inspection		6.9.3
transparent inspection panels		6.9.3
bilge alarms		6.9.3
indication of the operation of automatic bilge pumps		6.9.3
other means (specify):		6.9.3

ISO 12217-1:2017 en220801

CALCULATION WORKSHEET No.12

SUMMARY

<b>Design Description:</b>	Diplomski rad IKAS 105		
<b>Design Category intended:</b>	C	<b>Crew Limit:</b>	10
		<b>Date:</b>	2023-09-14

Sheet	Item	Symbol	Unit	Value		
	<b>Length of hull:</b> (as in ISO 8666)	$L_H$	m	10,50		
	<b>Length of waterline in loaded arrival condition</b>	$L_{WL}$	m	9,26		
	<b>Beam of hull:</b> (as in ISO 8666)	$B_H$	m	3,20		
	<b>Masses:</b>					
1	Empty craft mass	$m_{EC}$	kg	1831		
	Maximum load	$m_L$	kg	1561		
	Maximum load for the builder's plate acc. to ISO 14945:2021	$m_{MBP}$	kg	1000		
	Number of portable tanks included in builder's plate weight			0		
	Light craft condition mass	$m_{LC}$	kg	4595		
	Maximum Loaded condition mass = $m_{LC} + m_{ML}$	$m_{LDC}$	kg	6156		
	Loaded arrival condition mass	$m_{LA}$	kg	5650		
	Minimum operating condition mass	$m_{MO}$	kg	4795		
1	<b>Is boat sail or non-sail?</b>	SAIL/NON-SAIL		NON-SAIL		
2	<b>Option selected:</b>	2				
3	<b>Downflooding openings:</b>	Are all requirements met?			Pass	
		Watertightness test for closing appliances done successful?			Pass	
		Exemptions ok or openings considered as possible downflooding openings?			n.a.	
3	<b>Downflooding angle:</b> (Categories A and B only)	degrees	Required	$m_{MO}$	$m_{LA}$	Pass/Fail
		degrees	n.a.	48	50	n.a.
3 & 4	<b>Downflooding height:</b> Worksheet employed for basic height	exempted acc. to 6.1.2.1?		0		
	basic requirement	m	0,62	1,56	Pass	
	reduced height for small openings (only using figures)	m	0,46	1,56	Pass	
	reduced height at outboard (options 3, 4, 6 only)	m	n.a.	1,56	n.a.	
	increased height at bow (options 3, 4, 6 only)	m	n.a.	1,56	n.a.	
5	<b>Off-set load test:</b>	<b>Unit</b>	<b>Required</b>	<b>Actual</b>	<b>Pass/Fail</b>	
	Testing for least stability: maximum heel angle	degrees	< 16,23	2,00	Pass	
	Testing for least freeboard: heeled freeboard margin	m	> 0,15	0,15	Pass	
	Maximum crew limit for stability			10		
	Maximum crew limit for freeboard			10		
6	<b>Resistance to waves and wind:</b> (options 1, 3) at $m_{LA}$ and $m_{MO}$					
	<b>Rolling in beam waves and wind:</b> ratio $A_2/A_1$	-	$\geq 1.0$	#VALUE!	#VALUE!	n.a.
	Resistance to waves: value of $\sigma_{GZ_{MAX}}$	degrees	---	65,00	65,00	
	value of $RM_{30}$ or $RM_{MAX}$	kNm	7	11,52	9,69	n.a.
	value of $GZ_{30}$ or $GZ_{MAX}$	m	0,2	0,21	0,21	n.a.

7	<b>Heel due to wind:</b> (options 2,4,5,6) at $m_{LA}$ and at $m_{MO}$					n.a.
	at $m_{MLA}$ : heel angle due to wind	degrees	<		2,11	n.a.
	if required at $m_{MO}$ : heel angle due to wind	degrees	<	5,57		n.a.
8	<b>Recess size:</b> (options 1 and 2 except category D)					
	Simplified method: max reduction in $GM_T$	%	≤	0		n.a.
	Direct calculation: margin righting moment over heeling moment	N m	≥	2824,875		n.a.
	For category C boats using option 6; drainage requirements for recesses entirely contained within LH/2 of the bow are fulfilled?					n.a.
9	<b>Habitable Multihulls:</b> Is Category C boat vulnerable to inversion?			Yes / No		
	Complies with Part 2 clause 7.12 for inverted buoyancy?			Pass / Fail		
	Complies with Part 2 clause 7.13 for means of escape?			Pass / Fail		
9	<b>Motor Sailers</b> Complies with requirement for excess of $RM_{MAX}$ over $M_W$ ?			Pass / Fail		
10	<b>Flotation test:</b> (options 3 and 4 only) All preparations completed?			Yes / No		n.a.
	<b>Swamped stability:</b> 5 min after swamping, does boat heel less than 45°?			Pass / Fail		n.a.
	<b>Load test:</b> 5 min after swamping, does boat float level with 2/3 periphery showing?			Pass / Fail		n.a.
	<b>Swamped buoyancy,</b> for boats using option 3: Total buoyant volume > $1,33 m_{LDC} / 1000$ ?			Pass / Fail		n.a.
	<b>Flotation elements:</b> do all elements comply with all the requirements?			Pass / Fail		n.a.
11	<b>Detection &amp; removal of water</b> are all requirements satisfied?			Yes / No		Yes
<b>NB:</b> Boat must pass all requirements applicable to selected option to be given intended Design Category.						
<b>Design Category given:</b>	<b>C</b>	Assessed by:	<b>Ivan Kašikić</b>			

Documentation of downflooding opening / closing appliance (photo/drawing) attached?

If applicable, cockpit calculation according to ISO 11812 attached ?

If applicable, curve of righting moments in  $m_{MO}$  and  $m_{LA}$  attached ?

Appropriate add. information attached (e.g. photos, drawings,...) ?

If applicable, ISO 12216 calculation attached?

Signature: \_\_\_\_\_

PRILOG 4

PROJEKTNA NORMA EN ISO 12217-1:2017

B I C KATEGORIJA

IZVEDBA SA IZVANBRODSKIM POGONSKIM SUSTAVOM

## ISO 12217-1:2017 NON-SAILING BOATS OF LENGTH GREATER THAN OR EQUAL TO 6m

Manufacturer:	Diplomski rad
Signatory, Name:	Ivan Kašikić
Signatory, Title:	Izvanbrodski pogonski sustav
Phone:	
Email:	
WWW:	
CIN Model Year:	
Model Name:	IKAS 105

*This calculation sheet is provided by IMCI "as is" and any express or implied warranties, including, but not limited to, the implied warranties of fitness for a particular purpose are disclaimed.*

blue cells are derived values
-------------------------------

yellow cells require data input
---------------------------------

Please make sure to set your signature on the summary! (worksheet 12)  
either digitally or print summary, sign and attach scan

- most worksheets have additional comments / remarks / other calculations beside the printout area; please take into account.

- For boats in category A and B either fill in worksheet 6c and 6d or attach curve of righting moments for both loading conditions to the documentation.

- For boats with quick-draining cockpit the cockpit calculation according to ISO 11812 shall be enclosed to the documentation.

- Please attach other detailed information as appropriate, e.g. photos, sketches etc. for sill height, openings, companion way doors, location of flooding points, practical tests etc.

- When entering data, please use the correct separator for your Excel version, many application problems are the result of incorrect separators ( , or . )

- Please send questions, found errors, typos, mistakes, ect. directly to ralf.dewender@imci.org or to the headoffice with info@imci.org; every comment helps us to provides you with a better version

- Please be aware that there is NO technical difference between the requirements of ISO 12217-1:2015 and EN ISO 12217-1:2017; change of the name is just because of the harmonisation process; for ISO 12217-1:2020 the main change is the exclusion of optional equipment and margin for future additions from the maximum load and the result of the "maximum recommended load for builder's plate" (with ISO 14945:2021 and ISO 14946:2021 renamed to "maximum load for the builder's plate,  $m_{MBP}$ ") which exludes OB engine weights and the optional equipment.

**ISO 12217-1:2017 NON-SAILING BOATS OF LENGTH GREATER THAN OR EQUAL TO 6m  
CALCULATION WORKSHEET No. 1**

ISO 12217-1:2017 en220801

Diplomski rad IKAS 105

Design Category intended:	B	Monohull / Multihull:	Monohull	Propul.Type:	OB
Item	Symbol	Unit	Value	Ref.	
Length of hull as in ISO 8666	$L_H$	m	10,50		3.3.1
Length of waterline in loaded arrival condition	$L_{WL}$	m	9,06		3.3.2
<u>Empty Craft condition mass</u>	$m_{EC}$	kg	1831,0		3.4.1
standard equipment (incl. OB engine(s) and ess. safety equipment)		kg	1805,0		3.5.12
water ballast in tanks which are notified in the owner's manual to be filled when the boat is afloat		kg	0,0		3.4.2
Light craft condition mass	$m_{LC}$	kg	3636,0		3.4.2
<b>Mass of:</b>					
Desired crew limit	CL	----	10		3.5.3
Mass of:					
desired crew limit at 75 kg each		kg	750,0		
provisions + personal effects		kg	250,0		3.4.4
drinking water		kg	28,5		3.4.4
fuel		kg	304,0		3.4.4
lubricating and hydraulic oils		kg	19,0		3.4.4
black water		kg	47,5		3.4.4
grey water		kg	133,0		3.4.4
water ballast		kg	0,0		3.4.4
other fluids carried aboard		kg	28,5		3.4.4
stores, spare gear and cargo (if any)		kg	0,0		3.4.4
inflatable life raft(s) in excess of essential safety equipment		kg	0,0		3.4.4
other small boats carried aboard		kg	0,0		3.4.4
Maximum load = sum of above masses <b>using ISO ISO 12217-1:2020</b>	$m_L$	kg	1560,5		3.4.4
optional equipment and fittings not included in basic outfit		kg	0,0		3.4.4 / 3.4.5
Maximum load = sum of above masses <b>using ISO 12217-1:2017</b>	$m_L$	kg	1560,5		3.4.4
<u>Maximum Load condition mass</u>	$m_{LDC}$	kg	5196,5		3.4.5
Mass to be removed for loaded arrival condition		kg	505,8		3.4.6
<u>Loaded Arrival condition mass</u>	$m_{LA}$	kg	4690,8		3.4.6
Mass of:					
minimum number of crew weight according to 3.4.3		kg	150,0		3.4.3a)
non-consumable stores and equipment normally aboard		kg	50,0		3.4.3b)
inflatable life raft		kg			3.4.3
Load to be included in Minimum Operating Condition	$m'_L$	kg	200,0		3.4.3
<u>Light craft condition mass</u>	$m_{LC}$	kg	3636,0		3.4.2
Mass in the Minimum Operating Condition	$m_{MO}$	kg	3836,0		3.4.3
<u>Maximum load for the builder's plate using EN ISO 14946:2021 and EN ISO 14945:2021 (if manually reduced on Worksheet 1b the reduced value is shown)</u>	$m_{MBP}$	kg	1000,0		
<b>Is boat sail or non-sail?</b> Nominal sail area	$A_S^*$	m <sup>2</sup>	0,0		3.3.8
Sail area / displacement ratio = $A_S / (m_{LDC})^{2/3}$		----	0,0000		3.1.2
CLASSIFIED AS [non-sail if $A_S / (m_{LDC})^{2/3} < 0.07$ ]	SAIL/NON-SAIL ?		<b>NON-SAIL</b>		3.1.2
NB If NON_SAIL, continue using these worksheets, if SAIL, use ISO 12217-2					

## ISO 12217-1:2017 / ISO 14945:2021 CALCULATION WORKSHEET No.1b Builder's plate

Diplomski rad IKAS 105

Since 2021-12-09 EN ISO 14945:2021 and EN ISO 14946:2021 are harmonised!

The formerly 'Maximum recommended load for builder's plate' became '**Maximum load for the builder's plate**',  $m_{MBP}$ .

$m_{MBP}$  does not include the optional equipment anymore; also the weight of outboard engines is excluded from  $m_{MBP}$  and can be shown in a separated line on the plate.

Below you find two examples for the builder's plates with the maximum value for  $m_{MBP}$  calculated from the stability calculation on worksheet 1; one for craft powered by outboard engines, one for craft powered by inboard or sterndrive engines.

For portable tanks, please change the default 'yes' on the right side in 'no, portable tank'; the weight of the tank will be included in  $m_{MBP}$ .

Please be aware that ISO 14946:2021 allows in clause 6 that the maximum recommended load can be downrated or limited by the manufacturer at any time. Therefore you find an extra cell to enter a manual reduced value for the maximum load for the builder's plate.

Default outboard engine mass is calculated with the help of table F.1 from EN ISO 12217-1:2017; nevertheless the manufacturer can insert the actual engine mass the boat model is calculated with.

This is strongly recommended for engines with more than 164,2 kW which are outside the table range (means all 300, 350, 400, 450 and more HP outboard engines) !

Please be also aware that the design of these plates is just a proposal from EN ISO 14945, the manufacturer is free to change the design as long all requirements of the standard are fulfilled.

Item	Value	Unit	Ref.
Manually reduced value for the 'Maximum load for the builder's plate' $m_{MBP}$	1000	kg	EN ISO 14945, cl. 6, note 2
Maximum engine power of a single engine	230	kW	
Maximum number of engines	2		
Actual value of the max. outboard engine mass, (sum of all engines) as defined by the manufacturer and used for stability calculation (default value is table F.1 from ISO 12217-1:2017 value)	558	kg	EN ISO 12217-1:2017 table F.1

Please see builder's plate example with values calculated from worksheet 1 entries on next page:



Builder's plate information for craft powered by outboard engines -- Example

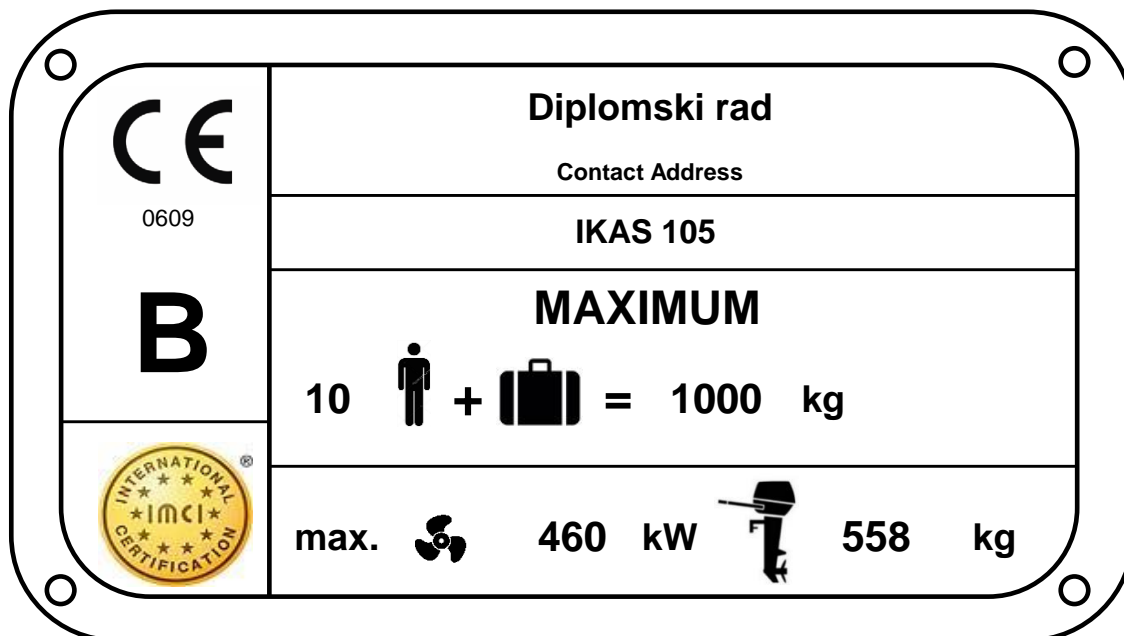

Builder's plate information for craft powered by inboard or sterndrive engines

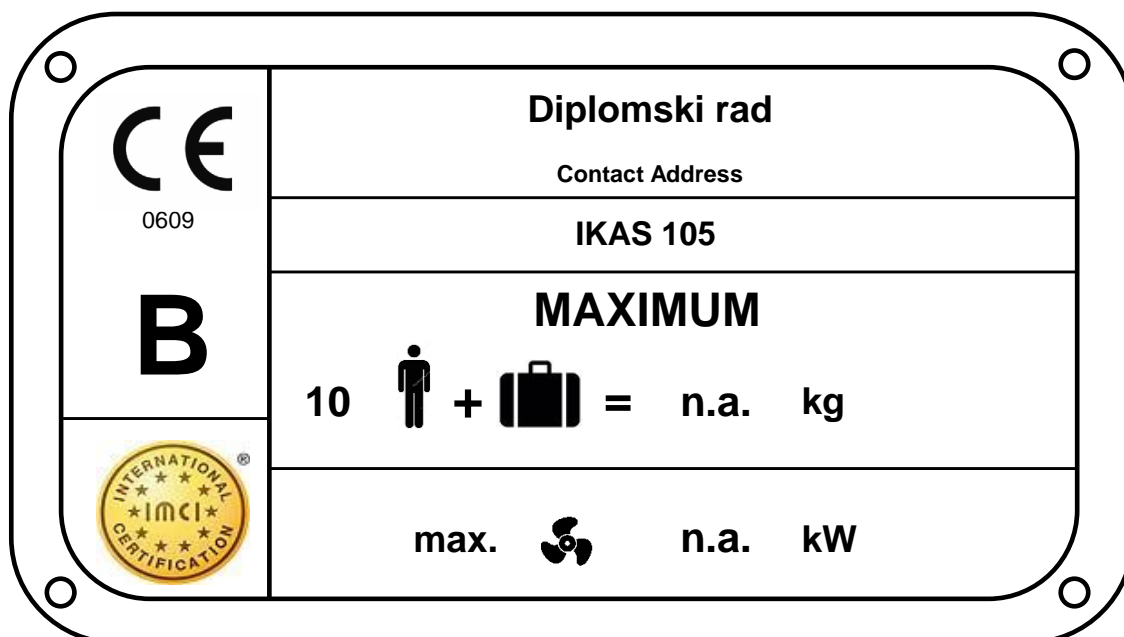

## ISO 12217-1:2017 CALCULATION WORKSHEET No.2 TESTS TO BE APPLIED

Diplomski rad IKAS 105

Question	Answer	Ref.
Is boat fully enclosed? (see definition in ref.) YES/NO?	Yes	3.1.6
Is boat partially protected? (see definition in ref.) YES/NO?	No	3.1.7

Item	Symbol	Unit	Value	Ref.
Windage area in minimum operating condition	$A_{LV}$	$m^2$	14,92	3.3.7
Length of Hull	$L_H$	m	10,50	3.3.2
Beam of hull	$B_H$	m	3,20	3.3.3
Freeboard at midships	$F_M$	m	1,48	3.3.5
Ratio $A_{LV}/(L_H B_H)$		---	0,44	

Choose any ONE of the following options and use all the worksheets indicated for that option.

Option	1	2	3	4	5	6
Categories possible	A and B	C and D	B	C and D	C and D	C and D
Decking or covering	fully enclosed	fully enclosed	any amount	any amount	partially protected	any amount
Downflooding openings	3	3	3	3	3	3
downflooding angle	3		3			
Downflooding height test	All boats	3	3	$3^a$	3	3
	Annex A method	4	4	$4^a$	4	4
Offset load test	5	5	5	5	5	5
Resistance to waves + wind	6		6			
Heel due to wind action		$7^b$		$7^b$	$7^b$	$7^b$
Recess size	8	$8^c$				$8^c$
Habitable multihulls	9	9	9	9	9	9
Motor sailers	9	9	9	9	9	9
Flotation test			10	10		
Flotation material			10	10		
Detection and removal of water	11	11	11	11	11	11
SUMMARY	12	12	12	12	12	12

a. The downflooding height test is not required to be conducted on the following Category C and D boats:

I. those which, when tested in accordance with normative annex F.4, have been shown to support, in addition to the mass required by F.2 and Table F.5, an additional equivalent dry mass (kg) of  $(75 \cdot CL + 10\%$  of dry weight of stores and equipment included in the maximum total load), or  
 II. those boats that do not take on water when heeled to  $90^\circ$  from the upright in the light craft condition.

b. The application of Worksheet 7 is only required for boats where  $A_{LV}/(L_H B_H) > 0,5$ .

c. Only required for boats of design category C; for option 6 clause 6.5.4 only

**Option selected**

**2**

**ISO 12217-1:2017 CALCULATION WORKSHEET No. 3 DOWNFLOODING**

Diplomski rad IKAS 105

**Downflooding Openings:**

Question	Answer	Ref.
Have all appropriate downflooding openings been identified?	Yes	3.2.1
Have potential downflooding openings within the boat been identified?	Yes	6.1.1.4
Do all closing appliances satisfy ISO 12216?	Yes	6.1.1.1
Hatches or opening type appliances are not fitted below minimum height above waterline? *	Yes	6.1.1.2
Seacocks comply with requirements?	Yes	6.1.1.3
Are all openings on design category A or B boats fitted with closing appliances? **	Yes	6.1.1.5
<b>Categories possible:</b> A or B if all are YES, C or D if first five are YES	<b>A</b>	6.1.1

\* Except for emergency escape hatches on design category C boats, where 0,1 m is allowable \*\* Except openings for ventilation and engine combustion

**Exemptions Downflooding Openings:**

Question	Answer	Ref.
Drains from quick-draining recesses or watertight recesses acc. to cl. 6.1.1.6 b) are either:		
1) freeing ports with non-return flaps which are watertight from the exterior (degree 3) <b>or</b>		6.1.1.6 b)
2) have a drainage area smaller than three times the minimum area required of ISO 11812		6.1.1.6 b)
		6.1.1.6 b)
Opening appliances (e.g. side doors) in the topsides which comply with ISO 12216 are		
1) referenced in the owner's manual as watertight closure to be kept shut when under way, <b>and</b>		6.1.1.6 d)
2) marked inboard with "KEEP SHUT WHEN ..." in upper case letters not less than 4,8 mm high, <b>and</b>		6.1.1.6 d)
3) the height above waterline of the lowest part is > 50% of required downflooding height		6.1.1.6 d)
		6.1.1.6 d)
All other exemptions of cl. 6.1.1.6 checked and requirements fulfilled?		6.1.1.6
		6.1.1.6

**Downflooding angle (required for cat A & B only\*):**

Item	Symbol	Unit	Value	Ref.
required Category A = larger of $(\phi_O + 25)^\circ$ or $30^\circ$	$\phi_{D(R)}$	degrees	n.a.	6.1.3; Table 3
( $\phi_O$ = angle from offset load test)				
required Category B = larger of $(\phi_O + 15)^\circ$ or $25^\circ$	$\phi_{D(R)}$	degrees	<b>25,00</b>	6.1.3; Table 3
Area of openings permitted to be submerged = $1.2 L_H B_H F_M$		cm <sup>2</sup>	<b>59,67</b>	6.1.3
<u>Actual downflooding angle:</u> at mass = $m_{MO}$	$\phi_{DA}$	degrees	<b>48</b>	6.1.3
at mass = $m_{LA}$	$\phi_{DA}$	degrees	<b>50</b>	6.1.3
Method used to determine $\phi_D$ :				Annex C
Design category possible on Downflooding Angle:			<b>B</b>	6.1.3

**Downflooding Height: (all exempt exempt boats)**

Requirement		Basic requirement	Reduced value for small openings	Reduced value at outboard	Increased value at bow
Is boat exempted from downflooding height requirements according to 6.1.2.1?		Yes / No			
Applicable to		all options	all options (using figures)	options 3, 4 or 6	options 3, 4, 6
ref.		6.1.2.2 a)	6.1.2.2 d)	6.1.2.2 c)	6.1.2.2 b)
obtained from Figs. 3 + 4 or annex A?		<b>fig 3 &amp; 4</b>	= basic x 0.75	= basic x 0.80	= basic x 1.15
Maximum area of small openings ( $50L_H^2$ ) (mm <sup>2</sup> ) =			5513	///////	///////
Required downflooding height $h_{D(R)}$	Fig. 3/ann. A	Category A	<b>0,62</b>	<b>0,46</b>	<b>0,49</b>
	Fig. 3/ann. A	Category B	<b>0,62</b>	<b>0,46</b>	<b>0,49</b>
	Fig. 3/ann. A	Category C			
	Fig. 4/ann. A	Category D			
<u>Actual Downflooding Height</u> $h_D$			<b>1,56</b>	<b>1,56</b>	<b>1,56</b>
Design Category possible		<b>B</b>	<b>B</b>		
Design Category possible on Downflooding Height = lowest of above					<b>B</b>

## ISO 12217-1:2017 CALCULATION WORKSHEET No.3a DOWNFLOODING OPENINGS / CLOSING APPLIANCES

Diplomski rad IKAS 105

### General overview downflooding openings and closing appliances

**NOTE:** All drawings are not blocked by a password, so please replace with own drawings if at hand.

**NOTE:** See X, Y, Z coordinates for worksheet 3b as illustrated below

Top View

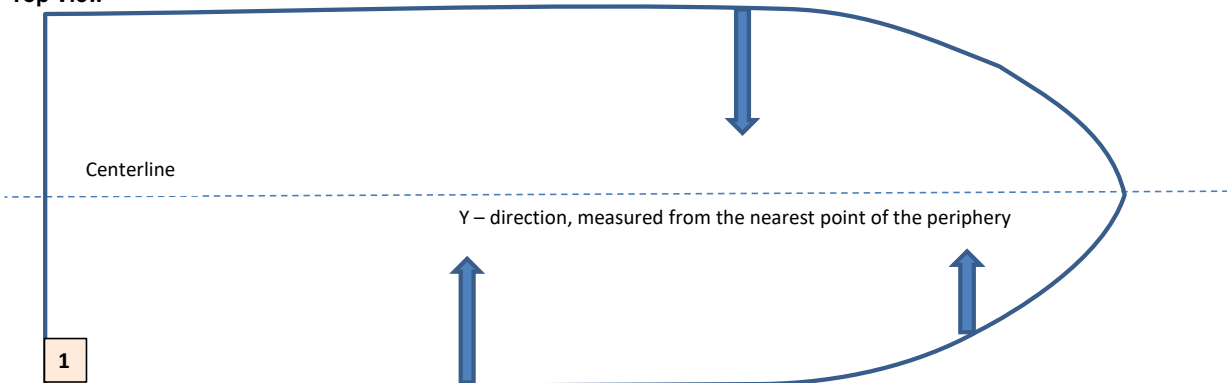

Side View Starboard

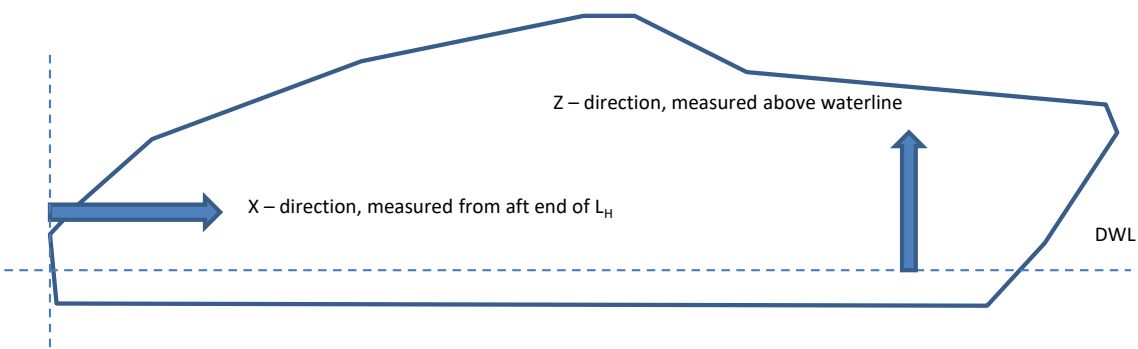

Side View Port

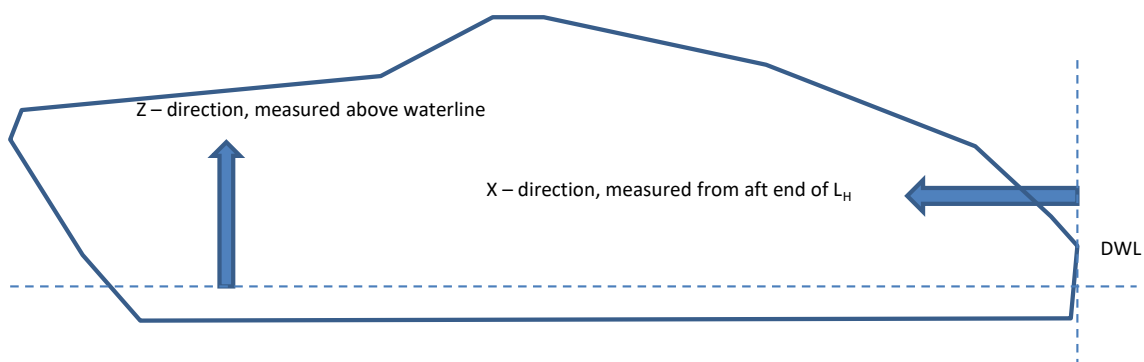

Please insert a short description and measurements of downflooding openings and closing appliances under the corresponding number on worksheet 3b

## ISO 12217-1:2017 CALCULATION WORKSHEET No.3b DOWNFLOODING OPENINGS

Diplomski rad IKAS 105

### General overview downflooding openings and closing appliances

**NOTE: Please submit for every pre-fabricated closing appliance a declaration of conformity (DoC) of the product. Please submit for every non pre-fabricated closing appliance a calculation acc. to ISO 12216 (see IMCI template). For both a watertightness test must be done!**

Description of the downflooding opening / closing appliance	Nr.	X <sup>(a)</sup> [m]	Y [m]	Z (=h <sub>D</sub> ) [m]	watertightness test done	opening type <sup>(b)</sup>
Razma	1	0,00	0,00	1,56	n.a.	downflooding opening
	2					
	3					
	4					
	5					
	6					
	7					
	8					
	9					
	10					
	11					
	12					
	13					
	14					
	15					
	16					
	17					
	18					
	19					
	20					
	21					
	22					

**(a)** Please be aware that X is measured from the aft end of L<sub>H</sub>.

In Annex A calculations x<sub>D</sub> is measured from the bow or stern, whichever is nearest

**(b)** opening types are: normal downflooding openings without any opening appliances; pre-fabricated opening appliances; non-pre-fabricated opening appliances and other devices

**ISO 12217-1:2017 CALCULATION WORKSHEET No.4 DOWNFLOODING HEIGHT**

Diplomski rad IKAS 105

**Calculation using annex A**

Item	Symbol	Unit	Opening 1	Opening 2	Opening 3	Opening 4
<b>Position of openings</b>						
Least longitudinal distance from bow/stern	$x_D$	m				
Least transvers distance from gunwale	$y_D$	m				
$F_1 = \text{greater of } (1 - x_D/L_H) \text{ or } (1 - y_D/B_H)$	$F_1$	----	1,00	1,00	1,00	1,00
<b>Size of openings:</b>						
Combined area of openings to top of any down-flooding opening	$a$	mm <sup>2</sup>				
Longitudinal distance of opening from tip of bow	$x'_D$	m				
Limiting value of $a = (30L_H)^2$		mm <sup>2</sup>	99225	99225	99225	99225
If $a \geq (30L_H)^2, F_2 = 1,0$						
If $a < (30L_H)^2, F_2 = 1 + \frac{x'_D}{L_H} \left( \frac{\sqrt{a}}{75 L_H} - 0,4 \right)$	$F_2$	----	1,00	1,00	1,00	1,00
<b>Size of recesses:</b>						
Volume of recesses which are not self-draining in accordance with ISO 11812	$V_R$	m <sup>3</sup>				
Is opening not a recess? Is recess quickdraining? Is recess not quickdraining?						
$k = V_R/(L_H B_H F_M)$	$k$	----	0	0	0	0
If opening is not a recess, $F_3 = 1$						
If recess is quickdraining, $F_3 = 0.7$	$F_3$	----	1,20	1,20	1,20	1,20
If recess is not quick draining, $F_3 = (0.7 + k^{0.5})$						
<b>Displacement:</b>						
Loaded displacement volume (see 3.4.5)	$V_D$	m <sup>3</sup>		5,07		
$B = B_H$ for monohulls, $B_{WL}$ for multihulls	$B$	m		3,2		
$F_4 = [(10 V_D)/(L_H B^2)]^{1/3}$	$F_4$	----		0,78		
<b>Flotation:</b>						
For boats using option 3 or 4, $F_5 = 0.8$						
For all other boats, $F_5 = 1.0$	$F_5$	----		1		
<b>Required calculation height: = <math>F_1 F_2 F_3 F_4 F_5 L_H / 15</math></b>	$h_{D(R)}$	m	0,65	0,65	0,65	0,65
Required downflooding height with limits applied (see annex A, Table A.1)	Category A	$h_{D(R)}$				
	Category B	$h_{D(R)}$	0,4	0,4	0,4	0,4
	Category C	$h_{D(R)}$				
	Category D	$h_{D(R)}$				
<b>Measured Downflooding Height:</b>	$h_D$	m				
<b>Design Category possible:</b>						
<b>Lowest of above =</b>						<b>Fail</b>

ISO 12217-1:2017 CALCULATION WORKSHEET - No. 5a

OFFSET LOAD TEST

Diplomski rad IKAS 105

Mass of people used for test

Name	Ident.	Mass (kg)
Person 1	A	85
Person 2	B	85
Person 3	C	85
Person 4	D	85
Person 5	E	85
Person 6	F	85
Person 7	G	85
Person 8	H	85
Person 9	I	85
Person 10	J	85

downflooding opening obvious to the crew?  Yes

Crew Area

Areas included and access limitations (if any):

Area	P/S	Incl?	Persons limit
Main Cockpit			
Aft Cockpit			
Fwd Cockpit			
Salon			
Cabins			
Side Decks			
Fore Deck			

Offset Load Test

Name	Ident.	Mass (kg)
Person 11	K	
Person 12	L	
Person 13	N	
Person 14	M	
Person 15	O	
Person 16	P	
Person 17	Q	
Person 18	R	
Person 19	S	
Person 20	T	

average mass per person:   
 number of persons permitted (through offset load test)

Area	P/S	Incl?	Persons limit
Cuddy Top			
Coachroof Top			
Wheelhouse Top			
Fly Bridge			
Swim Platform			

**Sketch:** Indicate possible seating locations along the length of the side to be tested using numbers, so that these may later be used to record the positions that people actually occupy. Locations should not be closer than 0.5 m between centers, and not less than 0.2 m from outboard edge unless on sidedecks less than 0.4 m wide.

1) Note whether it is asymmetric by adding P (port) or S (starboard) to denote the larger side.

**ISO 12217-1:2017 CALCULATION WORKSHEET - No. 5b**
**OFFSET-LOAD TEST**

Diplomski rad IKAS 105

**Stability Test - Full Procedure**

Boat being tested for:		x	stability	x	downflooding			please mark	
$L_H$ (m)	Min. permitted freeboard margin (m) (see Table 5)		Max. permitted heel angle (°) $= 11,5 + \frac{(24 - LH)^3}{520}$		Intended crew limit (CL)	Intended design category	Mass Test weights per person (kg) (Cat D only)	Max. Mass of test weights (kg) (= 98 x CL)	
10,50	n.a.		16,23		10	B		980	
Does boat have a list?		No		If "YES" to which side?					
Is crew area asymmetric?		Yes		If "YES" to which side?					
Is downflooding asymmetric?		No		If "YES" to which side?					
Boat tested:		to Port							

**Test Data:**

Mass ident.	Location		Mass (kg)	Total mass (kg)	Lever (m)	Moment (kg-m)	Heel angle (°) P/S	min. freeb'd (m)	
	area	fore & aft						fwd	aft
1			85	85	0,32	26,78			
2			85	170	0,13	11,05			
3			85	255	0,85	72,25			
4			85	340	0,82	69,70			
5			85	425	1,12	95,20			
6			85	510	0,82	69,70			
7			85	595	0,75	63,75			
8			85	680	0,75	63,75			
9			85	765	0,69	58,65			
10			85	850	0,69	58,65	2,00	0,16	0,16
11				850		0,00			
12				850		0,00			
13				850		0,00			
14				850		0,00			
15				850		0,00			
16				850		0,00			
17				850		0,00			
18				850		0,00			
19				850		0,00			
20				850		0,00			

total:	$\Sigma$	max. angle	min freeboard	
	589,48	2,00	0,16	0,16

Max. mass of people allowed per above:	850	hence CL =	10	at	85	kg / person
--	-----	------------	----	----	----	-------------

Design category given:	B
------------------------	---

Safety Signs Required:	Fig B1:	No	Fig B2:	No	Fig B3:	No
------------------------	---------	----	---------	----	---------	----



## ISO 12217-1:2017 CALCULATION WORKSHEET No. 5c Simplified procedure for OFFSET LOAD TEST

Diplomski rad IKAS 105

This method may only be applied by calculation; requirements must be fulfilled for both conditions LC1 and LC2

### Preparation (curves of moments in Nm)

Question	Answer	ref.
Mass and the centre-of-gravity of the boat calculated for conditions LC1 and LC2?		B.3.2.2
Curves of righting moments calculated according to annex E?		B.3.2.3
Crew heeling moment curve calculated with $961 CL (B_C/2 - 0,2) \cos \phi$ or where the crew area includes side decks less than 0,4m wide with $480 CL BC \cos \phi$ ?		B.3.2.4

### Test data:

item	symbol	unit	LC1	LC2	ref.
Maximum transverse distance between the outboard extremities of any part of the crew area	$B_C$	m			B.3.2.4 & B.3.1.7
Heel angle at the point of intersection between crew heeling moment curve and the curve of righting moment	$\phi_O$	degrees	0,00	0,00	B.3.2.5
Maximum permitted heel angle	$\phi_{O(R)}$	degrees	16,23		B.3.2.5
Value of downflooding angle	$\phi_{DA}$	degrees			B.3.2.5
Value of minimum freeboard margin at $\phi_O$	$h_F$	m			
Minimum required freeboard margin	$h_{F(R)}$	m	n.a.		6.2.2 table 4
Max. righting moment up to $\phi_{DA}$		Nm	#VALUE!	#VALUE!	
Crew heeling moment at $\phi_O$		Nm	FALSE	FALSE	

### Requirements:

Question	Answer	ref.
Is $\phi_O < \phi_{O(R)}$	Fail	B.3.2.5
Is $h_F > h_{F(R)}$	n.a.	B.3.2.5
Is the max. righting moment up to $\phi_{DA} >$ crew heeling moment at $\phi_O$ ?	#VALUE! #VALUE!	B.3.2.5
Offset load test passed, if all questions above are answered with 'yes' (or n.a.)	Pass/Fail #VALUE!	B.3.2.5

**ISO 12217-1:2017 CALCULATION WORKSHEET No. 5d curve of righting moment LC1**

Diplomski rad IKAS 105

insert curve of righting moment in 5° steps in one of following units:

**OFFSET LOAD TEST**

<b>N m</b>	<b>kg m</b>	<b>m</b>	<b>mLC1</b>	<b>5016,25</b>
<input type="checkbox"/> chosen unit <input type="checkbox"/> crew heeling moment curve (either normal or if side decks smaller 0,4m)				

heel angle [°]	insert righting arm / moment [Nm, kg m, m]	righting moment [Nm]	righting moment [kg m]	righting arm Gz [m]	crew heeling moment curve [N m]
0		#VALUE!	#VALUE!	error	FALSE
5		#VALUE!	#VALUE!	error	FALSE
10		#VALUE!	#VALUE!	error	FALSE
15		#VALUE!	#VALUE!	error	FALSE
20		#VALUE!	#VALUE!	error	FALSE
25		#VALUE!	#VALUE!	error	FALSE
30		#VALUE!	#VALUE!	error	FALSE
35		#VALUE!	#VALUE!	error	FALSE
40		#VALUE!	#VALUE!	error	FALSE
45		#VALUE!	#VALUE!	error	FALSE
50		#VALUE!	#VALUE!	error	FALSE

point of intersection of righting moment curve and crew heeling moment curve

$\Phi_c$

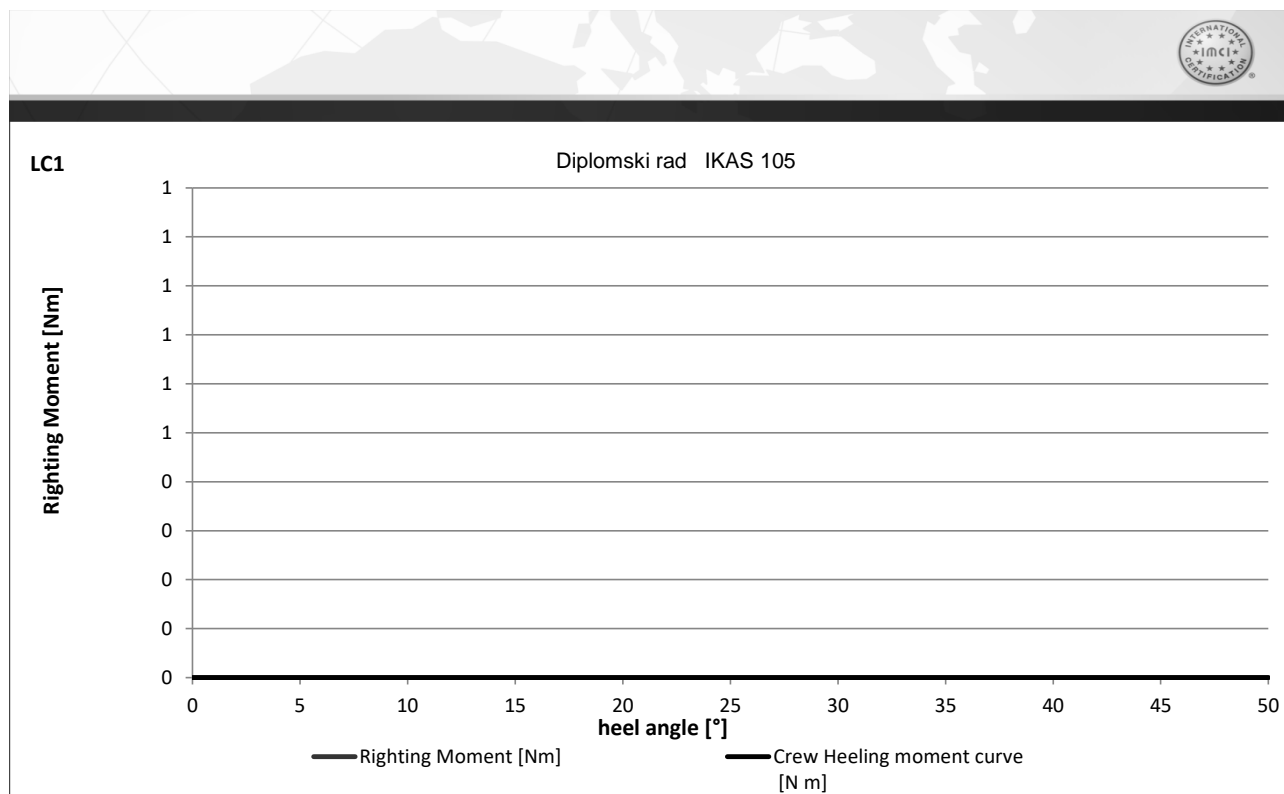



### ISO 12217-1:2017 CALCULATION WORKSHEET No. 5e curve of righting moment LC2

Diplomski rad IKAS 105

insert curve of righting moment in 5° steps in one of following units:

#### OFFSET LOAD TEST

*N m*      *kg m*      *m*

*mLC2*     

chosen unit

crew heeling moment curve (either normal or if side decks smaller 0,4m)

heel angle [°]	insert righting arm / moment [Nm, kg m, m]	righting moment [Nm]	righting moment [kg m]	righting arm Gz [m]	crew heeling moment curve [N m]
0		#VALUE!	#VALUE!	error	FALSE
5		#VALUE!	#VALUE!	error	FALSE
10		#VALUE!	#VALUE!	error	FALSE
15		#VALUE!	#VALUE!	error	FALSE
20		#VALUE!	#VALUE!	error	FALSE
25		#VALUE!	#VALUE!	error	FALSE
30		#VALUE!	#VALUE!	error	FALSE
35		#VALUE!	#VALUE!	error	FALSE
40		#VALUE!	#VALUE!	error	FALSE
45		#VALUE!	#VALUE!	error	FALSE
50		#VALUE!	#VALUE!	error	FALSE

point of intersection of righting moment curve and crew heeling moment curve

LC2

Diplomski rad IKAS 105

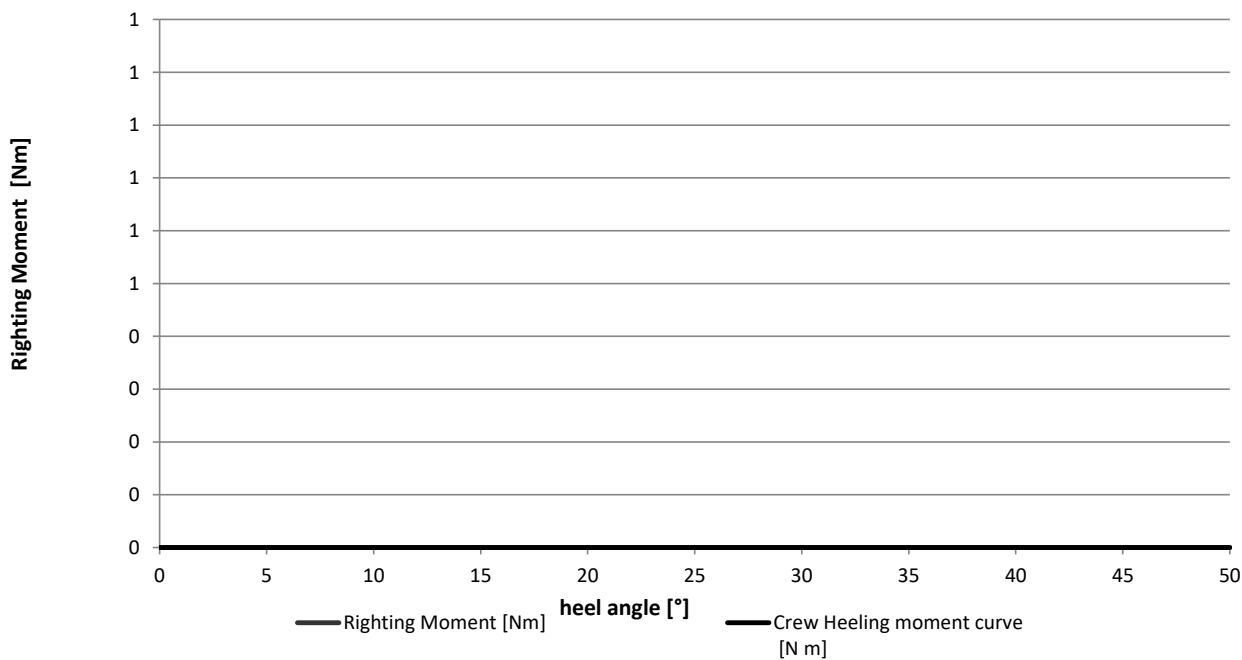

**ISO 12217-1:2017 CALCULATION WORKSHEET No. 6a RESISTANCE TO WAVES+WIND**

Diplomski rad IKAS 105

**Input data:**

**Design categories A and B only**

Item	Symbol	Unit	$m_{LA}$	$m_{MO}$	Ref.
Mass in minimum operating condition	$m_{MO}$	kg		3836,00	3.4.3
Loaded arrival mass	$m_{LA}$	kg	4690,75		3.4.6
Displacement volume (= $m_{MO}/1025$ or $m_{LA}/1025$ )	$V_D$	m <sup>3</sup>	4,58	3,74	3.4.7
Windage area (of above water profile of boat)	$A_{LV}$	m <sup>2</sup>	14,30	14,92	3.3.7
Windage area to be used (not to be < 0.5 $L_H B_H$ )	$A'_{LV}$	m <sup>2</sup>	16,80	16,80	6.3.2
Length waterline	$L_{WL}$	m	9,06	8,84	3.3.2
Lever between centroids of above and below water areas	$h$	m	1,02	1,04	6.3.2
Draught of canoe body at the mid-point of the waterline length	$T_M$	m	0,54	0,49	
Downflooding angle	$\phi_{DA}$	degrees	50	48	3.2.2
Calculation windspeed	$v_W$	m/s	21	21	3.5.1

**ISO 12217-1:2017 CALCULATION WORKSHEET No. 6b RESISTANCE TO WAVES+WIND**

Diplomski rad IKAS 105

Rolling in beam waves and wind:

Design categories A and B only

Item	Symbol	Unit	m <sub>LA</sub>	m <sub>MO</sub>	Ref.
Second wind heel equilibrium angle		degrees	64,5	62,3	Fig. 6
Least value of $\phi_{DA}$ , $50^0$ or second wind heel equilibrium angle	$\phi_{A2}$	degrees	50,0	48,0	Fig. 6
Wind heeling moment (1) = $0.53 A'_{LV} h v_W^2$	$M_{W1}$	N-m	4005	4084	6.3.2
Wind heeling moment (2) = $0.30 A'_{LV} (A'_{LV} / L_{WL} + T_M) v_W^2$	$M_{W2}$		5322	5313	
Assumed roll angle Category A = $(25+20/V_D)$	$\phi_R$	degrees	24,4	25,3	6.3.2
Category B = $(20+20/V_D)$					
Area 1 (see fig. 6)	$A_1$	any	2,44	0,96	Fig. 6
Area 2 (see fig. 6)	$A_2$	any	2,06	0,77	Fig. 6
Ratio of $A_2/A_1$		--	0,85	0,80	6.3.2
Is ratio of $A_2/A_1$ greater than or equal to 1.0?	YES / NO		NO	NO	6.3.2

Resistance to waves:

Item	Symbol	Unit	m <sub>LA</sub>	m <sub>MO</sub>	Ref.
Least value of $\phi_{DA}$ , $50^0$ or second wind heel equilibrium angle		degrees	50,00	48,00	6.3.3
Heel angle when righting moment is maximum	$\phi_{GZMax}$	degrees	65,00	65,00	6.3.3
<b>IF <math>\phi_{GZMax}</math> is greater than or equal to <math>30^0</math></b>					
Max value of righting moment @ $30^0$ heel?	$RM_{30}$	kN m	7,13	5,19	6.3.3a)
Required value of righting moment		kN m	7,00	7,00	6.3.3a)
Is $RM_{30}$ greater than or equal to required max value?			PASS	FAIL	6.3.3b)
Value of righting lever at $30^0 = RM_{30}/(9.806*mass)$	$GZ_{30}$	m	0,155	0,138	3.5.10
Required value of righting lever at $30^0$		m	0,20	0,20	6.3.3a)
Is $GZ_{30}$ greater than or equal to required max value?			FAIL	FAIL	6.3.3a)
<b>IF <math>\phi_{GZMax}</math> is less than <math>30^0</math></b>					
Max value of righting moment	$RM_{MAX}$	kN m	16,56	13,05	6.3.3b)
Required value of $RM_{MAX}$ ( $A = 750/\phi_{GZMax}$ , $B = 210/\phi_{GZMax}$ )		kN m	3,23	3,23	6.3.3b)
Is $RM_{MAX}$ greater than or equal to required max value?			n.a.	n.a.	6.3.3b)
Max value of righting lever = $RM_{MAX}/(9.806*mass)$	$GZ_{Max}$	m	0,36000	0,34700	3.5.10
Required max value of righting lever = $6/\phi_{GZMax}$		m	n.a.	n.a.	6.3.3b)
Is $GZ_{MAX}$ greater than or equal to the required max value? PASS / FAIL			n.a.	n.a.	6.3.3b)

**Design Category given: NB:** Boat must have ratio of  $A_2/A_1$  greater than or equal to 1.0, and also get PASS twice under resistance to waves.

**Fail**

**ISO 12217-1:2017 CALCULATION WORKSHEET No. 6c curve of righting moment  $m_{LA}$**

Diplomski rad IKAS 105

insert curve of righting moment in 5° steps in one of following units:

chosen unit	<b>N m</b>	<b>kg m</b>	<b>m</b>
	m		
chose of $M_w$	<b>MW2</b>		

heel angle [°]	insert Righting Arm/Moment [Nm, kg m, m]	Righting Moment [Nm]	Righting Moment [kg m]	Arm Gz [m]	Wind Heeling moment curve [m]
-25	-0,116	-5.336	-544	-0,116	0,1157
-20	-0,107	-4.922	-502	-0,107	0,1157
-15	-0,093	-4.278	-436	-0,093	0,1157
-10	-0,071	-3.266	-333	-0,071	0,1157
-5	-0,038	-1.748	-178	-0,038	0,1157
0	0,017	782	80	0,017	0,1157
5	0,071	3.266	333	0,071	0,1157
10	0,105	4.830	493	0,105	0,1157
15	0,126	5.796	591	0,126	0,1157
20	0,138	6.348	647	0,138	0,1157
25	0,147	6.762	690	0,147	0,1157
30	0,155	7.130	727	0,155	0,1157
35	0,166	7.636	779	0,166	0,1157
40	0,184	8.464	863	0,184	0,1157
45	0,216	9.935	1.013	0,216	0,1157
50	0,27	12.419	1.267	0,270	0,1157
55	0,33	15.179	1.548	0,330	0,1157
60	0,359	16.513	1.684	0,359	0,1157
65	0,36	16.559	1.689	0,360	0,1157
70	0,34	15.639	1.595	0,340	0,1157

**area A1 and A2 limits**

heel degrees		heel degrees	
A1 from	-11,82	to	12,55
A2 from	12,55	to	50,00
			below $M_w$
			above $M_w$

**point of intersection of righting moment curve and wind heeling moment curve**

$\Phi_w$
12,546

$M_w$	5322	Nm
$M_w$	542,7	kg m
$M_w$	0,116	m
$\Phi_w$	12,55	degrees
$\Phi_{A2}$	50,00	degrees
$\Phi_R$	24,37	degrees

Max $m_{LA}$	0,360	m
heel at GZ max	65,00	degrees

**INTERNATIONAL MARINE CERTIFICATION INSTITUTE**  
INTERNATIONAL NON-PROFIT ASSOCIATION



Heeling arm curve  $m_{LA}$

Diplomski rad IKAS 105

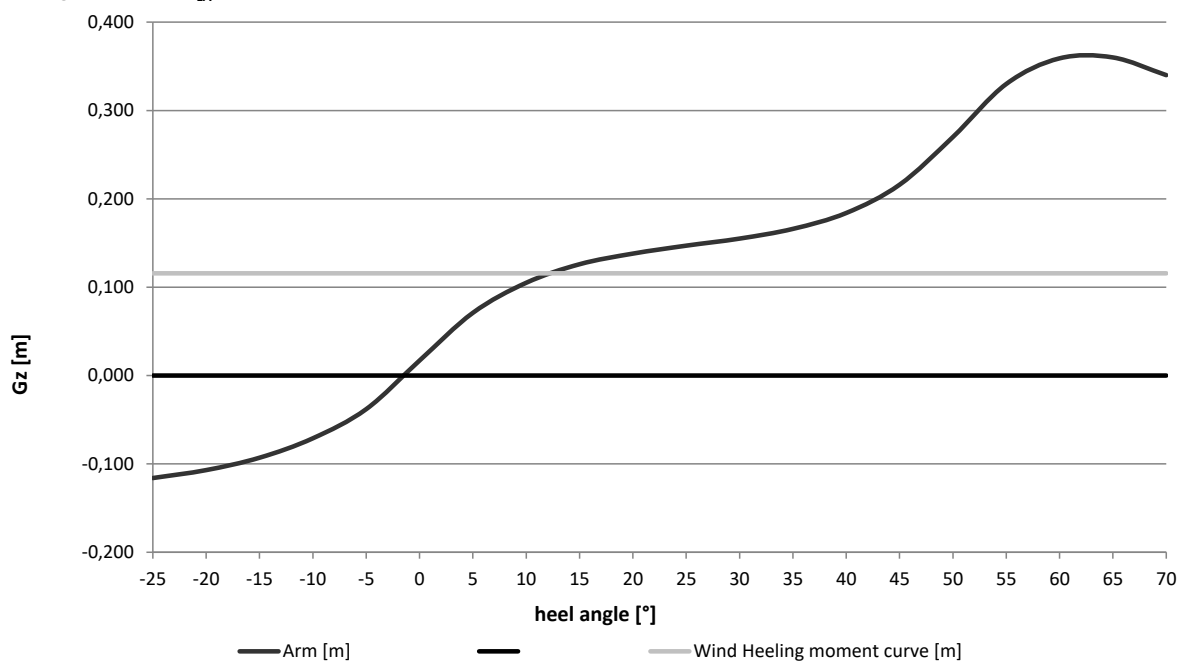

**ISO 12217-1:2017 CALCULATION WORKSHEET No. 6d curve of righting moment  $m_{MO}$**

Diplomski rad IKAS 105

insert curve of righting moment in 5° steps in one of following units:

	<b>N m</b>	<b>kg m</b>	<b>m</b>
chosen unit	m		
chose of $M_w$	MW2		

heel angle[°]	insert Righting Arm/Moment [Nm, kg m, m]	Righting Moment [Nm]	Righting Moment [kg m]	Arm Gz [m]	Wind Heeling moment curve [m]
-25	-0,147	-5.530	-564	-0,147	0,1412
-20	-0,135	-5.078	-518	-0,135	0,1412
-15	-0,119	-4.476	-456	-0,119	0,1412
-10	-0,096	-3.611	-368	-0,096	0,1412
-5	-0,06	-2.257	-230	-0,060	0,1412
0	-0,012	-451	-46	-0,012	0,1412
5	0,036	1.354	138	0,036	0,1412
10	0,072	2.708	276	0,072	0,1412
15	0,096	3.611	368	0,096	0,1412
20	0,112	4.213	430	0,112	0,1412
25	0,125	4.702	480	0,125	0,1412
30	0,138	5.191	529	0,138	0,1412
35	0,155	5.830	595	0,155	0,1412
40	0,18	6.771	690	0,180	0,1412
45	0,219	8.238	840	0,219	0,1412
50	0,261	9.818	1.001	0,261	0,1412
55	0,296	11.134	1.135	0,296	0,1412
60	0,332	12.488	1.274	0,332	0,1412
65	0,347	13.053	1.331	0,347	0,1412
70	0,34	12.789	1.304	0,340	0,1412

**area A1 and A2 limits**

heel degrees		heel degrees	
A1 from	5,61	to	30,95
A2 from	30,95	to	48,00
			below $M_w$
			above $M_w$

**point of intersection of righting moment curve and wind heeling moment curve**

$\Phi_w$
30,955

$M_w$	5313	Nm
$M_w$	541,8	kg m
$M_w$	0,141	m
$\Phi_w$	30,95	degrees
$\Phi_{A2}$	48,00	degrees
$\Phi_R$	25,34	degrees

Max $m_{MO}$	0,347	m
heel at GZ max	65,00	degrees



**INTERNATIONAL MARINE CERTIFICATION INSTITUTE**  
INTERNATIONAL NON-PROFIT ASSOCIATION



Heeling arm curve  $m_{Mo}$

Diplomski rad IKAS 105

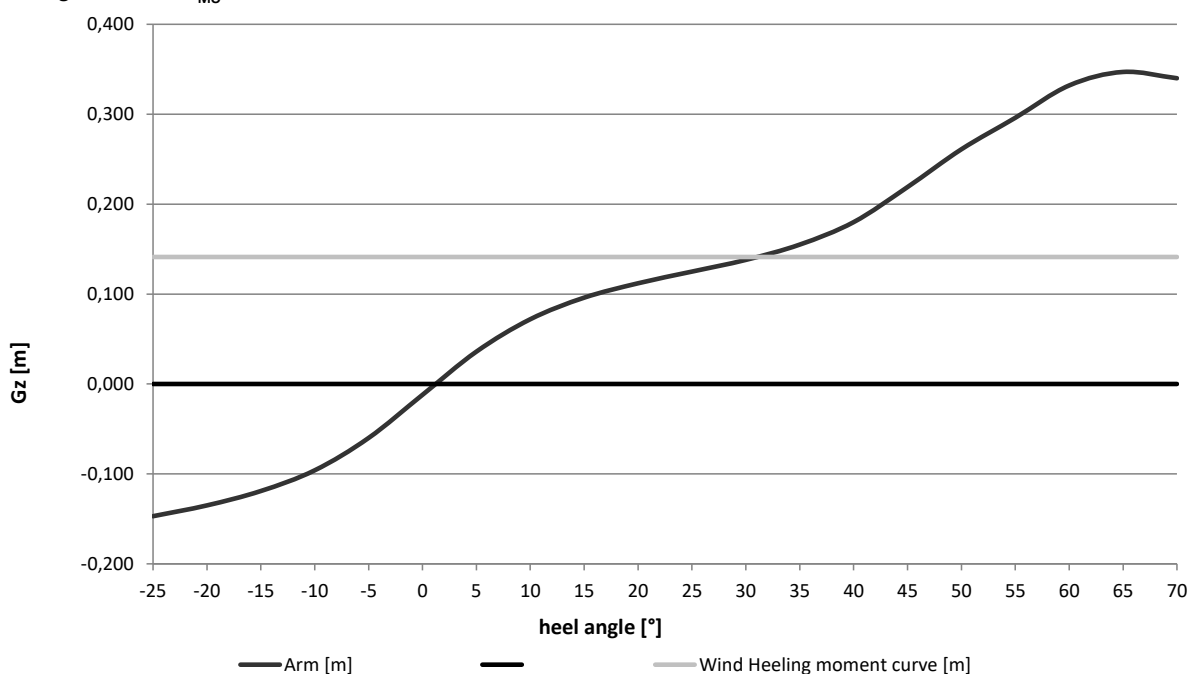

ISO 12217-1:2017 CALCULATION WORKSHEET No.7

HEEL DUE TO WIND ACTION

Diplomski rad IKAS 105

**NB: This sheet is to be completed for both Minimum Operating and Loaded arrival condition**

Initial check:

Design Categories C and D only

Item	Symbol	Unit	m <sub>LA</sub>	m <sub>MO</sub>	Ref.
Windage area (NOT subject to minimum of 0.5 L <sub>H</sub> B <sub>H</sub> )	A <sub>LV</sub>	m <sup>2</sup>		14,92	3.3.7
Length of Hull	L <sub>H</sub>	m	10,50	10,50	3.3.2
Beam of hull	B <sub>H</sub>	m	3,20		3.3.3
Ratio A <sub>LV</sub> /(L <sub>H</sub> B <sub>H</sub> ) at m <sub>MO</sub>		-----	0,44		
Is ratio A <sub>LV</sub> /(L <sub>H</sub> B <sub>H</sub> ) equal to or greater than 0.5?			No		6.4
If answer is NO, no other assessment is required.					

Calculation of wind heeling moment:

Item	Symbol	Unit	m <sub>LA</sub>	m <sub>MO</sub>	Ref.
Length of waterline	L <sub>WL</sub>	m			3.3.2
Draught at the mid-point of L <sub>WL</sub>	T <sub>M</sub>	m			6.3.2
Lever between centroids of above and below water areas	h	m			6.3.2
Calculation wind speed	v <sub>W</sub>	m/s	n.a.		3.5.1
Wind heeling moment M <sub>W1</sub> = 0.53 A <sub>LV</sub> h v <sub>W</sub> <sup>2</sup>	M <sub>W</sub>	Nm	#VALUE!	#VALUE!	6.4.2
Wind heeling moment M <sub>W2</sub> = 0.3 A <sub>LV</sub> (A <sub>LV</sub> / L <sub>WL</sub> + T <sub>M</sub> ) v <sub>W</sub> <sup>2</sup>	M <sub>W</sub>	Nm	#DIV/0!	#DIV/0!	6.4.2

Angle of heel due to wind:

Item	Symbol	Unit	m <sub>LA</sub>	m <sub>MO</sub>	Ref.
FROM RIGHTING MOMENT CURVE: angle of heel due to wind	φ <sub>W</sub>	degrees	12,55	30,95	6.4.3
OR ALTERNATIVELY: wind heeling moment M <sub>W</sub> divided by 9.806	M <sub>W</sub>	kg.m	#VALUE!	#VALUE!	
Angle of heel due to wind when moment above applied	φ <sub>W</sub>	degrees			6.4.3
Maximum permitted angle of heel during offset load test (from worksheet 5b)	φ <sub>O(R)</sub>	degrees	16,23		6.2.3
Downflooding angle	φ <sub>DA</sub>	degrees	50	48	3.2.2
Maximum permitted angle of heel due to wind = lesser of 0.7φ <sub>O(R)</sub> and 0.7φ <sub>DA</sub>		degrees	11,4	11,4	6-4.3
Is angle of heel due to wind less than permitted value?			Fail	Fail	6.4.3
<b>Design Category possible on wind heeling =</b>					

**ISO 12217-1:2017 CALCULATION WORKSHEET No. 8**

Diplomski rad IKAS 105

**NB: This sheet is to be completed for the Loaded Arrival Condition.**

**calculation required**

Please submit multiple copies of this page if applicable

		Recess	Ref.
<b>Further exemptions according to 6.5.1</b>			
Angle of vanishing stability > 90° ?	YES/NO	Yes	6.5.1a)
Over at least 35% of the periphery is the depth of the recess less than 3% of the max. breadth of the recess (e.g. toe rails, low bulwarks)	YES/NO		6.5.1b)
At least 5% of the bulwark area positioned within the lowest 25% of the bulwark height drains overboard and the bulwark height is less than 12,5% of the maximum breadth of the recess <i>(attention, req. 1) and 2) below must get also a "Yes" to fulfill all requirements)</i>	YES/NO		6.5.1c)
Unobstructed drainage area from the recess on each side of the boat centreline	m <sup>2</sup>		6.5.1d)
Volume of the recess to the recess retention level	m <sup>3</sup>		
Drainage area per side (m <sup>2</sup> ) divided by recess volume (m <sup>3</sup> )			6.5.1d)
Height position of drainage area (lowest 25% / lowest 50% / full depth)			6.5.1d)
Requirements of 6.5.1.d) fulfilled? <i>(attention, req. 1) and 2) below must get also a "Yes"</i>	YES/NO		6.5.1d)
1) the lower edge of the drainage openings are not more than 10 mm above recess sole height for at least 70 % of the width of each opening?	YES/NO	Yes	6.5.1 c) & d)
2) If drainage area is provided by an open or partially open transom, are the openings extend to the outboard sides of the recess sole on both sides?	YES/NO	Yes	6.5.1 c) & d)

Is recess exempt from size limit? If "yes", no further calculation required.	<b>Yes</b>	6.5.1
--	------------	-------

**Calculation methods:**

Item	Symbol	Unit	Value	Ref.
			Recess	
<b>SIMPLIFIED METHOD:</b> Use 1), 2) or 3) below.				
Average freeboard to loaded waterline at aft end of recess	$F_A$	m		6.5.2.1
Average freeboard to loaded waterline at sides of recess	$F_S$	m		6.5.2.1
Average freeboard to loaded waterline at forward end of recess	$F_F$	m		6.5.2.1
Waterline length at mLA	$L_{WL}$	m		
Waterline breadth at mLA (for multihulls insert max. beam waterline $B_{WLmax}$ acc. to ISO 8666)	$B_{WL}/B_{WLmax}$	m		ISO 8666 4.3.4/5
Maximum length of recess at the retention level (see 3.5.11)	$l$	m		6.5.2.4
Maximum breadth of recess at the retention level (see 3.5.11)	$b$	m		6.5.2.4

*- In case of asymmetric recesses (e.g. bowrider, centercockpits, ...), please insert length and breadth of each area below; this allows a more exact calculation using simplified method 1) or 2)*

	max. length	max. breadth	Unit	% loss GMT (option 1)	% loss GMT (option 2)	Ref.
Maximum length and breadth of recess part A			m			6.5.2.2/3
Maximum length and breadth of recess part B			m			6.5.2.2/3
Maximum length and breadth of recess part C			m			6.5.2.2/3
Maximum length and breadth of recess part D			m			6.5.2.2/3
Maximum length and breadth of recess part E			m			6.5.2.2/3
Maximum length and breadth of recess part F			m			6.5.2.2/3
Maximum length and breadth of recess part G			m			6.5.2.2/3
Maximum length and breadth of recess part H			m			6.5.2.2/3
Maximum length and breadth of recess part I			m			6.5.2.2/3

to be continued on page 2

**ISO 12217-1:2017 CALCULATION WORKSHEET No. 8**

page 2

	Symbol	Unit	Value	Ref.
			Recess	
Average freeboard to recess periphery $= (F_A + 2F_S + F_F) / 4$	$F_R$	m	0	6.5.2.1
Category A permitted percentage loss in metacentric height $(GM_T) = 250 F_R / L_H$			n.a.	6.5.2.1
Category B permitted percentage loss in metacentric height $(GM_T) = 550 F_R / L_H$			0	6.5.2.1
Category C permitted percentage loss in metacentric height $(GM_T) = 1\,200 F_R / L_H$			n.a.	6.5.2.1

SIMPLIFIED METHOD: Use 1), 2) or 3) below.				Recess	
<b>1) Loss of <math>GM_T</math> used?</b>					6.5.2.1
Second moment of area of free-surface of recess	$SMA_{RECESS}$	$m^4$	0		6.5.2.2
Metacentric height of boat at $m_{LA}$	$GM_T$	m			6.5.2.2
Calculated percentage loss in metacentric height	$(GM_T) = \frac{102\,500 \times SMA_{RECESS}}{m_{LA} \times GM_T}$				6.5.2.2
<b>2) Second moment of areas used?</b>					6.5.2.1
Second moment of area of free-surface of recess	$SMA_{RECESS}$	$m^4$	0		6.5.2.3
Second moment of area of waterplane of boat at $m_{LA}$	$SMA_{WP}$	$m^4$	0		6.5.2.3
Calculated percentage loss in metacentric height	$(GM_T) = \left( \frac{245 \times SMA_{RECESS}}{SMA_{WP}} \right)$				6.5.2.3
<b>3) Recess dimensions used?</b>					6.5.2.1*
Maximum length of recess at the retention level (see 3.5.11)	$l$	m	0		6.5.2.4
Maximum breadth of recess at the retention level (see 3.5.11)	$b$	m	0		6.5.2.4
Calculated percentage loss in metacentric height	$(GM_T) = 270 \left( \frac{l \times b^3}{L_H \times B_H^3} \right)^{0.7}$				6.5.2.4

<b>Requirement:</b> from results above, applied design category possible?	<b>Fail</b>	6.5.2.1
---	-------------	---------

DIRECT CALCULATION METHOD used?					6.5.3
Percentage full of water = $60 - 240 F/L_H$					6.5.3a)
Wind heeling moment for intended design category	$M_W$	N·m	4005,19728		6.5.3b)
Crew heeling moment at $\phi_{GZmax}$		N·m			6.5.3c)
Maximum swamped righting moment up to least of $\phi_D$ , $\phi_V$ or $50^\circ$		N·m			6.5.3d)
Required margin of righting moment over heeling moment		N·m	4690,75		6.5.3d)
Actual margin of righting moment over heeling moment		N·m			6.5.3d)

<b>Applied design category possible?</b>	<b>n.a.</b>	
--	-------------	--

Design category C boats using option 6					
Recess entirely contained within LH/2 of the bow ?					6.5.4
Volume to retention level (see 3.5.9) larger than $(L_H B_H F_M) / 40$ ?					6.5.4
If both questions are answered with 'yes' check requirements below:					
Recess is quickdraining recess either overboard or in the bilge?					6.5.4
Design category possible				<b>n.a.</b>	6.5.4

**ISO 12217-1:2017 CALCULATION WORKSHEET No. 9 Habitable Multihulls & Motor Sailers**

Diplomski rad IKAS 105

**Habitable Multihulls** Is boat habitable multihull acc. to cl. 3.1.8 ?

**NB: Boats complying with the other requirements of this standard for design categories A, B or D are not considered to be susceptible to inversion**

**Boats of design category C:**

Item	Symbol	Unit	Value	Ref.
Beam of hull	$B_H$	m	3,20	3.3.3
Volume of displacement in minimum operation condition	$V_D$	m <sup>3</sup>	3,74	3.4.7
Cube root of volume of displacement in $m_{MO}$	$V_D^{1/3}$	m	1,55	
Height of centroid of $A_{LV}$ above $m_{MO}$ waterline	$h_C$	m		6.6.3
Actual value of $h_C / B_H$	$h_C / B_H$	/		
Boat considered to be susceptible to inversion if either (10) or (11)				6.6.3
(10) when $V_D^{1/3} > 2,6$ and $h_C / B_H > 0,572$			n.a.	6.6.3
(11) when $V_D^{1/3} \leq 2,6$ and $h_C / B_H > 0,22 V_D^{1/3}$				6.6.3
<b>Is boat susceptible to inversion in design category C?</b>			No	
If 'Yes', boat must comply with ISO 12217-2, cl. 7.12 and cl. 7.13 (relevant ISO 12217-2 worksheets to be used)				6.6.1
Boat complies with ISO 12217-2, cl. 7.12 buoyancy when inverted?		Yes / No		6.6.1a)
Boat complies with ISO 12217-2, cl. 7.13 escape after inversion?		Yes / No		6.6.1b)

**Motor Sailer** Is boat defined as "non-sailing" ?   
 Is boat fitted with mast and sails?

**NB: Only applicable to non-sailing boats with sails of design cat A or B**

Item	Symbol	Unit	Value	Ref.
Sum of the windage area as defined in 3.3.7 plus the actual profile area, including overlaps, of the largest sail plan suitable for windward sailing in true winds of more than 10 kn to 12 kn (5,1 m/s to 6,2 m/s) and supplied or recommended by the builder as standard;	$A_{max}$	m <sup>2</sup>		6.7.2
Vertical distance between the geometric centres of $A_{max}$ and underwater profile area	$h$	m		6.7.2
Wind speed, 18 m/s for category A and 14 m/s for category B	$v_W$	m/s	14,00	6.7.2
Heeling moment due to wind ( $M_W = 0,53 A_{max} h v_W^2$ )	$M_W$	Nm	0	6.7.2
Maximum righting moment of the boat in $m_{LA}$ up to $\Phi_{DA}$	$RM_{max1}$	Nm	12.419	3.5.11
<b>Wind heeling moment <math>M_W</math> less than 50% of <math>RM_{max1}</math> ?</b>			Pass	6.7.2

**ISO 12217-1:2017 CALCULATION WORKSHEET No.10 FLOTATION TEST**

Diplomski rad IKAS 105

**Annexes E and F**

**assumed Crew Limit (CL) =** 10

*theoretical calculation method used, calculation attached?*

**Preparation**

Item	Unit	Response	Ref.
Mass equal to 25% of dry stores and equipment added?			F.2 a)
Inboard or outboard engine fitted?			
If inboard fitted, correct engine replacement mass fitted?			F.2 d)
Assumed outboard engine power?	Kw	460	F.2 c)
Mass fitted to represent outboard engine, controls, and battery.	kg	558	Tables F.1 and F.2
Portable fuel tanks removed and/or fixed tanks are filled?			F.2 f)
Cockpit drains open and drain plugs are fitted?			F.2 g)
Void compartments which are not air tanks are opened?			F.2 i)
Number of integral air tanks required to be open?			Table F.3
Type of test weights used: lead, 65/35 brass, steel, cast iron, aluminum			F.3.2
Material factor <i>d</i>		Failure	Table F.4

**Swamped stability test:**

Item	Unit	Response	Ref.
Dry mass of test weights = $6dCL$ but $\geq 15d$	kg	#VALUE!	Table F.6
Test weight hung from gunwale each of four positions in turn?			F.3.1
5 min after swamping, boat heels less than $45^{\circ}$			F.3.4 + F.3.5

**Swamped buoyancy test:**

Item	Unit	Response	Ref.
<b>Load test:</b>			F.4
Design Category assessed		B	
Dry mass of test weights used	kg	#VALUE!	Table F.5
5 min after swamping, boat floats approximately level with more than 2/3 of periphery above water?			F.4.3

**Swamped buoyancy test (for design cat B only)**

Item	Unit	Response	Ref.
Total buoyant volume according to Iso 6185-4:2011, clause 7.6.1 and 7.6.2	m <sup>3</sup>		F.4.4; ISO 6184-4
$1,33 m_{LDC} / 1000$	t	6,911345	3.4.5
Total buoyant volume > $1,33 m_{LDC} / 1000$ ?		n.a.	F.4.4

**Flotation material and elements:**

Item	Response	Ref.
All flotation elements comply with all requirements?		Table G.1

<b>Design Category given:</b> NB: boat must obtain PASS in all above tables	<b>Fail</b>
---	-------------

**ISO 12217-1:2017 CALCULATION WORKSHEET No. 11 DETECTION + REMOVAL OF WATER**

Diplomski rad IKAS 105

Item	response	Ref.
The internal arrangement facilitates the drainage of water to bilge suction point(s), to a location from which it can be bailed rapidly, or directly overboard?	Yes	6.9.1
Is boat provided with a means of removing water from the bilges in accordance with 15083?	Yes	6.9.2
Table 2 option used for assessment:	2	6.9.3; 5.4 table 2
Can water in boat be detected from helm position?		6.9.3
Methods used: direct visual inspection		6.9.3
transparent inspection panels		6.9.3
bilge alarms		6.9.3
indication of the operation of automatic bilge pumps		6.9.3
other means (specify):		6.9.3

ISO 12217-1:2017 en220801

CALCULATION WORKSHEET No.12

SUMMARY

Design Description:	Diplomski rad IKAS 105		
Design Category intended:	B	Crew Limit:	10
Date:	2023-09-14		

Sheet	Item	Symbol	Unit	Value		
	<b>Length of hull:</b> (as in ISO 8666)	$L_H$	m	10,50		
	<b>Length of waterline in loaded arrival condition</b>	$L_{WL}$	m	9,06		
	<b>Beam of hull:</b> (as in ISO 8666)	$B_H$	m	3,20		
	<b>Masses:</b>					
1	Empty craft mass	$m_{EC}$	kg	1831		
	Maximum load	$m_L$	kg	1561		
	Maximum load for the builder's plate acc. to ISO 14945:2021	$m_{MBP}$	kg	1000		
	Number of portable tanks included in builder's plate weight			0		
	Light craft condition mass	$m_{LC}$	kg	3636		
	Maximum Loaded condition mass = $m_{LC} + m_{ML}$	$m_{LDC}$	kg	5197		
	Loaded arrival condition mass	$m_{LA}$	kg	4691		
	Minimum operating condition mass	$m_{MO}$	kg	3836		
1	<b>Is boat sail or non-sail?</b>	SAIL/NON-SAIL		NON-SAIL		
2	<b>Option selected:</b>			2		
3	<b>Downflooding openings:</b>	Are all requirements met?		Pass		
		Watertightness test for closing appliances done successful?		Pass		
		Exemptions ok or openings considered as possible downflooding openings?		n.a.		
3	<b>Downflooding angle:</b> (Categories A and B only)	degrees	Required	$m_{MO}$	$m_{LA}$	Pass/Fail
		degrees	> 25	48	50	Pass
3 & 4	<b>Downflooding height:</b> Worksheet employed for basic height	exempted acc. to 6.1.2.1?		0		
	basic requirement	m	0,62	1,56	Pass	
	reduced height for small openings (only using figures)	m	0,46	1,56	Pass	
	reduced height at outboard (options 3, 4, 6 only)	m	n.a.	1,56	n.a.	
	increased height at bow (options 3, 4, 6 only)	m	n.a.	1,56	n.a.	
5	<b>Off-set load test:</b>	Unit	Required	Actual	Pass/Fail	
	Testing for least stability: maximum heel angle	degrees	< 16,23	2,00	Pass	
	Testing for least freeboard: heeled freeboard margin	m	n.a.	0,16	n.a.	
	Maximum crew limit for stability			10		
	Maximum crew limit for freeboard			10		
6	<b>Resistance to waves and wind:</b> (options 1, 3) at $m_{LA}$ and $m_{MO}$					
	<b>Rolling in beam waves and wind:</b> ratio $A_2/A_1$	-	$\geq 1.0$	0,80	0,85	Fail
	Resistance to waves: value of $\sigma_{GZMax}$	degrees	---	65,00	65,00	
	value of $RM_{30}$ or $RM_{MAX}$	kNm	7	7,13	5,19	Fail
	value of $GZ_{30}$ or $GZ_{MAX}$	m	0,2	0,16	0,14	Fail



7	<b>Heel due to wind:</b> (options 2,4,5,6) at $m_{LA}$ and at $m_{MO}$					n.a.
	at $m_{MLA}$ : heel angle due to wind	degrees	<		12,55	n.a.
	if required at $m_{MO}$ : heel angle due to wind	degrees	<	30,95		n.a.
8	<b>Recess size:</b> (options 1 and 2 except category D)					
	Simplified method: max reduction in $GM_T$	%	≤	0		n.a.
	Direct calculation: margin righting moment over heeling moment	N m	≥	4690,75		n.a.
	For category C boats using option 6; drainage requirements for recesses entirely contained within LH/2 of the bow are fulfilled?					n.a.
9	<b>Habitable Multihulls:</b> Is Category C boat vulnerable to inversion?			Yes / No		
	Complies with Part 2 clause 7.12 for inverted buoyancy?			Pass / Fail		
	Complies with Part 2 clause 7.13 for means of escape?			Pass / Fail		
9	<b>Motor Sailers</b> Complies with requirement for excess of $RM_{MAX}$ over $M_W$ ?			Pass / Fail		
10	<b>Flotation test:</b> (options 3 and 4 only) All preparations completed?			Yes / No		n.a.
	<b>Swamped stability:</b> 5 min after swamping, does boat heel less than 45°?			Pass / Fail		n.a.
	<b>Load test:</b> 5 min after swamping, does boat float level with 2/3 periphery showing?			Pass / Fail		n.a.
	<b>Swamped buoyancy,</b> for boats using option 3: Total buoyant volume > 1,33 $m_{LDC} / 1000$ ?			Pass / Fail		n.a.
	<b>Flotation elements:</b> do all elements comply with all the requirements?			Pass / Fail		n.a.
11	<b>Detection &amp; removal of water</b> are all requirements satisfied?			Yes / No		Yes
<b>NB:</b> Boat must pass all requirements applicable to selected option to be given intended Design Category.						
<b>Design Category given:</b>	<b>B</b>	Assessed by:	<b>Ivan Kašikić</b>			

Documentation of downflooding opening / closing appliance (photo/drawing) attached?

If applicable, cockpit calculation according to ISO 11812 attached ?

If applicable, curve of righting moments in  $m_{MO}$  and  $m_{LA}$  attached ?

Appropriate add. information attached (e.g. photos, drawings,...) ?

If applicable, ISO 12216 calculation attached?

Signature: \_\_\_\_\_

## ISO 12217-1:2017 NON-SAILING BOATS OF LENGTH GREATER THAN OR EQUAL TO 6m

Manufacturer:	Diplomski rad
Signatory, Name:	Ivan Kašikić
Signatory, Title:	Izvanbrodski pogonski sustav
Phone:	
Email:	
WWW:	
CIN Model Year:	
Model Name:	IKAS 105

*This calculation sheet is provided by IMCI "as is" and any express or implied warranties, including, but not limited to, the implied warranties of fitness for a particular purpose are disclaimed.*

blue cells are derived values

yellow cells require data input

Please make sure to set your signature on the summary! (worksheet 12)  
either digitally or print summary, sign and attach scan

- most worksheets have additional comments / remarks / other calculations beside the printout area; please take into account.

- For boats in category A and B either fill in worksheet 6c and 6d or attach curve of righting moments for both loading conditions to the documentation.

- For boats with quick-draining cockpit the cockpit calculation according to ISO 11812 shall be enclosed to the documentation.

- Please attach other detailed information as appropriate, e.g. photos, sketches etc. for sill height, openings, companion way doors, location of flooding points, practical tests etc.

- When entering data, please use the correct separator for your Excel version, many application problems are the result of incorrect separators ( , or . )

- Please send questions, found errors, typos, mistakes, ect. directly to ralf.dewender@imci.org or to the headoffice with info@imci.org; every comment helps us to provides you with a better version

- Please be aware that there is NO technical difference between the requirements of ISO 12217-1:2015 and EN ISO 12217-1:2017; change of the name is just because of the harmonisation process; for ISO 12217-1:2020 the main change is the exclusion of optional equipment and margin for future additions from the maximum load and the result of the "maximum recommended load for builder's plate" (with ISO 14945:2021 and ISO 14946:2021 renamed to "maximum load for the builder's plate,  $m_{MBP}$ ") which exludes OB engine weights and the optional equipment.

**ISO 12217-1:2017 NON-SAILING BOATS OF LENGTH GREATER THAN OR EQUAL TO 6m  
CALCULATION WORKSHEET No. 1**

ISO 12217-1:2017 en220801

Diplomski rad IKAS 105

Design Category intended:	C	Monohull / Multihull:	Monohull	Propul.Type:	OB
Item	Symbol	Unit	Value	Ref.	
Length of hull as in ISO 8666	$L_H$	m	10,50		3.3.1
Length of waterline in loaded arrival condition	$L_{WL}$	m	9,06		3.3.2
<u>Empty Craft condition mass</u>	$m_{EC}$	kg	1831,0		3.4.1
standard equipment (incl. OB engine(s) and ess. safety equipment)		kg	1805,0		3.5.12
water ballast in tanks which are notified in the owner's manual to be filled when the boat is afloat		kg	0,0		3.4.2
Light craft condition mass	$m_{LC}$	kg	3636,0		3.4.2
<b>Mass of:</b>					
Desired crew limit	CL	----	10		3.5.3
Mass of:					
desired crew limit at 75 kg each		kg	750,0		
provisions + personal effects		kg	250,0		3.4.4
drinking water		kg	28,5		3.4.4
fuel		kg	304,0		3.4.4
lubricating and hydraulic oils		kg	19,0		3.4.4
black water		kg	47,5		3.4.4
grey water		kg	133,0		3.4.4
water ballast		kg	0,0		3.4.4
other fluids carried aboard		kg	28,5		3.4.4
stores, spare gear and cargo (if any)		kg	0,0		3.4.4
inflatable life raft(s) in excess of essential safety equipment		kg	0,0		3.4.4
other small boats carried aboard		kg	0,0		3.4.4
Maximum load = sum of above masses <b>using ISO ISO 12217-1:2020</b>	$m_L$	kg	1560,5		3.4.4
optional equipment and fittings not included in basic outfit		kg	0,0		3.4.4 / 3.4.5
Maximum load = sum of above masses <b>using ISO 12217-1:2017</b>	$m_L$	kg	1560,5		3.4.4
<u>Maximum Load condition mass</u>	$m_{LDC}$	kg	5196,5		3.4.5
Mass to be removed for loaded arrival condition		kg	505,8		3.4.6
<u>Loaded Arrival condition mass</u>	$m_{LA}$	kg	4690,8		3.4.6
Mass of:					
minimum number of crew weight according to 3.4.3		kg	150,0		3.4.3a)
non-consumable stores and equipment normally aboard		kg	50,0		3.4.3b)
inflatable life raft		kg			3.4.3
Load to be included in Minimum Operating Condition	$m'_L$	kg	200,0		3.4.3
<u>Light craft condition mass</u>	$m_{LC}$	kg	3636,0		3.4.2
Mass in the Minimum Operating Condition	$m_{MO}$	kg	3836,0		3.4.3
<u>Maximum load for the builder's plate using EN ISO 14946:2021 and EN ISO 14945:2021 (if manually reduced on Worksheet 1b the reduced value is shown)</u>	$m_{MBP}$	kg	1000,0		
<b>Is boat sail or non-sail?</b> Nominal sail area	$A_S^*$	m <sup>2</sup>	0,0		3.3.8
Sail area / displacement ratio = $A_S / (m_{LDC})^{2/3}$		----	0,0000		3.1.2
CLASSIFIED AS [non-sail if $A_S / (m_{LDC})^{2/3} < 0.07$ ]	SAIL/NON-SAIL ?		<b>NON-SAIL</b>		3.1.2
NB If NON_SAIL, continue using these worksheets, if SAIL, use ISO 12217-2					

## ISO 12217-1:2017 / ISO 14945:2021 CALCULATION WORKSHEET No.1b Builder's plate

Diplomski rad IKAS 105

Since 2021-12-09 EN ISO 14945:2021 and EN ISO 14946:2021 are harmonised!

The formerly 'Maximum recommended load for builder's plate' became '**Maximum load for the builder's plate**',  $m_{MBP}$ .

$m_{MBP}$  does not include the optional equipment anymore; also the weight of outboard engines is excluded from  $m_{MBP}$  and can be shown in a separated line on the plate.

Below you find two examples for the builder's plates with the maximum value for  $m_{MBP}$  calculated from the stability calculation on worksheet 1; one for craft powered by outboard engines, one for craft powered by inboard or sterndrive engines.

For portable tanks, please change the default 'yes' on the right side in 'no, portable tank'; the weight of the tank will be included in  $m_{MBP}$ .

Please be aware that ISO 14946:2021 allows in clause 6 that the maximum recommended load can be downrated or limited by the manufacturer at any time. Therefore you find an extra cell to enter a manual reduced value for the maximum load for the builder's plate.

Default outboard engine mass is calculated with the help of table F.1 from EN ISO 12217-1:2017; nevertheless the manufacturer can insert the actual engine mass the boat model is calculated with.

This is strongly recommended for engines with more than 164,2 kW which are outside the table range (means all 300, 350, 400, 450 and more HP outboard engines) !

Please be also aware that the design of these plates is just a proposal from EN ISO 14945, the manufacturer is free to change the design as long all requirements of the standard are fulfilled.

Item	Value	Unit	Ref.
Manually reduced value for the 'Maximum load for the builder's plate' $m_{MBP}$	1000	kg	EN ISO 14945, cl. 6, note 2
Maximum engine power of a single engine	230	kW	
Maximum number of engines	2		
Actual value of the max. outboard engine mass, (sum of all engines) as defined by the manufacturer and used for stability calculation (default value is table F.1 from ISO 12217-1:2017 value)	558	kg	EN ISO 12217-1:2017 table F.1

Please see builder's plate example with values calculated from worksheet 1 entries on next page:

Builder's plate information for craft powered by outboard engines -- Example

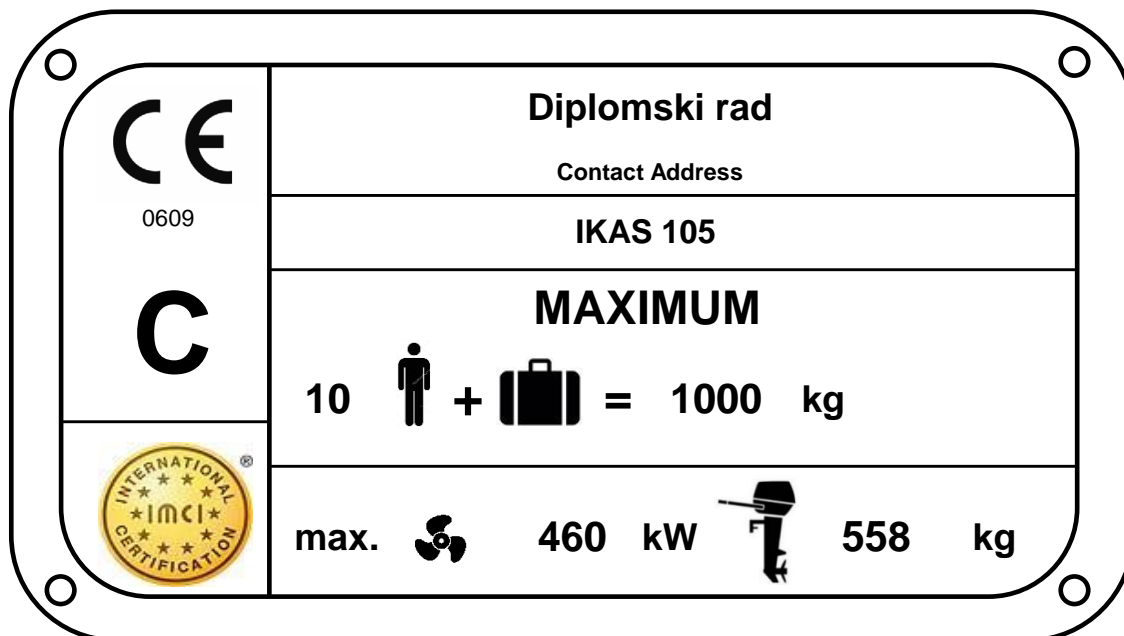

Builder's plate information for craft powered by inboard or sterndrive engines

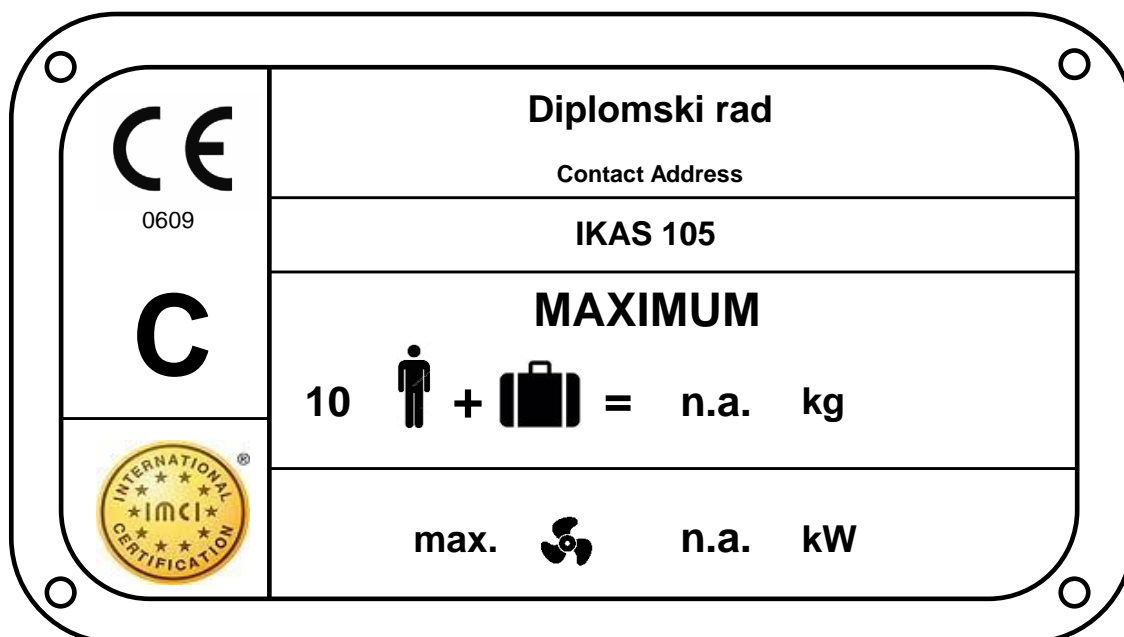

## ISO 12217-1:2017 CALCULATION WORKSHEET No.2 TESTS TO BE APPLIED

Diplomski rad IKAS 105

Question	Answer	Ref.
Is boat fully enclosed? (see definition in ref.) YES/NO?	Yes	3.1.6
Is boat partially protected? (see definition in ref.) YES/NO?	No	3.1.7

Item	Symbol	Unit	Value	Ref.
Windage area in minimum operating condition	$A_{LV}$	$m^2$	14,92	3.3.7
Length of Hull	$L_H$	m	10,50	3.3.2
Beam of hull	$B_H$	m	3,20	3.3.3
Freeboard at midships	$F_M$	m	1,48	3.3.5
Ratio $A_{LV}/(L_H B_H)$		---	0,44	

Choose any ONE of the following options and use all the worksheets indicated for that option.

Option	1	2	3	4	5	6
Categories possible	A and B	C and D	B	C and D	C and D	C and D
Decking or covering	fully enclosed	fully enclosed	any amount	any amount	partially protected	any amount
Downflooding openings	3	3	3	3	3	3
downflooding angle	3		3			
Downflooding height test	All boats	3	3	$3^a$	3	3
	Annex A method	4	4	$4^a$	4	4
Offset load test	5	5	5	5	5	5
Resistance to waves + wind	6		6			
Heel due to wind action		$7^b$		$7^b$	$7^b$	$7^b$
Recess size	8	$8^c$				$8^c$
Habitable multihulls	9	9	9	9	9	9
Motor sailers	9	9	9	9	9	9
Flotation test			10	10		
Flotation material			10	10		
Detection and removal of water	11	11	11	11	11	11
SUMMARY	12	12	12	12	12	12

a. The downflooding height test is not required to be conducted on the following Category C and D boats:

I. those which, when tested in accordance with normative annex F.4, have been shown to support, in addition to the mass required by F.2 and Table F.5, an additional equivalent dry mass (kg) of  $(75 \cdot CL + 10\%$  of dry weight of stores and equipment included in the maximum total load), or  
 II. those boats that do not take on water when heeled to  $90^\circ$  from the upright in the light craft condition.

b. The application of Worksheet 7 is only required for boats where  $A_{LV}/(L_H B_H) > 0,5$ .

c. Only required for boats of design category C; for option 6 clause 6.5.4 only

Option selected

2

**ISO 12217-1:2017 CALCULATION WORKSHEET No. 3 DOWNFLOODING**

Diplomski rad IKAS 105

**Downflooding Openings:**

Question	Answer	Ref.
Have all appropriate downflooding openings been identified?	Yes	3.2.1
Have potential downflooding openings within the boat been identified?	Yes	6.1.1.4
Do all closing appliances satisfy ISO 12216?	Yes	6.1.1.1
Hatches or opening type appliances are not fitted below minimum height above waterline? *	Yes	6.1.1.2
Seacocks comply with requirements?	Yes	6.1.1.3
Are all openings on design category A or B boats fitted with closing appliances? **	Yes	6.1.1.5
<b>Categories possible:</b> A or B if all are YES, C or D if first five are YES	<b>A</b>	6.1.1

\* Except for emergency escape hatches on design category C boats, where 0,1 m is allowable \*\* Except openings for ventilation and engine combustion

**Exemptions Downflooding Openings:**

Question	Answer	Ref.
Drains from quick-draining recesses or watertight recesses acc. to cl. 6.1.1.6 b) are either:		
1) freeing ports with non-return flaps which are watertight from the exterior (degree 3) <b>or</b>		6.1.1.6 b)
2) have a drainage area smaller than three times the minimum area required of ISO 11812		6.1.1.6 b)
		6.1.1.6 b)
Opening appliances (e.g. side doors) in the topsides which comply with ISO 12216 are		
1) referenced in the owner's manual as watertight closure to be kept shut when under way, <b>and</b>		6.1.1.6 d)
2) marked inboard with "KEEP SHUT WHEN ..." in upper case letters not less than 4,8 mm high, <b>and</b>		6.1.1.6 d)
3) the height above waterline of the lowest part is > 50% of required downflooding height		6.1.1.6 d)
		6.1.1.6 d)
All other exemptions of cl. 6.1.1.6 checked and requirements fulfilled?		6.1.1.6
		6.1.1.6

**Downflooding angle (required for cat A & B only\*):**

Item	Symbol	Unit	Value	Ref.
required Category A = larger of $(\phi_O + 25)^\circ$ or $30^\circ$	$\phi_{D(R)}$	degrees	n.a.	6.1.3; Table 3
( $\phi_O$ = angle from offset load test)				
required Category B = larger of $(\phi_O + 15)^\circ$ or $25^\circ$	$\phi_{D(R)}$	degrees	n.a.	6.1.3; Table 3
Area of openings permitted to be submerged = $1.2 L_H B_H F_M$		cm <sup>2</sup>	<b>59,67</b>	6.1.3
<u>Actual downflooding angle:</u> at mass = $m_{MO}$	$\phi_{DA}$	degrees	<b>48</b>	6.1.3
at mass = $m_{LA}$	$\phi_{DA}$	degrees	<b>50</b>	6.1.3
Method used to determine $\phi_D$ :				Annex C
Design category possible on Downflooding Angle:			<b>n.a.</b>	6.1.3

**Downflooding Height: (all exempt exempt boats)**

Requirement		Basic requirement	Reduced value for small openings	Reduced value at outboard	Increased value at bow	
Is boat exempted from downflooding height requirements according to 6.1.2.1?		Yes / No				
Applicable to		all options	all options (using figures)	options 3, 4 or 6	options 3, 4, 6	
ref.		6.1.2.2 a)	6.1.2.2 d)	6.1.2.2 c)	6.1.2.2 b)	
obtained from Figs. 3 + 4 or annex A?		<b>fig 3 &amp; 4</b>	= basic x 0.75	= basic x 0.80	= basic x 1.15	
Maximum area of small openings ( $50L_H^2$ ) (mm <sup>2</sup> ) =			5513	///////	///////	
Required downflooding height $h_{D(R)}$	Fig. 3/ann. A	Category A	<b>0,62</b>	<b>0,46</b>	<b>0,49</b>	<b>0,71</b>
	Fig. 3/ann. A	Category B	<b>0,62</b>	<b>0,46</b>	<b>0,49</b>	<b>0,71</b>
	Fig. 3/ann. A	Category C	<b>0,62</b>	<b>0,46</b>	<b>0,49</b>	<b>0,71</b>
	Fig. 4/ann. A	Category D	<b>0,40</b>	<b>0,30</b>	<b>0,32</b>	<b>0,46</b>
<u>Actual Downflooding Height</u> $h_D$			<b>1,56</b>	<b>1,56</b>	<b>1,56</b>	<b>1,56</b>
Design Category possible		<b>C</b>	<b>C</b>			
Design Category possible on Downflooding Height = lowest of above					<b>C</b>	

## ISO 12217-1:2017 CALCULATION WORKSHEET No.3a DOWNFLOODING OPENINGS / CLOSING APPLIANCES

Diplomski rad IKAS 105

### General overview downflooding openings and closing appliances

**NOTE:** All drawings are not blocked by a password, so please replace with own drawings if at hand.

**NOTE:** See X, Y, Z coordinates for worksheet 3b as illustrated below

**Top View**

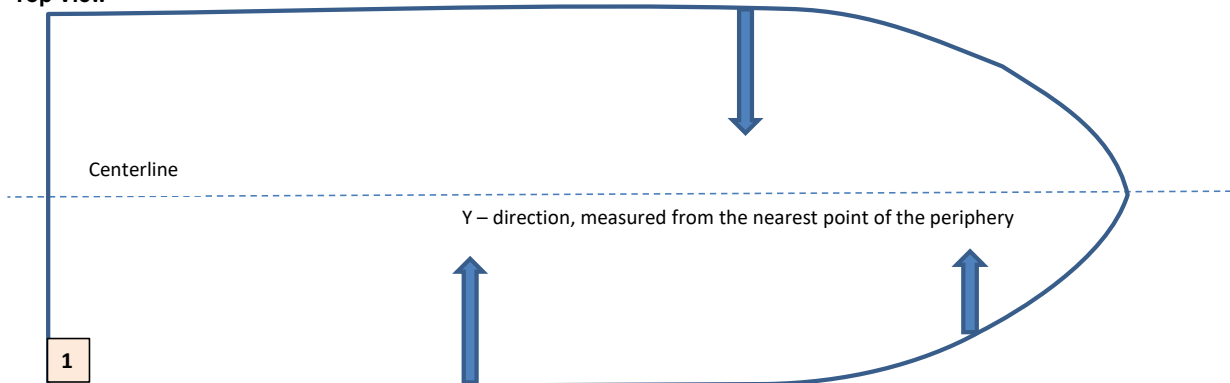

**Side View Starboard**

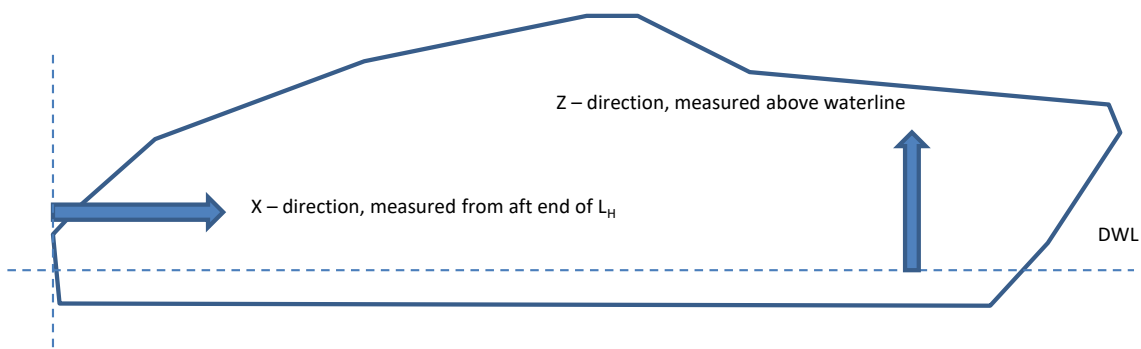

**Side View Port**

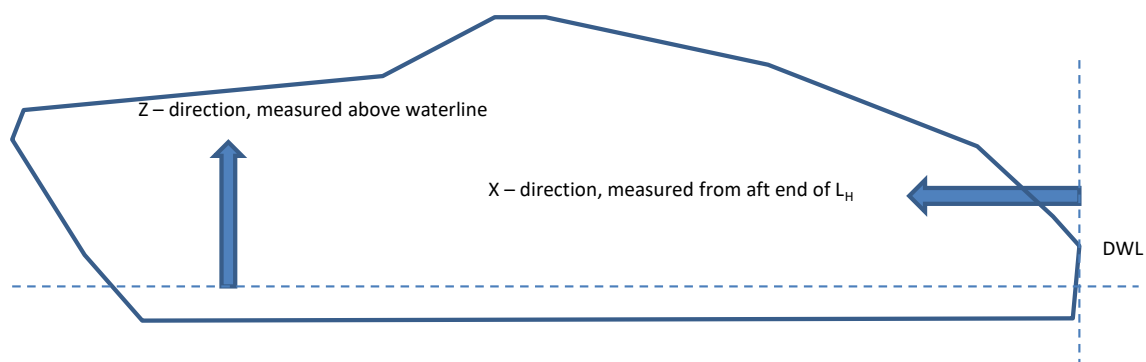

Please insert a short description and measurements of downflooding openings and closing appliances under the corresponding number on worksheet 3b



## ISO 12217-1:2017 CALCULATION WORKSHEET No.3b DOWNFLOODING OPENINGS

Diplomski rad IKAS 105

### General overview downflooding openings and closing appliances

**NOTE:** Please submit for every pre-fabricated closing appliance a declaration of conformity (DoC) of the product.  
Please submit for every non pre-fabricated closing appliance a calculation acc. to ISO 12216 (see IMCI template).  
For both a watertightness test must be done!

Description of the downflooding opening / closing appliance	Nr.	X <sup>(a)</sup> [m]	Y [m]	Z (=h <sub>D</sub> ) [m]	watertightness test done	opening type <sup>(b)</sup>
Razma	1	0,00	0,00	1,56	n.a.	downflooding opening
	2					
	3					
	4					
	5					
	6					
	7					
	8					
	9					
	10					
	11					
	12					
	13					
	14					
	15					
	16					
	17					
	18					
	19					
	20					
	21					
	22					

**(a)** Please be aware that X is measured from the aft end of L<sub>H</sub>.

In Annex A calculations x<sub>D</sub> is measured from the bow or stern, whichever is nearest

**(b)** opening types are: normal downflooding openings without any opening appliances; pre-fabricated opening appliances; non-pre-fabricated opening appliances and other devices

**ISO 12217-1:2017 CALCULATION WORKSHEET No.4 DOWNFLOODING HEIGHT**

Diplomski rad IKAS 105

**Calculation using annex A**

Item	Symbol	Unit	Opening 1	Opening 2	Opening 3	Opening 4
<b>Position of openings</b>						
Least longitudinal distance from bow/stern	$x_D$	m				
Least transvers distance from gunwale	$y_D$	m				
$F_1 = \text{greater of } (1 - x_D/L_H) \text{ or } (1 - y_D/B_H)$	$F_1$	----	1,00	1,00	1,00	1,00
<b>Size of openings:</b>						
Combined area of openings to top of any down-flooding opening	$a$	mm <sup>2</sup>				
Longitudinal distance of opening from tip of bow	$x'_D$	m				
Limiting value of $a = (30L_H)^2$		mm <sup>2</sup>	99225	99225	99225	99225
$\text{If } a \geq (30L_H)^2, F_2 = 1,0$ $\text{If } a < (30L_H)^2, F_2 = 1 + \frac{x'_D}{L_H} \left( \frac{\sqrt{a}}{75 L_H} - 0,4 \right)$	$F_2$	----	1,00	1,00	1,00	1,00
<b>Size of recesses:</b>						
Volume of recesses which are not self-draining in accordance with ISO 11812	$V_R$	m <sup>3</sup>				
Is opening not a recess? Is recess quickdraining? Is recess not quickdraining?						
$k = V_R/(L_H B_H F_M)$	$k$	----	0	0	0	0
If opening is not a recess, $F_3 = 1$						
If recess is quickdraining, $F_3 = 0.7$	$F_3$	----	1,20	1,20	1,20	1,20
If recess is not quick draining, $F_3 = (0.7 + k^{0.5})$						
<b>Displacement:</b>						
Loaded displacement volume (see 3.4.5)	$V_D$	m <sup>3</sup>	5,07			
$B = B_H$ for monohulls, $B_{WL}$ for multihulls	$B$	m	3,2			
$F_4 = [(10 V_D)/(L_H B^2)]^{1/3}$	$F_4$	----	0,78			
<b>Flotation:</b>						
For boats using option 3 or 4, $F_5 = 0.8$						
For all other boats, $F_5 = 1.0$	$F_5$	----	1			
<b>Required calculation height: = <math>F_1 F_2 F_3 F_4 F_5 L_H / 15</math></b>	$h_{D(R)}$	m	0,65	0,65	0,65	0,65
Required downflooding height with limits applied (see annex A, Table A.1)	Category A	$h_{D(R)}$				
	Category B	$h_{D(R)}$				
	Category C	$h_{D(R)}$	0,3	0,3	0,3	0,3
	Category D	$h_{D(R)}$				
<b>Measured Downflooding Height:</b>	$h_D$	m				
<b>Design Category possible:</b>						
<b>Lowest of above =</b>						<b>Fail</b>

ISO 12217-1:2017 CALCULATION WORKSHEET - No. 5a

OFFSET LOAD TEST

Diplomski rad IKAS 105

Mass of people used for test

Name	Ident.	Mass (kg)
Person 1	A	85
Person 2	B	85
Person 3	C	85
Person 4	D	85
Person 5	E	85
Person 6	F	85
Person 7	G	85
Person 8	H	85
Person 9	I	85
Person 10	J	85

downflooding opening obvious to the crew?  Yes

Crew Area

Areas included and access limitations (if any):

Area	P/S	Incl?	Persons limit
Main Cockpit			
Aft Cockpit			
Fwd Cockpit			
Salon			
Cabins			
Side Decks			
Fore Deck			

Offset Load Test

Name	Ident.	Mass (kg)
Person 11	K	
Person 12	L	
Person 13	N	
Person 14	M	
Person 15	O	
Person 16	P	
Person 17	Q	
Person 18	R	
Person 19	S	
Person 20	T	

average mass per person:   
 number of persons permitted (through offset load test)

Area	P/S	Incl?	Persons limit
Cuddy Top			
Coachroof Top			
Wheelhouse Top			
Fly Bridge			
Swim Platform			

**Sketch:** Indicate possible seating locations along the length of the side to be tested using numbers, so that these may later be used to record the positions that people actually occupy. Locations should not be closer than 0.5 m between centers, and not less than 0.2 m from outboard edge unless on sidedecks less than 0.4 m wide.

1) Note whether it is asymmetric by adding P (port) or S (starboard) to denote the larger side.

**ISO 12217-1:2017 CALCULATION WORKSHEET - No. 5b**
**OFFSET-LOAD TEST**

Diplomski rad IKAS 105

**Stability Test - Full Procedure**

Boat being tested for:		x	stability	x	downflooding			please mark	
$L_H$ (m)	Min. permitted freeboard margin (m) (see Table 5)		Max. permitted heel angle (°) $= 11,5 + \frac{(24 - LH)^3}{520}$		Intended crew limit (CL)	Intended design category	Mass Test weights per person (kg) (Cat D only)	Max. Mass of test weights (kg) (= 98 x CL)	
10,50	0,147		16,23		10	C		980	
Does boat have a list?		No		If "YES" to which side?					
Is crew area asymmetric?		Yes		If "YES" to which side?					
Is downflooding asymmetric?		No		If "YES" to which side?					
Boat tested:		to Port							

**Test Data:**

Mass ident.	Location		Mass (kg)	Total mass (kg)	Lever (m)	Moment (kg-m)	Heel angle (°) P/S	min. freeb'd (m)	
	area	fore & aft						fwd	aft
1			85	85	0,32	26,78			
2			85	170	0,13	11,05			
3			85	255	0,85	72,25			
4			85	340	0,82	69,70			
5			85	425	1,12	95,20			
6			85	510	0,82	69,70			
7			85	595	0,75	63,75			
8			85	680	0,75	63,75			
9			85	765	0,69	58,65			
10			85	850	0,69	58,65	2,00	0,16	0,16
11				850		0,00			
12				850		0,00			
13				850		0,00			
14				850		0,00			
15				850		0,00			
16				850		0,00			
17				850		0,00			
18				850		0,00			
19				850		0,00			
20				850		0,00			

total:	$\Sigma$	max. angle	min freeboard	
	589,48	2,00	0,16	0,16

Max. mass of people allowed per above:	850	hence CL =	10	at	85	kg / person
--	-----	------------	----	----	----	-------------

Design category given: C

Safety Signs Required:	Fig B1:	No	Fig B2:	No	Fig B3:	No
------------------------	---------	----	---------	----	---------	----

## ISO 12217-1:2017 CALCULATION WORKSHEET No. 5c Simplified procedure for OFFSET LOAD TEST

Diplomski rad IKAS 105

This method may only be applied by calculation; requirements must be fulfilled for both conditions LC1 and LC2

### Preparation (curves of moments in Nm)

Question	Answer	ref.
Mass and the centre-of-gravity of the boat calculated for conditions LC1 and LC2?		B.3.2.2
Curves of righting moments calculated according to annex E?		B.3.2.3
Crew heeling moment curve calculated with $961 CL (B_C/2 - 0,2) \cos \phi$ or where the crew area includes side decks less than 0,4m wide with $480 CL BC \cos \phi$ ?		B.3.2.4

### Test data:

item	symbol	unit	LC1	LC2	ref.
Maximum transverse distance between the outboard extremities of any part of the crew area	$B_C$	m			B.3.2.4 & B.3.1.7
Heel angle at the point of intersection between crew heeling moment curve and the curve of righting moment	$\phi_O$	degrees	0,00	0,00	B.3.2.5
Maximum permitted heel angle	$\phi_{O(R)}$	degrees	16,23		B.3.2.5
Value of downflooding angle	$\phi_{DA}$	degrees			B.3.2.5
Value of minimum freeboard margin at $\phi_O$	$h_F$	m			
Minimum required freeboard margin	$h_{F(R)}$	m	0,15		6.2.2 table 4
Max. righting moment up to $\phi_{DA}$		Nm	#VALUE!	#VALUE!	
Crew heeling moment at $\phi_O$		Nm	FALSE	FALSE	

### Requirements:

Question	Answer	ref.
Is $\phi_O < \phi_{O(R)}$	Fail	B.3.2.5
Is $h_F > h_{F(R)}$	Fail	B.3.2.5
Is the max. righting moment up to $\phi_{DA} >$ crew heeling moment at $\phi_O$ ?	#VALUE! #VALUE!	B.3.2.5
Offset load test passed, if all questions above are answered with 'yes' (or n.a.)	Pass/Fail #VALUE!	B.3.2.5

**ISO 12217-1:2017 CALCULATION WORKSHEET No. 5d curve of righting moment LC1**

Diplomski rad IKAS 105

insert curve of righting moment in 5° steps in one of following units:

**OFFSET LOAD TEST**

<input type="text" value="Nm"/>	<input type="text" value="kg m"/>	<input type="text" value="m"/>	<input type="text" value="mLC1"/>	<input type="text" value="5016,25"/>
chosen unit				
crew heeling moment curve (either normal or if side decks smaller 0,4m)				

heel angle [°]	insert righting arm / moment [Nm, kg m, m]	righting moment [Nm]	righting moment [kg m]	righting arm Gz [m]	crew heeling moment curve [N m]
0		#VALUE!	#VALUE!	error	FALSE
5		#VALUE!	#VALUE!	error	FALSE
10		#VALUE!	#VALUE!	error	FALSE
15		#VALUE!	#VALUE!	error	FALSE
20		#VALUE!	#VALUE!	error	FALSE
25		#VALUE!	#VALUE!	error	FALSE
30		#VALUE!	#VALUE!	error	FALSE
35		#VALUE!	#VALUE!	error	FALSE
40		#VALUE!	#VALUE!	error	FALSE
45		#VALUE!	#VALUE!	error	FALSE
50		#VALUE!	#VALUE!	error	FALSE

point of intersection of righting moment curve and crew heeling moment curve

$\Phi_c$
<input type="text"/>

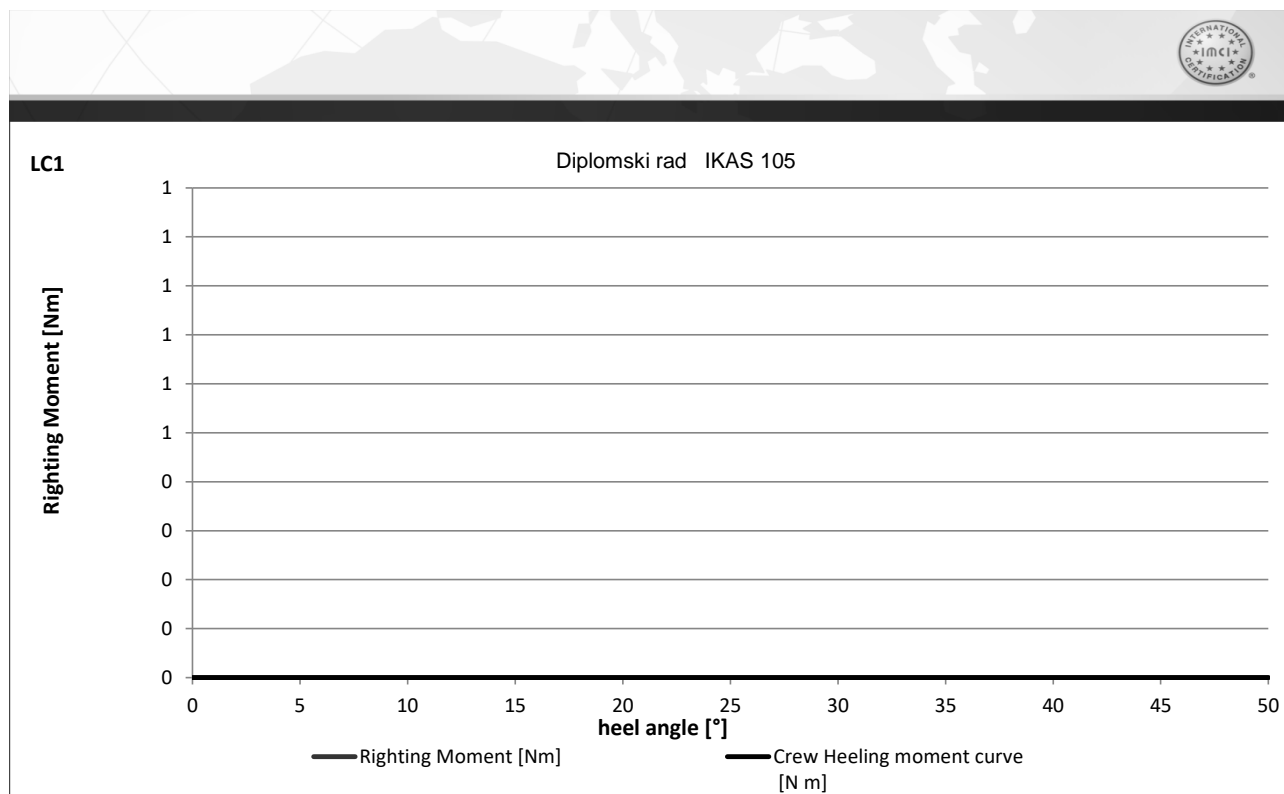



### ISO 12217-1:2017 CALCULATION WORKSHEET No. 5e curve of righting moment LC2

Diplomski rad IKAS 105

insert curve of righting moment in 5° steps in one of following units:

#### OFFSET LOAD TEST

**N m**                      **kg m**                      **m**

**mLC2**

**5016,25**

chosen unit

crew heeling moment curve (either normal or if side decks smaller 0,4m)

heel angle [°]	insert righting arm / moment [Nm, kg m, m]	righting moment [Nm]	righting moment [kg m]	righting arm Gz [m]	crew heeling moment curve [N m]
0		#VALUE!	#VALUE!	error	FALSE
5		#VALUE!	#VALUE!	error	FALSE
10		#VALUE!	#VALUE!	error	FALSE
15		#VALUE!	#VALUE!	error	FALSE
20		#VALUE!	#VALUE!	error	FALSE
25		#VALUE!	#VALUE!	error	FALSE
30		#VALUE!	#VALUE!	error	FALSE
35		#VALUE!	#VALUE!	error	FALSE
40		#VALUE!	#VALUE!	error	FALSE
45		#VALUE!	#VALUE!	error	FALSE
50		#VALUE!	#VALUE!	error	FALSE

point of intersection of righting moment curve and crew heeling moment curve

$\Phi_c$



LC2

Diplomski rad IKAS 105

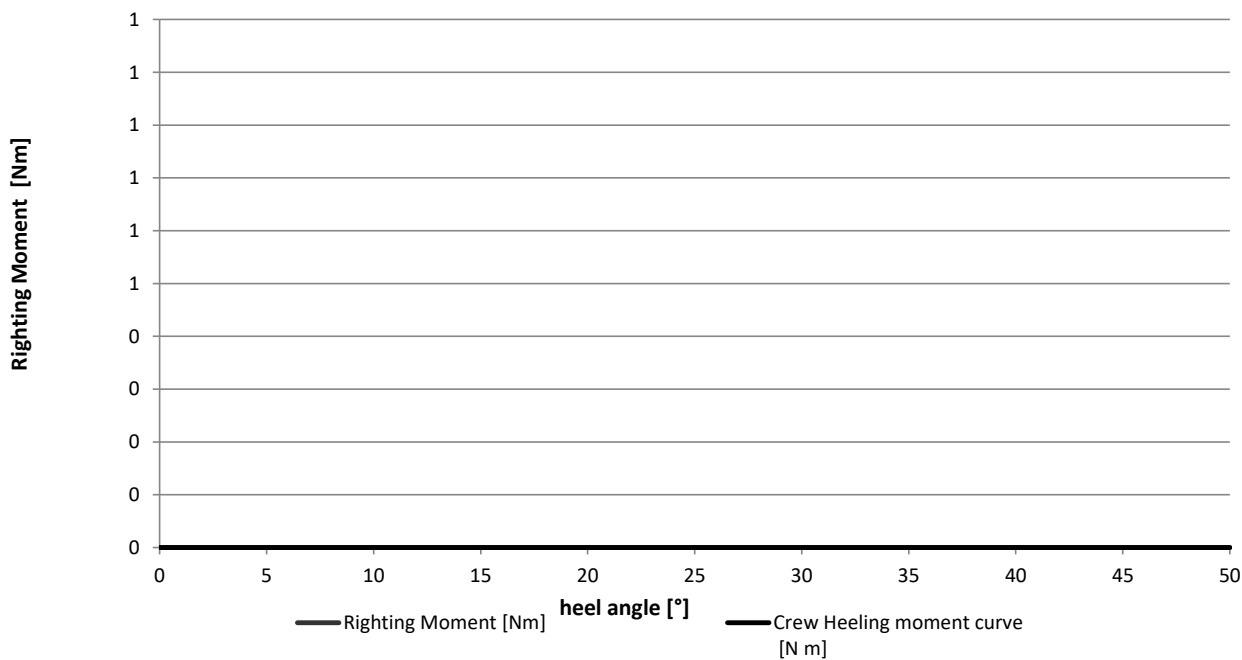

**ISO 12217-1:2017 CALCULATION WORKSHEET No. 6a RESISTANCE TO WAVES+WIND**

Diplomski rad IKAS 105

**Input data:**

**Design categories A and B only**

Item	Symbol	Unit	$m_{LA}$	$m_{MO}$	Ref.
Mass in minimum operating condition	$m_{MO}$	kg		3836,00	3.4.3
Loaded arrival mass	$m_{LA}$	kg	4690,75		3.4.6
Displacement volume (= $m_{MO}/1025$ or $m_{LA}/1025$ )	$V_D$	$m^3$	4,58	3,74	3.4.7
Windage area (of above water profile of boat)	$A_{LV}$	$m^2$	14,30	14,92	3.3.7
Windage area to be used (not to be < $0.5 L_H B_H$ )	$A'_{LV}$	$m^2$	14,30	14,92	6.3.2
Length waterline	$L_{WL}$	m	9,06	8,84	3.3.2
Lever between centroids of above and below water areas	$h$	m	1,02	1,04	6.3.2
Draught of canoe body at the mid-point of the waterline length	$T_M$	m	0,54	0,49	
Downflooding angle	$\phi_{DA}$	degrees	50	48	3.2.2
Calculation windspeed	$v_W$	m/s	17	17	3.5.1



**ISO 12217-1:2017 CALCULATION WORKSHEET No. 6b RESISTANCE TO WAVES+WIND**

Diplomski rad IKAS 105

Rolling in beam waves and wind:

Design categories A and B only

Item	Symbol	Unit	m <sub>LA</sub>	m <sub>MO</sub>	Ref.
Second wind heel equilibrium angle		degrees	64,5	62,3	Fig. 6
Least value of $\phi_{DA}$ , $50^0$ or second wind heel equilibrium angle	$\phi_{A2}$	degrees	50,0	48,0	Fig. 6
Wind heeling moment (1) = $0.53 A'_{LV} h v_W^2$	$M_{W1}$	N-m	2234	2377	6.3.2
Wind heeling moment (2) = $0.30 A'_{LV} (A'_{LV} / L_{WL} + T_M) v_W^2$	$M_{W2}$		2626	2817	
Assumed roll angle Category A = $(25+20/V_D)$	$\phi_R$	degrees	n.a.	n.a.	6.3.2
Category B = $(20+20/V_D)$					
Area 1 (see fig. 6)	$A_1$	any	#VALUE!	#VALUE!	Fig. 6
Area 2 (see fig. 6)	$A_2$	any	4,58	2,69	Fig. 6
Ratio of $A_2/A_1$		--	#VALUE!	#VALUE!	6.3.2
Is ratio of $A_2/A_1$ greater than or equal to 1.0?	YES / NO		#VALUE!	#VALUE!	6.3.2

Resistance to waves:

Item	Symbol	Unit	m <sub>LA</sub>	m <sub>MO</sub>	Ref.
Least value of $\phi_{DA}$ , $50^0$ or second wind heel equilibrium angle		degrees	50,00	48,00	6.3.3
Heel angle when righting moment is maximum	$\phi_{GZMax}$	degrees	65,00	65,00	6.3.3
<b>IF <math>\phi_{GZMax}</math> is greater than or equal to <math>30^0</math></b>					
Max value of righting moment @ $30^0$ heel?	$RM_{30}$	kN m	7,13	5,19	6.3.3a)
Required value of righting moment		kN m	7,00	7,00	6.3.3a)
Is $RM_{30}$ greater than or equal to required max value?			PASS	FAIL	6.3.3b)
Value of righting lever at $30^0 = RM_{30}/(9.806*mass)$	$GZ_{30}$	m	0,155	0,138	3.5.10
Required value of righting lever at $30^0$		m	0,20	0,20	6.3.3a)
Is $GZ_{30}$ greater than or equal to required max value?			FAIL	FAIL	6.3.3a)
<b>IF <math>\phi_{GZMax}</math> is less than <math>30^0</math></b>					
Max value of righting moment	$RM_{MAX}$	kN m	16,56	13,05	6.3.3b)
Required value of $RM_{MAX}$ ( $A = 750/\phi_{GZMax}$ , $B = 210/\phi_{GZMax}$ )		kN m	n.a.	n.a.	6.3.3b)
Is $RM_{MAX}$ greater than or equal to required max value?			n.a.	n.a.	6.3.3b)
Max value of righting lever = $RM_{MAX}/(9.806*mass)$	$GZ_{Max}$	m	0,36000	0,34700	3.5.10
Required max value of righting lever = $6/\phi_{GZMax}$		m	n.a.	n.a.	6.3.3b)
Is $GZ_{MAX}$ greater than or equal to the required max value? PASS / FAIL			n.a.	n.a.	6.3.3b)

Design Category given: NB: Boat must have ratio of $A_2/A_1$ greater than or equal to 1.0, and also get PASS twice under resistance to waves.	<b>#VALUE!</b>
---	----------------

**ISO 12217-1:2017 CALCULATION WORKSHEET No. 6c curve of righting moment  $m_{LA}$**

Diplomski rad IKAS 105

insert curve of righting moment in 5° steps in one of following units:

chosen unit	<b>N m</b>	<b>kg m</b>	<b>m</b>
	m		
chose of $M_w$	<b>MW2</b>		

heel angle [°]	insert Righting Arm/Moment [Nm, kg m, m]	Righting Moment [Nm]	Righting Moment [kg m]	Arm Gz [m]	Wind Heeling moment curve [m]
-25	-0,116	-5.336	-544	-0,116	0,0571
-20	-0,107	-4.922	-502	-0,107	0,0571
-15	-0,093	-4.278	-436	-0,093	0,0571
-10	-0,071	-3.266	-333	-0,071	0,0571
-5	-0,038	-1.748	-178	-0,038	0,0571
0	0,017	782	80	0,017	0,0571
5	0,071	3.266	333	0,071	0,0571
10	0,105	4.830	493	0,105	0,0571
15	0,126	5.796	591	0,126	0,0571
20	0,138	6.348	647	0,138	0,0571
25	0,147	6.762	690	0,147	0,0571
30	0,155	7.130	727	0,155	0,0571
35	0,166	7.636	779	0,166	0,0571
40	0,184	8.464	863	0,184	0,0571
45	0,216	9.935	1.013	0,216	0,0571
50	0,27	12.419	1.267	0,270	0,0571
55	0,33	15.179	1.548	0,330	0,0571
60	0,359	16.513	1.684	0,359	0,0571
65	0,36	16.559	1.689	0,360	0,0571
70	0,34	15.639	1.595	0,340	0,0571

**area A1 and A2 limits**

heel degrees		heel degrees	
A1 from	#VALUE!	to	3,71
A2 from	3,71	to	50,00
			below $M_w$
			above $M_w$

**point of intersection of righting moment curve and wind heeling moment curve**

$\Phi_w$
3,713

$M_w$	2626	Nm
$M_w$	267,8	kg m
$M_w$	0,057	m
$\Phi_w$	3,71	degrees
$\Phi_{A2}$	50,00	degrees
$\Phi_R$	n.a.	degrees

Max $m_{LA}$	0,360	m
heel at GZ max	65,00	degrees

**INTERNATIONAL MARINE CERTIFICATION INSTITUTE**  
INTERNATIONAL NON-PROFIT ASSOCIATION



Heeling arm curve  $m_{LA}$

Diplomski rad IKAS 105

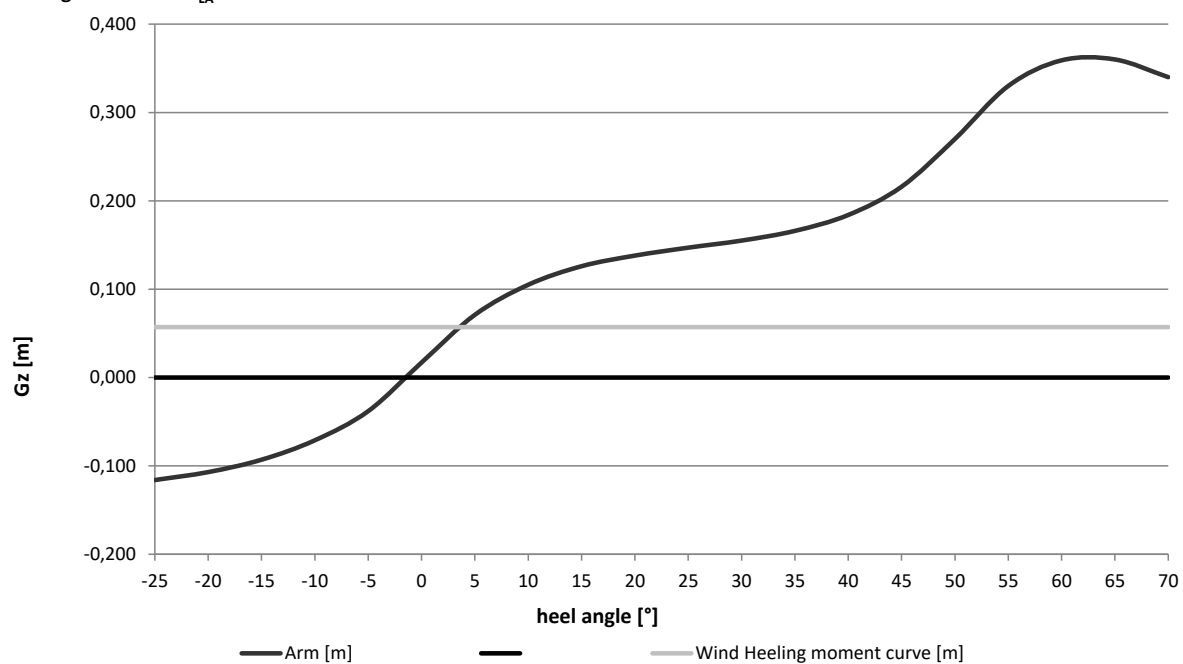

**ISO 12217-1:2017 CALCULATION WORKSHEET No. 6d curve of righting moment  $m_{MO}$**

Diplomski rad IKAS 105

insert curve of righting moment in 5° steps in one of following units:

	<b>N m</b>	<b>kg m</b>	<b>m</b>
chosen unit	m		
chose of $M_w$	MW2		

heel angle [°]	insert Righting Arm/Moment [Nm, kg m, m]	Righting Moment [Nm]	Righting Moment [kg m]	Arm Gz [m]	Wind Heeling moment curve [m]
-25	-0,147	-5.530	-564	-0,147	0,0749
-20	-0,135	-5.078	-518	-0,135	0,0749
-15	-0,119	-4.476	-456	-0,119	0,0749
-10	-0,096	-3.611	-368	-0,096	0,0749
-5	-0,06	-2.257	-230	-0,060	0,0749
0	-0,012	-451	-46	-0,012	0,0749
5	0,036	1.354	138	0,036	0,0749
10	0,072	2.708	276	0,072	0,0749
15	0,096	3.611	368	0,096	0,0749
20	0,112	4.213	430	0,112	0,0749
25	0,125	4.702	480	0,125	0,0749
30	0,138	5.191	529	0,138	0,0749
35	0,155	5.830	595	0,155	0,0749
40	0,18	6.771	690	0,180	0,0749
45	0,219	8.238	840	0,219	0,0749
50	0,261	9.818	1.001	0,261	0,0749
55	0,296	11.134	1.135	0,296	0,0749
60	0,332	12.488	1.274	0,332	0,0749
65	0,347	13.053	1.331	0,347	0,0749
70	0,34	12.789	1.304	0,340	0,0749

**area A1 and A2 limits**

heel degrees		heel degrees	
A1 from	#VALUE!	to	10,60
A2 from	10,60	to	48,00
			below $M_w$
			above $M_w$

**point of intersection of righting moment curve and wind heeling moment curve**

$\Phi_w$
10,602

$M_w$	2817	Nm
$M_w$	287,3	kg m
$M_w$	0,075	m
$\Phi_w$	10,60	degrees
$\Phi_{A2}$	48,00	degrees
$\Phi_R$	n.a.	degrees

Max $m_{MO}$	0,347	m
heel at GZ max	65,00	degrees

**INTERNATIONAL MARINE CERTIFICATION INSTITUTE**  
INTERNATIONAL NON-PROFIT ASSOCIATION



Heeling arm curve  $m_{Mo}$

Diplomski rad IKAS 105

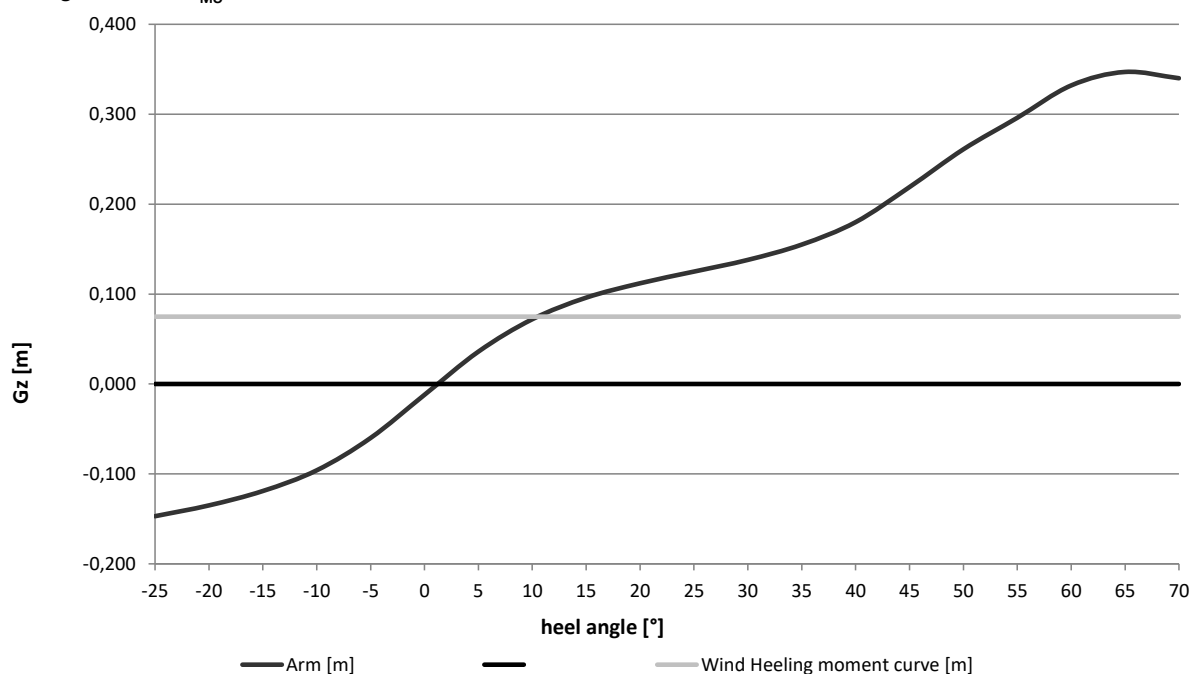

ISO 12217-1:2017 CALCULATION WORKSHEET No.7

HEEL DUE TO WIND ACTION

Diplomski rad IKAS 105

**NB: This sheet is to be completed for both Minimum Operating and Loaded arrival condition**

Initial check:

Design Categories C and D only

Item	Symbol	Unit	m <sub>LA</sub>	m <sub>MO</sub>	Ref.
Windage area (NOT subject to minimum of 0.5 L <sub>H</sub> B <sub>H</sub> )	A <sub>LV</sub>	m <sup>2</sup>		14,92	3.3.7
Length of Hull	L <sub>H</sub>	m	10,50	10,50	3.3.2
Beam of hull	B <sub>H</sub>	m	3,20		3.3.3
Ratio A <sub>LV</sub> /(L <sub>H</sub> B <sub>H</sub> ) at m <sub>MO</sub>		-----	0,44		
Is ratio A <sub>LV</sub> /(L <sub>H</sub> B <sub>H</sub> ) equal to or greater than 0.5?			No		6.4
If answer is NO, no other assessment is required.					

Calculation of wind heeling moment:

Item	Symbol	Unit	m <sub>LA</sub>	m <sub>MO</sub>	Ref.
Length of waterline	L <sub>WL</sub>	m			3.3.2
Draught at the mid-point of L <sub>WL</sub>	T <sub>M</sub>	m			6.3.2
Lever between centroids of above and below water areas	h	m			6.3.2
Calculation wind speed	v <sub>W</sub>	m/s	17		3.5.1
Wind heeling moment M <sub>W1</sub> = 0.53 A <sub>LV</sub> h v <sub>W</sub> <sup>2</sup>	M <sub>W</sub>	Nm	0	0	6.4.2
Wind heeling moment M <sub>W2</sub> = 0.3 A <sub>LV</sub> (A <sub>LV</sub> / L <sub>WL</sub> + T <sub>M</sub> ) v <sub>W</sub> <sup>2</sup>	M <sub>W</sub>	Nm	#DIV/0!	#DIV/0!	6.4.2

Angle of heel due to wind:

Item	Symbol	Unit	m <sub>LA</sub>	m <sub>MO</sub>	Ref.
FROM RIGHTING MOMENT CURVE: angle of heel due to wind	φ <sub>W</sub>	degrees	3,71	10,60	6.4.3
OR ALTERNATIVELY: wind heeling moment M <sub>W</sub> divided by 9.806	M <sub>W</sub>	kg.m	0	0	
Angle of heel due to wind when moment above applied	φ <sub>W</sub>	degrees			6.4.3
Maximum permitted angle of heel during offset load test (from worksheet 5b)	φ <sub>O(R)</sub>	degrees	16,23		6.2.3
Downflooding angle	φ <sub>DA</sub>	degrees	50	48	3.2.2
Maximum permitted angle of heel due to wind = lesser of 0.7φ <sub>O(R)</sub> and 0.7φ <sub>DA</sub>		degrees	11,4	11,4	6-4.3
Is angle of heel due to wind less than permitted value?			Pass	Pass	6.4.3
<b>Design Category possible on wind heeling =</b>					

**ISO 12217-1:2017 CALCULATION WORKSHEET No. 8**

Diplomski rad IKAS 105

**NB: This sheet is to be completed for the Loaded Arrival Condition.**

**calculation not applicable**

Please submit multiple copies of this page if applicable

		Recess	Ref.
<b>Further exemptions according to 6.5.1</b>			
Angle of vanishing stability > 90° ?	YES/NO	Yes	6.5.1a)
Over at least 35% of the periphery is the depth of the recess less than 3% of the max. breadth of the recess (e.g. toe rails, low bulwarks)	YES/NO		6.5.1b)
At least 5% of the bulwark area positioned within the lowest 25% of the bulwark height drains overboard and the bulwark height is less than 12,5% of the maximum breadth of the recess <i>(attention, req. 1) and 2) below must get also a "Yes" to fulfill all requirements)</i>	YES/NO		6.5.1c)
Unobstructed drainage area from the recess on each side of the boat centreline	m <sup>2</sup>		6.5.1d)
Volume of the recess to the recess retention level	m <sup>3</sup>		
Drainage area per side (m <sup>2</sup> ) divided by recess volume (m <sup>3</sup> )			6.5.1d)
Height position of drainage area (lowest 25% / lowest 50% / full depth)			6.5.1d)
Requirements of 6.5.1.d) fulfilled? <i>(attention, req. 1) and 2) below must get also a "Yes"</i>	YES/NO		6.5.1d)
1) the lower edge of the drainage openings are not more than 10 mm above recess sole height for at least 70 % of the width of each opening?	YES/NO	Yes	6.5.1 c) & d)
2) If drainage area is provided by an open or partially open transom, are the openings extend to the outboard sides of the recess sole on both sides?	YES/NO	Yes	6.5.1 c) & d)

Is recess exempt from size limit? If "yes", no further calculation required. 6.5.1

**Calculation methods:**

Item	Symbol	Unit	Value	Ref.
			Recess	
<b>SIMPLIFIED METHOD:</b> Use 1), 2) or 3) below.				
Average freeboard to loaded waterline at aft end of recess	$F_A$	m		6.5.2.1
Average freeboard to loaded waterline at sides of recess	$F_S$	m		6.5.2.1
Average freeboard to loaded waterline at forward end of recess	$F_F$	m		6.5.2.1
Waterline length at mLA	$L_{WL}$	m		
Waterline breadth at mLA (for multihulls insert max. beam waterline $B_{WLmax}$ acc. to ISO 8666)	$B_{WL}/B_{WLmax}$	m		ISO 8666 4.3.4/5
Maximum length of recess at the retention level (see 3.5.11)	$l$	m		6.5.2.4
Maximum breadth of recess at the retention level (see 3.5.11)	$b$	m		6.5.2.4

*- In case of asymmetric recesses (e.g. bowrider, centercockpits, ...), please insert length and breadth of each area below; this allows a more exact calculation using simplified method 1) or 2)*

	max. length	max. breadth	Unit	% loss GMT (option 1)	% loss GMT (option 2)	Ref.
Maximum length and breadth of recess part A			m			6.5.2.2/3
Maximum length and breadth of recess part B			m			6.5.2.2/3
Maximum length and breadth of recess part C			m			6.5.2.2/3
Maximum length and breadth of recess part D			m			6.5.2.2/3
Maximum length and breadth of recess part E			m			6.5.2.2/3
Maximum length and breadth of recess part F			m			6.5.2.2/3
Maximum length and breadth of recess part G			m			6.5.2.2/3
Maximum length and breadth of recess part H			m			6.5.2.2/3
Maximum length and breadth of recess part I			m			6.5.2.2/3

to be continued on page 2

**ISO 12217-1:2017 CALCULATION WORKSHEET No. 8**

page 2

	Symbol	Unit	Value	Ref.
			Recess	
Average freeboard to recess periphery $= (F_A + 2F_S + F_F) / 4$	$F_R$	m	0	6.5.2.1
Category A permitted percentage loss in metacentric height $(GM_T) = 250 F_R / L_H$			n.a.	6.5.2.1
Category B permitted percentage loss in metacentric height $(GM_T) = 550 F_R / L_H$			n.a.	6.5.2.1
Category C permitted percentage loss in metacentric height $(GM_T) = 1\,200 F_R / L_H$			0	6.5.2.1

SIMPLIFIED METHOD: Use 1), 2) or 3) below.				Recess	
<b>1) Loss of <math>GM_T</math> used?</b>					6.5.2.1
Second moment of area of free-surface of recess	$SMA_{RECESS}$	$m^4$	0		6.5.2.2
Metacentric height of boat at $m_{LA}$	$GM_T$	m			6.5.2.2
Calculated percentage loss in metacentric height	$(GM_T) = \frac{102\,500 \times SMA_{RECESS}}{m_{LA} \times GM_T}$				6.5.2.2
<b>2) Second moment of areas used?</b>					6.5.2.1
Second moment of area of free-surface of recess	$SMA_{RECESS}$	$m^4$	0		6.5.2.3
Second moment of area of waterplane of boat at $m_{LA}$	$SMA_{WP}$	$m^4$	0		6.5.2.3
Calculated percentage loss in metacentric height	$(GM_T) = \left( \frac{245 \times SMA_{RECESS}}{SMA_{WP}} \right)$				6.5.2.3
<b>3) Recess dimensions used?</b>					6.5.2.1*
Maximum length of recess at the retention level (see 3.5.11)	$l$	m	0		6.5.2.4
Maximum breadth of recess at the retention level (see 3.5.11)	$b$	m	0		6.5.2.4
Calculated percentage loss in metacentric height	$(GM_T) = 270 \left( \frac{l \times b^3}{L_H \times B_H^3} \right)^{0.7}$				6.5.2.4

<b>Requirement:</b> from results above, applied design category possible?	<b>Fail</b>	6.5.2.1
---	-------------	---------

DIRECT CALCULATION METHOD used?					6.5.3
Percentage full of water = $60 - 240 F / L_H$					6.5.3a)
Wind heeling moment for intended design category	$M_W$	N·m	#DIV/0!		6.5.3b)
Crew heeling moment at $\phi_{GZmax}$		N·m			6.5.3c)
Maximum swamped righting moment up to least of $\phi_D$ , $\phi_V$ or $50^\circ$		N·m			6.5.3d)
Required margin of righting moment over heeling moment		N·m	2345,375		6.5.3d)
Actual margin of righting moment over heeling moment		N·m			6.5.3d)

<b>Applied design category possible?</b>	<b>n.a.</b>	
--	-------------	--

Design category C boats using option 6			
Recess entirely contained within LH/2 of the bow ?			6.5.4
Volume to retention level (see 3.5.9) larger than $(L_H B_H F_M) / 40$ ?			6.5.4
If both questions are answered with 'yes' check requirements below:			
Recess is quickdraining recess either overboard or in the bilge?			6.5.4
Design category possible		<b>n.a.</b>	6.5.4



**ISO 12217-1:2017 CALCULATION WORKSHEET No. 9 Habitable Multihulls & Motor Sailers**

Diplomski rad IKAS 105

**Habitable Multihulls** Is boat habitable multihull acc. to cl. 3.1.8 ?

**NB: Boats complying with the other requirements of this standard for design categories A, B or D are not considered to be susceptible to inversion**

**Boats of design category C:**

Item	Symbol	Unit	Value	Ref.
Beam of hull	$B_H$	m	3,20	3.3.3
Volume of displacement in minimum operation condition	$V_D$	m <sup>3</sup>	3,74	3.4.7
Cube root of volume of displacement in $m_{MO}$	$V_D^{1/3}$	m	1,55	
Height of centroid of $A_{LV}$ above $m_{MO}$ waterline	$h_C$	m		6.6.3
Actual value of $h_C / B_H$	$h_C / B_H$	/		
Boat considered to be susceptible to inversion if either (10) or (11)				6.6.3
(10) when $V_D^{1/3} > 2,6$ and $h_C / B_H > 0,572$			n.a.	6.6.3
(11) when $V_D^{1/3} \leq 2,6$ and $h_C / B_H > 0,22 V_D^{1/3}$				6.6.3
<b>Is boat susceptible to inversion in design category C?</b>			No	
If 'Yes', boat must comply with ISO 12217-2, cl. 7.12 and cl. 7.13 (relevant ISO 12217-2 worksheets to be used)				6.6.1
Boat complies with ISO 12217-2, cl. 7.12 buoyancy when inverted?		Yes / No		6.6.1a)
Boat complies with ISO 12217-2, cl. 7.13 escape after inversion?		Yes / No		6.6.1b)

**Motor Sailer** Is boat defined as "non-sailing" ?   
Is boat fitted with mast and sails?

**NB: Only applicable to non-sailing boats with sails of design cat A or B**

Item	Symbol	Unit	Value	Ref.
Sum of the windage area as defined in 3.3.7 plus the actual profile area, including overlaps, of the largest sail plan suitable for windward sailing in true winds of more than 10 kn to 12 kn (5,1 m/s to 6,2 m/s) and supplied or recommended by the builder as standard;	$A_{max}$	m <sup>2</sup>		6.7.2
Vertical distance between the geometric centres of $A_{max}$ and underwater profile area	$h$	m		6.7.2
Wind speed, 18 m/s for category A and 14 m/s for category B	$v_W$	m/s	n.a.	6.7.2
Heeling moment due to wind ( $M_W = 0,53 A_{max} h v_W^2$ )	$M_W$	Nm	#VALUE!	6.7.2
Maximum righting moment of the boat in $m_{LA}$ up to $\Phi_{DA}$	$RM_{max1}$	Nm	12.419	3.5.11
<b>Wind heeling moment <math>M_W</math> less than 50% of <math>RM_{max1}</math> ?</b>			#VALUE!	6.7.2



**ISO 12217-1:2017 CALCULATION WORKSHEET No. 11 DETECTION + REMOVAL OF WATER**

Diplomski rad IKAS 105

Item	response	Ref.
The internal arrangement facilitates the drainage of water to bilge suction point(s), to a location from which it can be bailed rapidly, or directly overboard?	Yes	6.9.1
Is boat provided with a means of removing water from the bilges in accordance with 15083?	Yes	6.9.2
Table 2 option used for assessment:	2	6.9.3; 5.4 table 2
Can water in boat be detected from helm position?		6.9.3
Methods used: direct visual inspection		6.9.3
transparent inspection panels		6.9.3
bilge alarms		6.9.3
indication of the operation of automatic bilge pumps		6.9.3
other means (specify):		6.9.3

ISO 12217-1:2017 en220801

CALCULATION WORKSHEET No.12

SUMMARY

Design Description:	Diplomski rad IKAS 105		
Design Category intended:	C	Crew Limit:	10
Date:	2023-09-14		

Sheet	Item	Symbol	Unit	Value		
	<b>Length of hull:</b> (as in ISO 8666)	$L_H$	m	10,50		
	<b>Length of waterline in loaded arrival condition</b>	$L_{WL}$	m	9,06		
	<b>Beam of hull:</b> (as in ISO 8666)	$B_H$	m	3,20		
	<b>Masses:</b>					
1	Empty craft mass	$m_{EC}$	kg	1831		
	Maximum load	$m_L$	kg	1561		
	Maximum load for the builder's plate acc. to ISO 14945:2021	$m_{MBP}$	kg	1000		
	Number of portable tanks included in builder's plate weight			0		
	Light craft condition mass	$m_{LC}$	kg	3636		
	Maximum Loaded condition mass = $m_{LC} + m_{ML}$	$m_{LDC}$	kg	5197		
	Loaded arrival condition mass	$m_{LA}$	kg	4691		
	Minimum operating condition mass	$m_{MO}$	kg	3836		
1	<b>Is boat sail or non-sail?</b>	SAIL/NON-SAIL		NON-SAIL		
2	<b>Option selected:</b>	2				
3	<b>Downflooding openings:</b>	Are all requirements met?			Pass	
		Watertightness test for closing appliances done successful?			Pass	
		Exemptions ok or openings considered as possible downflooding openings?			n.a.	
3	<b>Downflooding angle:</b> (Categories A and B only)	degrees	Required	$m_{MO}$	$m_{LA}$	Pass/Fail
		degrees	n.a.	48	50	n.a.
3 & 4	<b>Downflooding height:</b> Worksheet employed for basic height	exempted acc. to 6.1.2.1?		0		
	basic requirement	m	0,62	1,56	Pass	
	reduced height for small openings (only using figures)	m	0,46	1,56	Pass	
	reduced height at outboard (options 3, 4, 6 only)	m	n.a.	1,56	n.a.	
	increased height at bow (options 3, 4, 6 only)	m	n.a.	1,56	n.a.	
5	<b>Off-set load test:</b>	Unit	Required	Actual	Pass/Fail	
	Testing for least stability: maximum heel angle	degrees	< 16,23	2,00	Pass	
	Testing for least freeboard: heeled freeboard margin	m	> 0,15	0,16	Pass	
	Maximum crew limit for stability			10		
	Maximum crew limit for freeboard			10		
6	<b>Resistance to waves and wind:</b> (options 1, 3) at $m_{LA}$ and $m_{MO}$					
	<b>Rolling in beam waves and wind:</b> ratio $A_2/A_1$	-	$\geq 1.0$	#VALUE!	#VALUE!	n.a.
	Resistance to waves: value of $\sigma_{GZMax}$	degrees	---	65,00	65,00	
	value of $RM_{30}$ or $RM_{MAX}$	kNm	7	7,13	5,19	n.a.
	value of $GZ_{30}$ or $GZ_{MAX}$	m	0,2	0,16	0,14	n.a.

7	<b>Heel due to wind:</b> (options 2,4,5,6) at $m_{LA}$ and at $m_{MO}$					n.a.
	at $m_{MLA}$ : heel angle due to wind	degrees	<		3,71	n.a.
	if required at $m_{MO}$ : heel angle due to wind	degrees	<	10,60		n.a.
8	<b>Recess size:</b> (options 1 and 2 except category D)					
	Simplified method: max reduction in $GM_T$	%	≤	0		n.a.
	Direct calculation: margin righting moment over heeling moment	N m	≥	2345,375		n.a.
	For category C boats using option 6; drainage requirements for recesses entirely contained within LH/2 of the bow are fulfilled?					n.a.
9	<b>Habitable Multihulls:</b> Is Category C boat vulnerable to inversion?			Yes / No		
	Complies with Part 2 clause 7.12 for inverted buoyancy?			Pass / Fail		
	Complies with Part 2 clause 7.13 for means of escape?			Pass / Fail		
9	<b>Motor Sailers</b> Complies with requirement for excess of $RM_{MAX}$ over $M_W$ ?			Pass / Fail		
10	<b>Flotation test:</b> (options 3 and 4 only) All preparations completed?			Yes / No		n.a.
	<b>Swamped stability:</b> 5 min after swamping, does boat heel less than 45°?			Pass / Fail		n.a.
	<b>Load test:</b> 5 min after swamping, does boat float level with 2/3 periphery showing?			Pass / Fail		n.a.
	<b>Swamped buoyancy,</b> for boats using option 3: Total buoyant volume > 1,33 $m_{LDC} / 1000$ ?			Pass / Fail		n.a.
	<b>Flotation elements:</b> do all elements comply with all the requirements?			Pass / Fail		n.a.
11	<b>Detection &amp; removal of water</b> are all requirements satisfied?			Yes / No		Yes
<b>NB:</b> Boat must pass all requirements applicable to selected option to be given intended Design Category.						
<b>Design Category given:</b>	<b>C</b>	Assessed by:	<b>Ivan Kašikić</b>			

Documentation of downflooding opening / closing appliance (photo/drawing) attached?

If applicable, cockpit calculation according to ISO 11812 attached ?

If applicable, curve of righting moments in  $m_{MO}$  and  $m_{LA}$  attached ?

Appropriate add. information attached (e.g. photos, drawings,...) ?

If applicable, ISO 12216 calculation attached?

Signature: \_\_\_\_\_