

DIMENZIONIRANJE STRUKTURE TRUPA I IZRADA RAČUNALNOG MODELA ISTRAŽIVAČKOG BRODA / BRODA ZA PODRŠKU RONJENJU

Šuper, Maria

Undergraduate thesis / Završni rad

2024

Degree Grantor / Ustanova koja je dodijelila akademski / stručni stupanj: **University of Rijeka, Faculty of Engineering / Sveučilište u Rijeci, Tehnički fakultet**

Permanent link / Trajna poveznica: <https://um.nsk.hr/um:nbn:hr:190:659403>

Rights / Prava: [Attribution 4.0 International](#) / [Imenovanje 4.0 međunarodna](#)

Download date / Datum preuzimanja: **2025-04-02**



Repository / Repozitorij:

[Repository of the University of Rijeka, Faculty of Engineering](#)



SVEUČILIŠTE U RIJECI

TEHNIČKI FAKULTET

Preddiplomski svučilišni studij brodogradnje

Završni rad

**DIMENZIONIRANJE STRUKTURE TRUPA I IZRADA
RAČUNALNOG MODELA ISTRAŽIVAČKOG BRODA**

Rijeka, rujan 2024.

Maria Šuper
0035227156

SVEUČILIŠTE U RIJECI

TEHNIČKI FAKULTET

Preddiplomski sveučilišni studij brodogradnje

Završni rad

**DIMENZIONIRANJE STRUKTURE TRUPA I IZRADA
RAČUNALNOG MODELA ISTRAŽIVAČKOG BRODA**

Mentori: Prof. dr. sc. Albert Zamarin,

mag. ing. nav. arch. Antonio Filipović

Rijeka, rujan 2024.

Maria Šuper
0035227156

SVEUČILIŠTE U RIJECI

TEHNIČKI FAKULTET

Preddiplomski sveučilišni studij brodogradnje

IZJAVA

Sukladno članku 9. *Pravilnika o završnom radu i završnom ispitu na preddiplomskim sveučilišnim studijima i stručnim studijima* Tehničkog fakulteta Sveučilišta u Rijeci izjavljujem da sam ovaj rad izradila samostalno primjenjujući znanja stečena tijekom studija uz potrebne konzultacije, savjete i koristeći se navedenom literaturom.

Rijeka, rujan 2024.

Maria Šuper

Zahvaljujem se Prof.dr.sc. Albertu Zamarinu i industrijskome komentoru Antoniju Filipoviću na uloženom trudu, vremenu i prenesenom znanju koji su uvelike pomogli pri izradi ovoga rada.

I na kraju, veliko hvala mojoj obitelji koja mi je pružala podršku tijekom studiranja kao i svim kolegama koji su uvijek pomagali i uljepšali mi proces studiranja.

Rijeka, 13.03.2024.

Zavod: Zavod za brodogradnju i inženjerstvo morske tehnologije
Predmet: Konstrukcija broda

ZADATAK ZA ZAVRŠNI RAD

Pristupnik: **Maria Šuper (0035227156)**
Studij: Sveučilišni prijediplomski studij brodogradnje (2020)
Zadatak: **DIMENZIONIRANJE STRUKTURE TRUPA I IZRADA RAČUNALNOG MODELA
ISTRAŽIVAČKOG BRODA / HULL SCANTLINGS AND STRUCTURAL MODEL OF A
RESEARCH AND DIVE SUPPORT VESSEL**

Opis zadatka:

U okviru zadatka potrebno je izvršiti proračun dimenzija strukture trupa na glavnom rebru predloženog istraživačkog broda / broda za podršku ronilačkim aktivnostima u skladu sa pravilima DNV (Det Norske Veritas) klasifikacijskog društva : - uvodno opisati podjelu, specifičnosti namjene i strukturalne konfiguracije istraživačkih brodova, - identificirati i primijeniti opće i specifične zahtjeve DNV-a za dimenzioniranje glavnog rebra s ciljem osiguranja pouzdanosti i sukladnosti s međunarodnim pomorskim standardima, - primijeniti dostupne programske pakete klasifikacijskih društava za izračun/provjeru strukturnih dimenzija prema kriterijima čvrstoće u skladu sa pravilima i propisima, - izraditi nacrt glavnog rebra sa potrebnim detaljima, - izraditi računalni strukturni model (osnovna geometrija) trupa, kao pripremu za strukturnu analizu, koristeći kombinacije dostupnih programskih paketa za opće modeliranje i modeliranje brodskih konstrukcija. Rad će biti izrađen u suradnji sa firmom Lürssen Design Center Kvarner d.o.o.

Rad mora biti napisan prema Uputama za pisanja diplomskih / završnih radova koje su objavljene na mrežnim stranicama studija.

Zadatak uručen pristupniku: 20.03.2024.

Mentor:
prof. dr. sc. Albert Zamarin

Komentor:
Antonio Filipović

Predsjednik povjerenstva za
završni ispit:
prof. dr. sc. Roko Dejhalla

SADRŽAJ

1. UVOD.....	3
1.1. Opis istraživačkog broda	3
1.2. Podjela istraživačkih brodova.....	3
1.3. Strukturalna konfiguracija istraživačkih brodova	4
2. PRAVILA I PROPISI KLASIFIKACIJSKOG DRUŠTVA	5
2.1. Opći zahtjevi DNV-a za dimenzioniranje glavnog rebra	5
2.2. Specifični zahtjevi DNV-a za dimenzioniranje glavnog rebra	6
2.3. Posebni zahtjevi za plovidbu u području leda.....	6
2.3.1. Pojačanje strukture u pojasu leda.....	9
3. DIMENZONIRANJE STRUKTURE TRUPA	10
3.1. Ulazni podatci za brod.....	10
3.1.1. Glavne dimenzije broda	10
3.2. Definiranje modela u Nauticus Hull programu	11
3.3. Provjera uzdužne čvrstoće trupa.....	14
3.4. Analiza strukture	21
3.5. Rezultati izdvojeni iz izvještaja	26
3.5.1. Poprečne pregrade.....	26
3.5.2. Materijali prema poziciji na presjeku.....	27
3.5.3. Sažetak procjene mase strukture trupa.....	28
3.5.4. Limovi poprečnog presjeka.....	29
3.5.5. Uzdužne ukrepe poprečnog presjeka	35
3.5.6. Rebra poprečnog presjeka.....	36
3.5.7. Sponje poprečnog presjeka	37
3.5.8. Rebrenice	38
3.5.9. Napomene nakon proračuna.....	38
3.6. Provjera uzdužne čvrstoće	39
3.6.1. Rezultat proračuna uzdužne čvrstoće.....	41
3.6.2. Provjera panela.....	42
3.6.3. Provjera uzdužnjaka.....	51
3.6.4. Provjera poprečnih nosača.....	65
3.6.5. Provjera spojeva elemenata strukture	69

4. ZAKLJUČAK.....	84
LITERATURA	85
POPIS SLIKA	86
POPIS TABLICA.....	87
POPIS SIMBOLA	88
SAŽETAK	90
SUMMARY	91
PRILOG A.....	92

1. UVOD

1.1. Opis istraživačkog broda

Istraživački brod je plovni objekt izgrađen ili preuređen za oceanografska, meteorološka ili neka druga znanstvena istraživanja. Istraživački brodovi se grade prema potrebama istraživanja tako da mogu imati različite oblike, tehnologije i opremu. Obično raspolažu opremom za određivanje položaja, dubinomjerom, magnetometrom, krmenom sohom, hidrografskim vitlom, dizalicom, laboratorijima, prostorijama za smještaj istraživača i dr.

1.2. Podjela istraživačkih brodova

Istraživački brodovi mogu biti: oceanografski brodovi, hidrografski brodovi, ribarski istraživački brodovi, meteorološki brodovi te polarni istraživački brodovi.

Oceanografski brodovi namjenjeni su za proučavanje fizikalnih, kemijskih, bioloških i geoloških svojstava oceana. Opremljeni su laboratorijima za analizu uzoraka vode, sedimenta i zraka te često imaju i uređaje za uzimanje uzoraka s morskog dna, poput rovera i podvodnih dronova.

Hidrografski brodovi su specijalizirani za kartiranje morskog dna i obalnih područja kako bi se osigurala sigurna plovidba kao i istraživanje karakteristika morskog dna radi eksploatacije nafte i plina. Također provode seizmička istraživanja morskog dna, a za rad im je potrebna oprema poput: sonara, multibeam echosoundera i LIDAR za prikupljanje podataka o dubinama i strukturama podmorja.

Ribolovni istraživački brodovi su fokusirani na proučavanje ribljih populacija i ekosustava. Opremljeni su mrežama, tralima i akustičnim uređajima za praćenje i uzorkovanje ribe.

Meteorološki brodovi su namjenjeni prikupljanju podataka o vremenskim uvjetima na moru. Oprema potrebna za rad uključuje: instrumente za mjerenje atmosferskih uvjeta, kao što su barometri, anemometri i radiometri.

Polarni istraživački brodovi su namjenjeni za istraživanje polarnih regija, posebno Arktika i Antarktika. Opremljeni su za rad u ekstremnim uvjetima, često sa sposobnošću probijanja leda.

Prema specifičnosti namjene istraživački brodovi se također mogu podijeliti na brodove u svrhu znanstvenog istraživanja koji prikupljaju podatke o oceanima, atmosferi, klimatskim promjenama, biologiji mora kao i drugim prirodnim znanostima, brodove u svrhu kartiranja i navigacije koji služe za izradu detaljnih karta morskog dna, obalnih linija i pomorskih puteva, brodove za ekološki monitoring koji prate stanje morskih ekosustava i utjecaja ljudskih aktivnosti na iste te na brodove za istraživanje resursa kao što su riba, nafta i plin.

1.3. Strukturalna konfiguracija istraživačkih brodova

Trup istraživačkih brodova često je jači i stabilniji od komercijalnih brodova zbog potrebe za radom u teškim uvjetima. Polarni istraživački brodovi poput broda koji će se analizirati u ovome radu imaju ojačani trup za probijanje leda. Kao što je i prethodno navedeno uz prostorije namjenjene za smještaj znanstvenika i posade potrebno je odrediti i pozicije prostora koje će zauzimati laboratoriji koji mogu biti ugrađeni ili mobilni kao što je prikazano na Slici 1. Prostori za smještaj znanstvenika i posade uključuje kabine, kuhinju, blagavaonicu i rekreativne prostore, napravljeni su za udobnost tijekom dugih boravaka na moru. Potrebna oprema na takvome brodu uključuje navigacijsku i komunikacijsku opremu poput naprednih sustava za precizno pozicioniranje i sustava za komunikaciju s obalnim stanicama i drugim brodovima također je potrebna i oprema za uzorkovanje i istraživanje kao što su sonde za uzimanje uzoraka vode, sedimenta i zraka, ROV (Remote Operated Vehicle) i AUV (Autonomous Underwater Vehicle) za podvodna istraživanja te sonari i echosunderi za kartiranje (prikupljanje značajki reljefa) morskog dna.

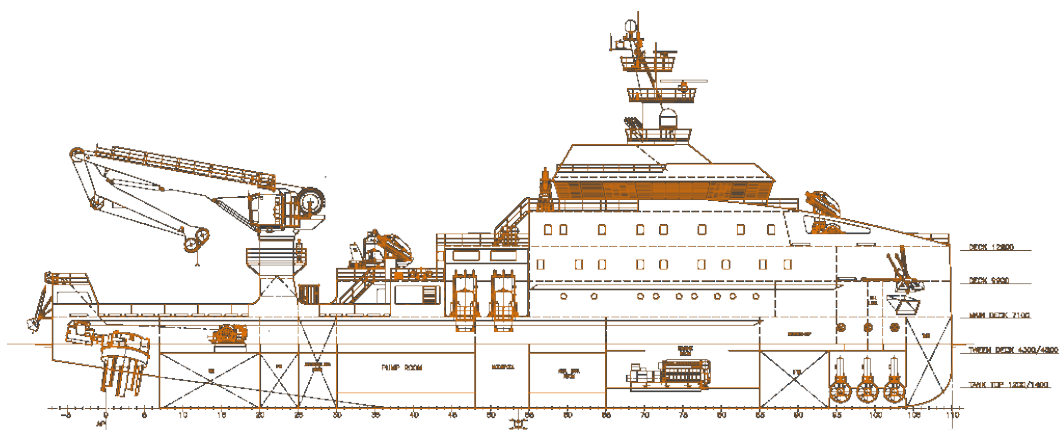

Slika 1. Primjer rasporeda prostora trupa istraživačkog broda [3]

2. PRAVILA I PROPISI KLASIFIKACIJSKOG DRUŠTVA

Det Norske Veritas (DNV) jedno je od vodećih svjetskih klasifikacijskih društva koje pruža standarde i smjernice za projektiranje i izgradnju brodova i pomorskih struktura.

Dimenzioniranje glavnog rebra broda kritičan je element projektiranja koji osigurava strukturalni integritet broda. Za osiguranje pouzdanosti i sukladnosti s međunarodnim pomorskim standardima potrebno je primjeniti opće i specifične zahtjeve DNV-a.

DNV je neovisni pružatelj usluga osiguranja i upravljanja rizicima, koji djeluje u više od 100 zemalja s ciljem očuvanja života, imovine i okoliša. Kao pouzdan glas mnogih najuspješnijih organizacija na svijetu, koriste široko iskustvo i duboko stručno znanje kako bi unaprijedili sigurnost i održivu izvedbu, postavili industrijske standarde te inspirirali i osmislili rješenja.

2.1. Opći zahtjevi DNV-a za dimenzioniranje glavnog rebra

Pri izradi broda potrebno je koristiti certificirane materijale koji zadovoljavaju DNV standarde za čelik i druge materijale. Pri dimenzioniranju elemenata potrebno je uzeti u obzir geometriju broda, uključujući oblik trupa i raspored drugih strukturnih elemenata te specifikaciju minimalnih dimenzija za glavno rebro uključujući debljinu, visinu i širinu. Potrebno je provesti analizu različitih vrsta opterećenja koja uključuju statička, dinamička i valna udarna opterećenja. Analiza se provodi koristeći metode kao što je metoda konačnih elementa (FEA) za modeliranje i simulaciju opterećenja. Nužno je provesti proračun minimalne čvrstoće potrebne za glavno rebro kako bi izdržalo predviđena opterećenja kao i uvesti sigurnosne faktore prema DNV-ovim smjernicama kako bi se osigurala dugotrajnost i otpornost na zamor materijala.

2.2. Specifični zahtjevi DNV-a za dimenzioniranje glavnog rebra

Primjena zahtjeva za dimenzioniranje glavnog rebra može se prikazati kroz izbor materijala, proračun dimenzija, strukturnu analizu, implementaciju i inspekciju te dokumentaciju. Pri izboru materijala bitno je odrediti čelik visoke čvrstoće prema DNV standardima, npr. čelik s oznakom DNV GL Grade A. Na temelju opterećenja i razmaka između rebara proračunava se minimalna debljina i druge dimenzije rebra. Provođenjem simulacije analize konačnih elemenata kako bi se analizirala čvrstoća strukture na predviđena opterećenja i identificirale potencijalne kritične točke. Izrada i montaža strukturnih elemenata glavnog rebra i trupa općenito se provodi prema projektu te se sukladno provode inspekcije zavarivanja. Potrebno je provoditi redovitu inspekciju nakon ugradnje kako bi se osigurala dugotrajnost i otkrili potencijalni problemi tijekom vijeka trajanja broda. Kompletna dokumentacija, koja uključuje proračune, crteže, specifikacije materijala i izvješća o inspekciji, se priprema za reviziju od strane DNV-a radi dobivanja certifikata klase. Primjenom ovih koraka i pridržavanjem smjernica klasifikacijskog društva osigurava se da glavno rebro broda zadovoljava sve potrebne standarde za sigurnost i pouzdanost.

2.3. Posebni zahtjevi za plovidbu u području leda

Klasifikacijska društva, kao što su DNV GL, ABS, ili Lloyd's Register, pružaju različite kategorije klase plovidbe u ledenom području koje pokazuju razinu pojačanja za led (Tablica 2). Pravila za klasifikaciju plovidbe u ledenim područjima obuhvaćaju zahtjeve za: čvrstoću trupa broda, propulziju broda te raznu opremu na brodu. Dodatna „ICE“ klasa se odnosi na plovila koja tijekom službi mogu ploviti morima djelomično ili potpuno zaleđenom površinom, uobičajeno su to sjeverna Baltička područja u zimi ili područja sa sličnim uvjetima. Različite klase određene su razlikom debljine leda koji se susreće u plovidbi, Tablica 1.

Tablica 1. Klase za područja plovidbe vodom prekrivenom ledom

Ice class	h_o [m]	h [m]
Ice(1A*F) and Ice(1A*)	1.0	0.35
Ice(1A)	0.8	0.30
Ice(1B)	0.6	0.25
Ice(1C)	0.4	0.22

Tablica 2. Definicija klasa za područja plovidbe vodom prekrivenom ledom

<i>Klasa</i>	<i>Kvalifikacija</i>	<i>Namjena broda</i>	<i>Ekvivalentna Finsko-Švedska klasa led</i>
Ice	1A*F	Brodovi s velikom snagom za opću plovidbu u teškom ledu Baltika. Obično sposobni ploviti u teškim uvjetima leda bez pomoći ledolomaca.	
	1A*	Brodovi namijenjeni plovidbi u vodi s ledom. Jednogodišnji led debljine do 1.0 m. Obično sposobni ploviti u teškim uvjetima leda bez pomoći ledolomaca..	1A Super
	1A	Brodovi namijenjeni plovidbi u vodi s ledom. Jednogodišnji led debljine do 0.8 m. Sposobni ploviti u teškim uvjetima leda uz pomoć ledolomaca kada je to potrebno.	1A
	1B	Brodovi namijenjeni plovidbi u vodi s ledom. Jednogodišnji led debljine do 0.6 m. Sposobni ploviti u umjerenim uvjetima leda uz pomoć ledolomaca kada je to potrebno.	1B
	1C	Brodovi namijenjeni plovidbi u vodi s ledom. Jednogodišnji led debljine do 0.4 m. Sposobni ploviti u blagim uvjetima leda uz pomoć ledolomaca kada je to potrebno.	1C

Granice pojačanja zbog pojave leda u plovidbi su određene gornjom ledenom vodenom linijom (UIWL) i donjom ledenom vodenom linijom (LIWL) koje označuju gazove pri tim ekstremnim uvjetima, Slika 2.

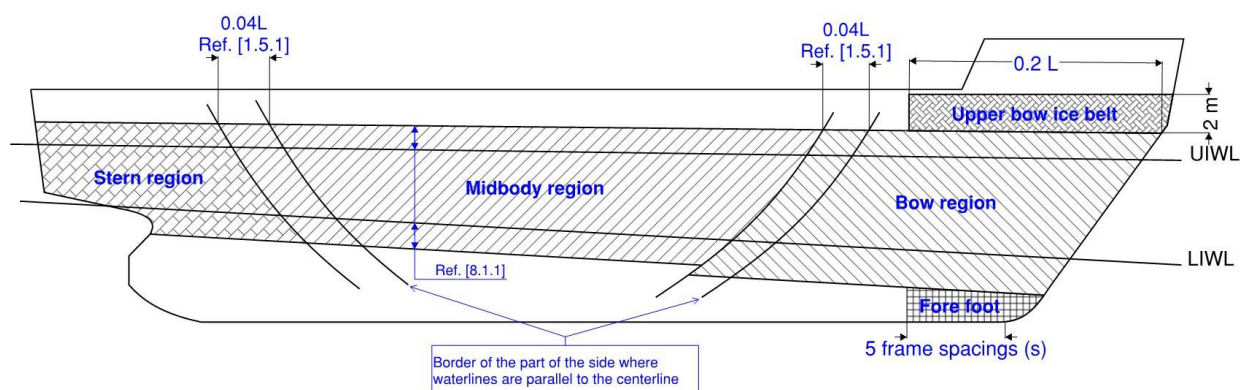

Slika 2. Prikaz područja ledenog pojasa

Posebni zahtjevi koji su određeni „Ice“ klasom obuhvaćaju materijale tako da postavljaju zahtjev da korišteni materijal mora biti otporan na krhkost i degradaciju na niskim temperaturama. Čelik i druge legure se moraju testirati i certificirati za upotrebu u hladnoj klimi. Plovila i strukture moraju biti dizajnirani da izdrže nakupljanje leda, koji može povećati težinu i opterećenje na strukturu, te utjecati na stabilnost i sigurnost. Oprema i infrastruktura trebaju imati sustave za grijanje i izolaciju kako bi spriječili zamrzavanje ključnih komponenti, kao što su motori, cjevovodi, i električni sustavi.

Artička područja i Sjeverni Baltik može imati značajnu debljinu leda tijekom zime, pa plovila moraju biti posebno ojačana kako bi se osiguralo da mogu sigurno prolaziti kroz led i izdržati uvjete poput zbijenog leda ili leda koji se stapa uslijed topljenja i ponovnog zamrzavanja. Brod koji će se promatrati u ovome radu je ledene klase 1C tj. namijenjen je za plovidbu u laganim ledenim uvjetima.

2.3.1. Pojačanje strukture u pojasu leda

Nakon određivanja „Ice“ klase potrebno je pojačati određene djelove strukture unutar ledenog pojasa. Potrebno je ojačati trup broda dodatnom povećanom debljinom čelika, posebno na pramcu i u području kobilice gdje je pritisak leda najveći. Također je potrebno dodati dodatna rebra kako bi se poboljšala čvrstoća trupa i otpornost na udare leda. Propeleri su izrađeni od materijala otpornijih na lom, poput bronce ili posebnih legura čelika kako bi izdržali udare od led. Pramac broda može biti oblikovan ili opremljen kako bi olakšalo probijanje kroz led. Brod s dodjeljenom „Ice“ klasom ima oznaku klase na bokovima koja se naznačava prema Slici 3.

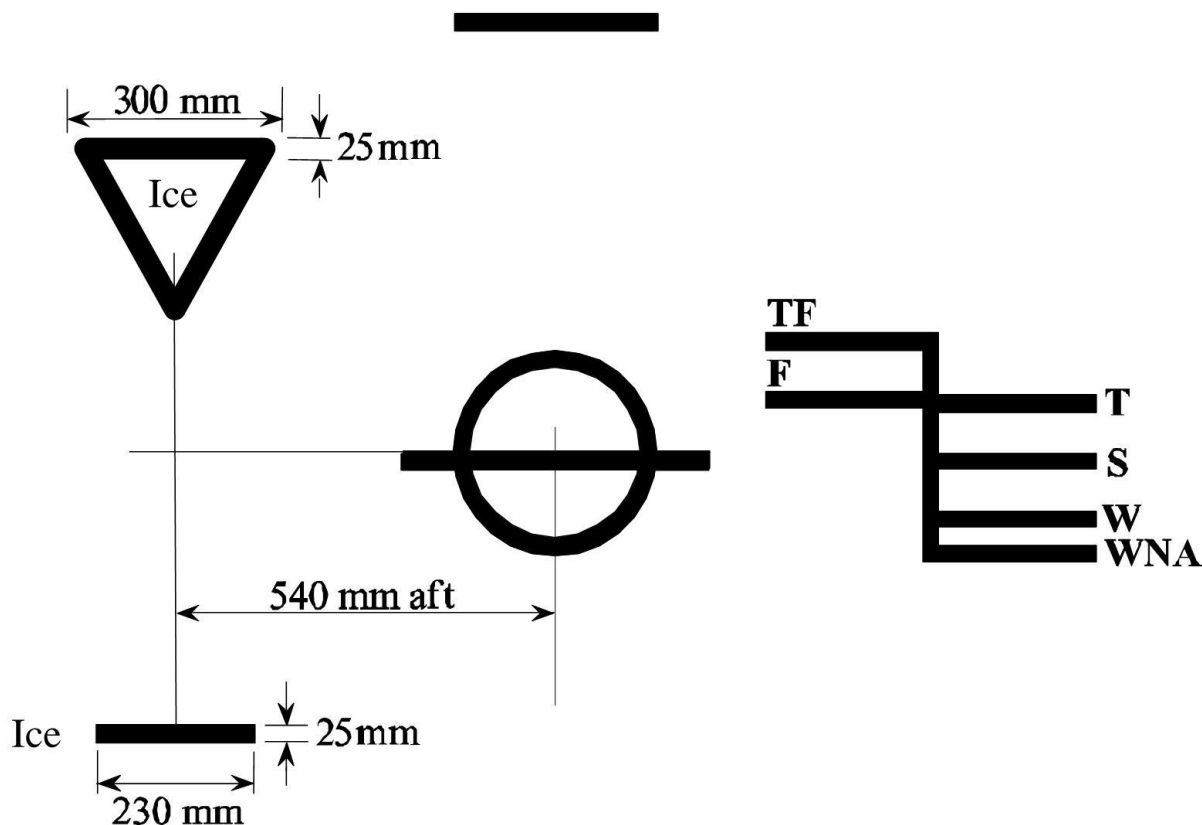

Slika 3. Označavanje „Ice“ klase na trupu broda

Pravila i klasifikacije vezane uz ledena područja su ključna za osiguranje sigurnosti, dugovječnosti i učinkovitosti u izuzetno hladnim uvjetima. Za promatrani brod bitno je naglasiti da pravila postavljaju zahtjeve za plovila namjenjena pružanju podrške ronilačkim operacijama, s posebnim naglaskom na sposobnost sigurnog održavanja pozicije tijekom ronjenja, zahvaljujući ugrađenim azipodima kao glavnom porivnom opremom.

3. DIMENZIONIRANJE STRUKTURE TRUPA

Cilj ove studije je odrediti i dimenzionirati strukturu trupa istraživačkog broda koji plovi u hladnim podnebljima. Dimenzioniranje svih konstrukcijskih elemenata provedeno je u računalnom programu Nauticus Hull. Svi proračunati elementi zadovoljavaju uvjete lokalne i globalne čvrstoće.

3.1. Ulazni podatci za brod

3.1.1. Glavne dimenzije broda

Duljina između perpendikulara, L_{PP}	[m]:	123.695
Duljina prema pravilima, L	[m]:	119.984
Duljina nadvođa, L_{LL}	[m]:	123.754
X-pozicija za krmeni kraj vodene linije za duljinu nadgrađa.....	[m]:	115.000
Projektna širina, B	[m]:	25.000
Projektni gaz, T	[m]:	7.200
Projektna dubina, D	[m]:	11.300
Projektna dubina nadvođa, D_{LL}	[m]:	11.300
Blok koeficijent, C_B	:	0.650
Maksimalna radna brzina, V	[čv]:	15.000

3.2. Definiranje modela u Nauticus Hull programu

U ovome radu korišten je softver Nauticus Hull razvijen od strane klasifikacijskog društva Det Norske Veritas za izračun i provjeru čvrstoće trupa broda. U softveru su implementirana klasifikacijska pravila za globalnu i lokalnu čvrstoću, pravila za stabilnost i plovnost, pravila za otpornost na led, pravila za dinamička opterećenja i pravila specifična za klase. Osim same provjere čvrstoće, Nauticus Hull je također alat kojim se definira struktura na način koji omogućava da se računalni model koristi u kasnijim fazama projekta. Taj model može poslužiti kao osnova za nastavak izrade klasifikacijske i radioničke dokumentacije, odnosno detaljnih nacrti potrebnih za izradu broda. Također usvojeni model iz Nauticus Hull-a može biti korišten za daljnje analize poput analize metodom konačnih elemenata ukoliko se procijeni da je potrebno dodatno testiranje ili optimizacija strukture.

Pokretanjem računalnog programa Nauticus Hull izabiremo opciju kreiranja novog projekta čime se otvara korisničko sučelje prikazano na slici 4.

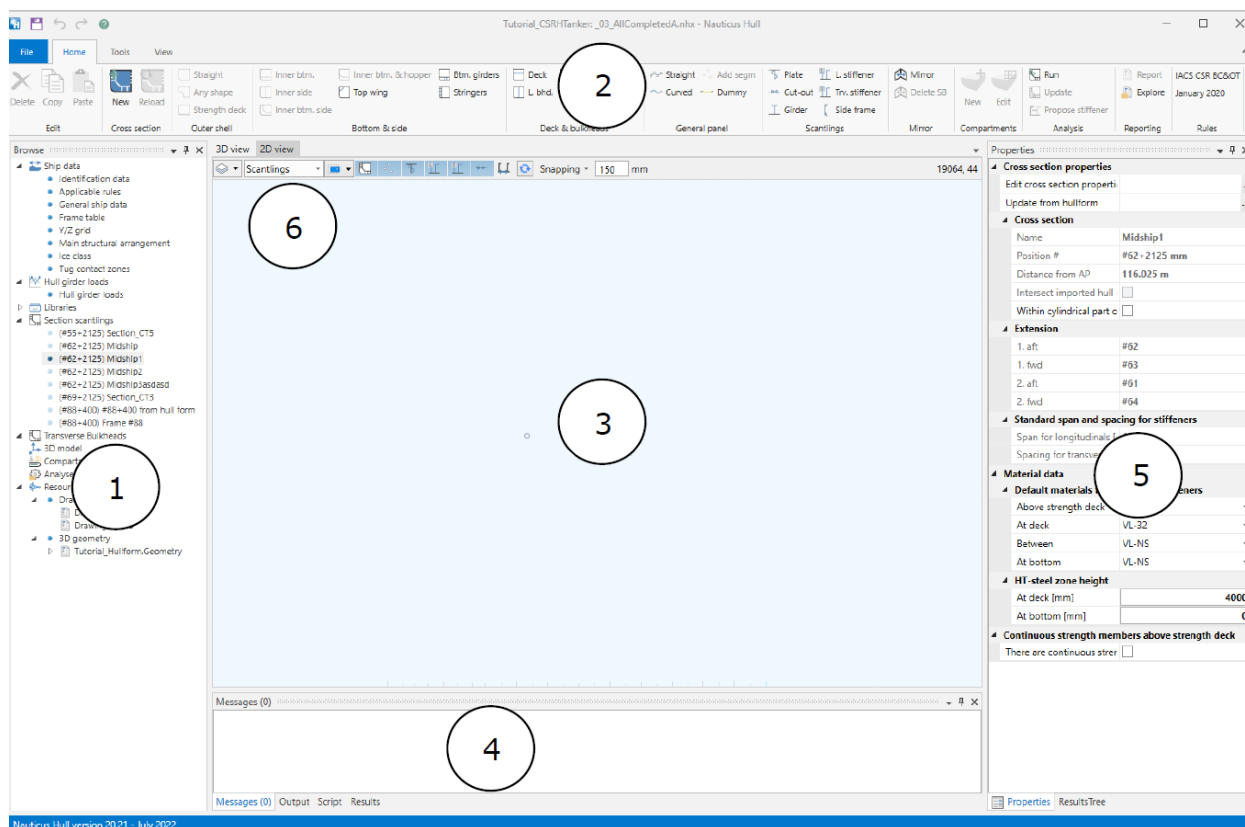

Slika 4. Korisničko sučelje u Nauticus Hull-u

Brojčano su označeni djelovi korisničkog sučelja:

- 1 – Navigacijsko stablo
- 2 – Traka s alatima/Izbornik
- 3 – Radna površina
- 4 – Izlazne napomene
- 5 – Svojstva i rezultati
- 6 – Odabir prikaza

Novi projekt se započinje izborom pravila po kojima će se provoditi analiza te unošenjem podataka o osnovnim značajkama broda prema tablici iz priloga A. Slijedi definiranje materijala modela prema kojemu će se graditi struktura. U ovome radu korišten je isključivo brodograđevni čelik tipa VL-36. Brodograđevni čelik tipa VL-36 poznat je po svojoj visokoj čvrstoći i otpornosti na koroziju, što ga čini pogodnim za izgradnju brodskih trupova, paluba i drugih strukturalnih komponenata koje su izložene morskim uvjetima. Glavna svojstva materijala mogu se iščitati sa slike 5.

Name	Density (kg/m3)	Yield stress (N/mm2)	Material factor, k (-)	Tensile strength (N/mm2)	Young's modulus (N/mm2)	Shear modulus (N/mm2)	Material type
VL-NS	7850	235	1	400	206000	79231	Standard steel ▼
VL-32	7850	315	0.78	440	206000	79231	Standard steel ▼
VL-36	7850	355	0.72	490	206000	79231	Standard steel ▼
VL-40	7850	390	0.68	510	206000	79231	Standard steel ▼
VL-47	7850	460	0.68	570	206000	79231	Standard steel ▼
VL-40FA	7850	390	0.68	510	206000	79231	Standard steel ▼
							▼

Slika 5. Izbornik sa svojstvima materijala

VL-36 je legirani čelik, što znači da sadrži dodatke kao što su nikal, molibden ili mangan, koji poboljšavaju njegove mehaničke osobine i otpornost na koroziju. Brodograđevni čelici s oznakama poput VL-36 prolaze stroge kontrole kvaliteta kako bi se osigurala njihova dugotrajnost i sigurnost u ekstremnim uvjetima na moru.

Prije nego se krene definirati geometrija presjeka potrebno je unijeti podatke o razmaku rebara i poziciji rebara i nepropusnih pregrada po duljini broda kao što je vidljivo na slici 6.

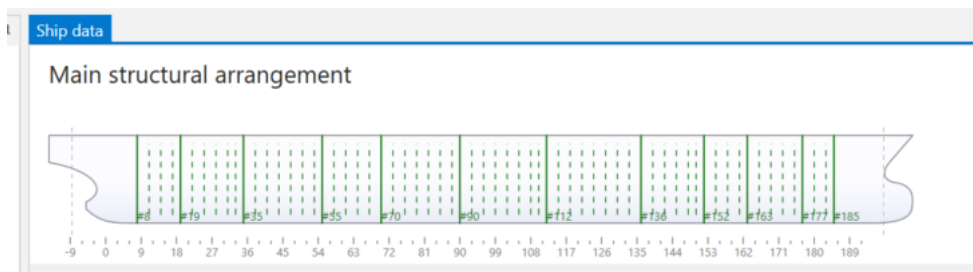

Slika 6. Glavni raspored strukture

Kako bi se lakše definirala geometrija modela za analizu potrebno je napraviti mrežu prema tipičnim razmacima komponenta strukture prema y i z osi. Također je potrebno definirati pozicije nepropusnih pregrada i okvirnih rebara duž broda. Za provjeru zahtjeva za ojačanje protiv leda unose se dodatni podaci o brodu koji moraju biti definirani pod klasom otpornosti na led. Propisani zahtjevi za lokalna opterećenja strukturnih elemenata na led se odnose na limove, ukrepe, poprečne ukrepe i glavne okvire. Kako bi se izračunao tlak uslijed djelovanja leda potrebno je poznavati iznos istisninu i gaz broda. Definiranjem ledenih vodenih linija određuje se koje će se elemente strukture provjeriti prema zahtjevima za pojačanje trupa broda uslijed pojave leda.

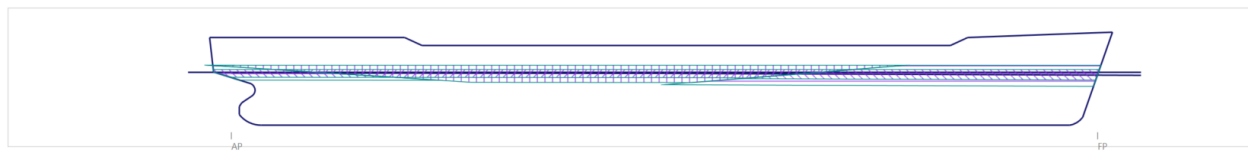

Slika 7. Definirani ledeni pojas

3.3. Provjera udužne čvrstoće trupa

Pojam uzdužne granične čvrstoće trupa može se definirati kao stanje naprezanja i deformacije na razini trupa koje odgovara maksimalnom opterećenju koje konstrukcija može izdržati. Svako daljnje povećanje momenta savijanja dovodi do kolapsa trupa broda. To stanje je posljedica kolapsa pojedinačnih strukturnih elemenata od kojih se sastoji brodska konstrukcija. Vrijednost graničnog momenta dobije se zbrajanjem doprinosa svih elemenata koji sudjeluju u uzdužnoj čvrstoći trupa. U obzir se moraju uzeti stupanj deformiranosti i čvrstoća nakon kolapsa pojedinih strukturnih elemenata. S obzirom na način opterećenja, ovisno o tome nalazi li se brod na valnom brijegu ili između dva vala u valnom dolu, konstrukcijski elementi mogu biti u stanju vlačnog ili tlačnog naprezanja, što znači da su neki elementi deformirani na način da su izduženi dok su neki uslijed tlačnog naprezanja skraćeni. Konačni rezultat ovakvog stanja jest određena zakrivljenost trupa.

Globalni momenti savijanja računaju se prema pravilima DNV-a Pt.3.Ch.4.Sec.4. [2.2.2.]:

$$M_{sw-h-min} = f_{sw}(171C_wL^2B(C_B + 0,7) \cdot 10^{-3} - M_{wv-h-mid}) \quad (3.1.)$$

$$M_{sw-s-min} = -0,85f_{sw}(171C_wL^2B(C_B + 0,7) \cdot 10^{-3} + M_{wv-s-mid}) \quad (3.2.)$$

$$M_{wv-h} = 0,19 \frac{f_R}{0,85} f_{nl-vh} f_m f_p C_w L^2 B C_B \quad (3.3.)$$

$$M_{wv-s} = -0,19 \frac{f_R}{0,85} f_{nl-vs} f_m f_p C_w L^2 B C_B \quad (3.4.)$$

$$M_{wh} = f_p \left(0,31 + \frac{L}{2800}\right) f_m C_w L^2 T_{LC} C_B \quad (3.5.)$$

pri čemu:

f_{sw} = distribucijski faktor po duljini broda = 1,0

$M_{wv-h-mid}$ = moment savijanja uslijed horizontalnog vala za procjenu čvrstoće na paralelnom srednjaku u uvjetima progiba

$M_{wv-s-mid}$ = moment savijanja uslijed horizontalnog vala za procjenu čvrstoće na paralelnom srednjaku u uvjetima progiba

f_R = faktor povezan s operativnim profilom

f_{nl-vh} = koeficijent nelinearnih efekata u progibu

f_{nl-vs} = koeficijent nelinearnih efekata u progibu

f_p = faktor opterećenja

f_m = faktor materijala

Rezultat je prikazan u Tablicama 3 i 4, te raspodjelom momenata savijanja po duljini broda, Slika 8 i Slika 9.

Tablica 3. Momenti savijanja na mirnoj vodi

Momenti savijanja na mirnoj vodi	[kNm]
u pregibu (hogging)	322019
u progibu (sagging)	-210003

Tablica 4. Momenti savijanja na valovima

Momenti savijanja na valovima	[kNm]
u pregibu (hogging)	370464
u progibu (sagging)	-445420
horizontalni	198142

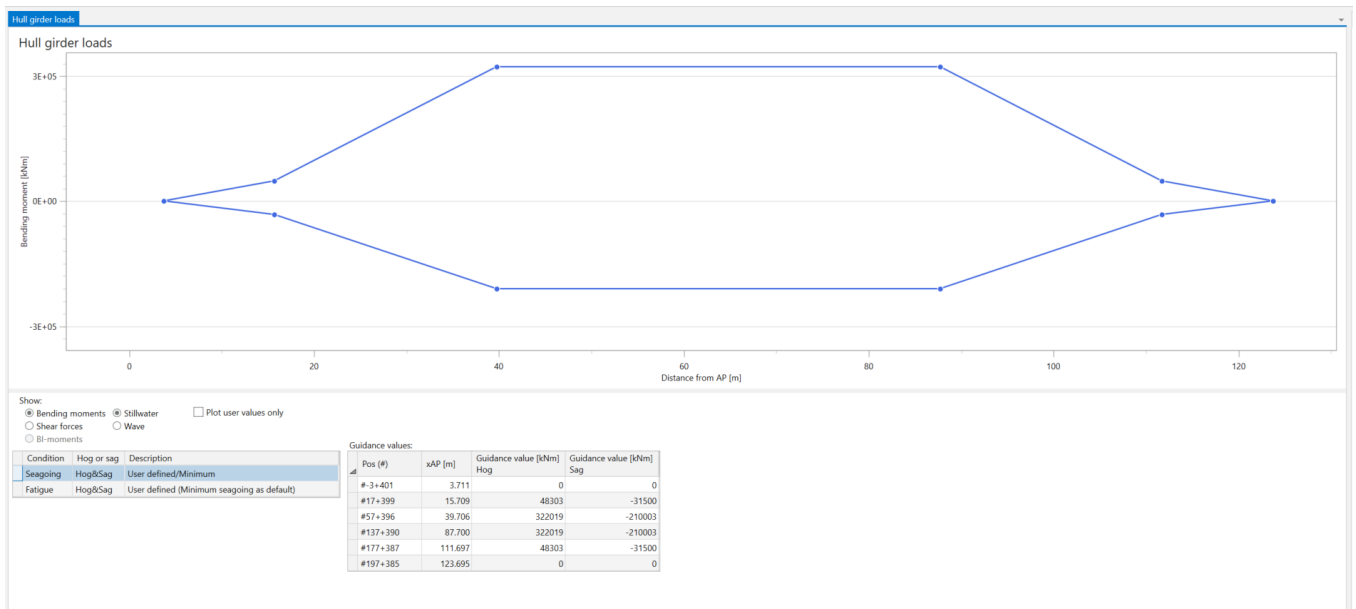

Slika 8. Dijagram momenata savijanja na mirnoj vodi

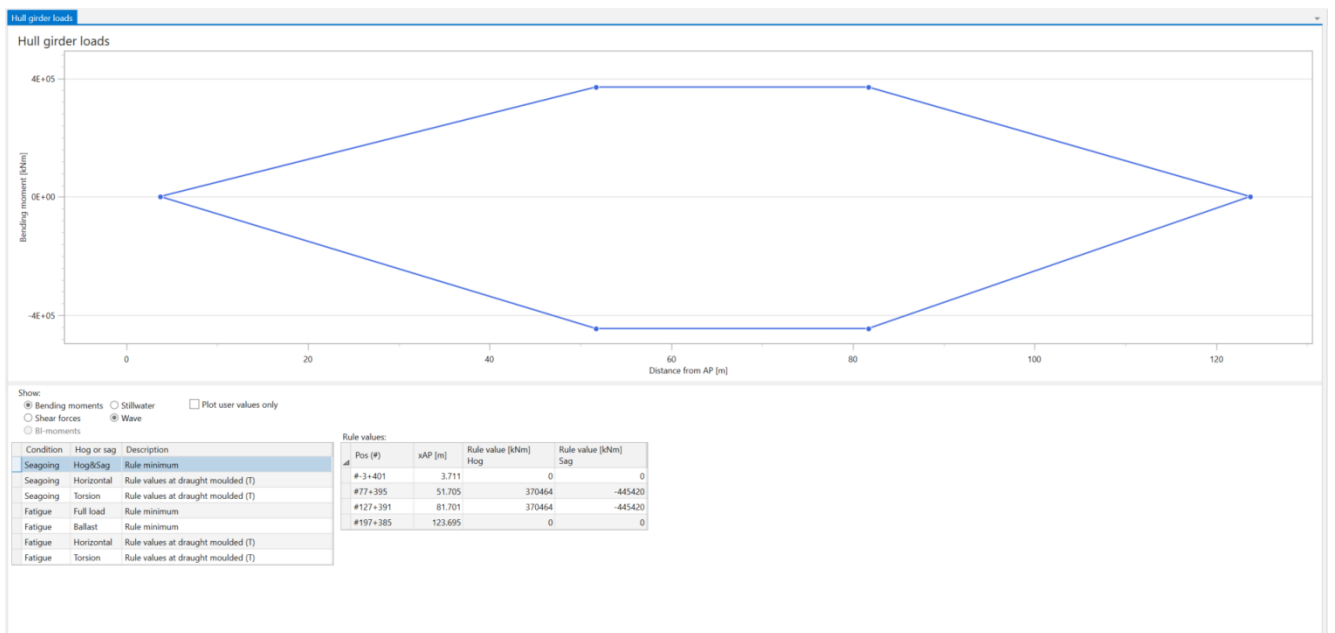

Slika 9. Dijagram momenata savijanja na valu

Sile smicanja računaju se prema pravilima DNV-a Pt.3.Ch.4.Sec.4. [2.4.2.]:

$$Q_{sw-pos-min} = \frac{5f_{qs}M_{sw-min}}{L} \quad (3.6.)$$

$$Q_{sw-neg-min} = \frac{-5f_{qs}M_{sw-min}}{L} \quad (3.7.)$$

$$Q_{wv-pos} = 0,52f_{q-pos}f_pLBC_B \quad (3.8.)$$

$$Q_{wv-neg} = 0,52f_{q-neg}f_pLBC_B \quad (3.9.)$$

pri čemu:

f_{qs} = distribucijski faktor po duljini broda =0,8

f_{q-pos} = distribucijski faktor po duljini broda za pozitivne smične sile

f_{q-neg} = distribucijski faktor po duljini broda za negativne smične sile

Rezultat je prikazan u Tablicama 5 i 6, te raspodjelom sila smicanja po duljini broda, Slika 10 i Slika 11.

Tablica 5. Sile smicanja na mirnoj vodi

Sile smicanja na mirnoj vodi	[kN]
pozitivne	10735
negativne	-10735

Tablica 6. Sile smicanja na valu

Sile smicanja na valu	[kN]
pozitivne	7112
negativne	-7112

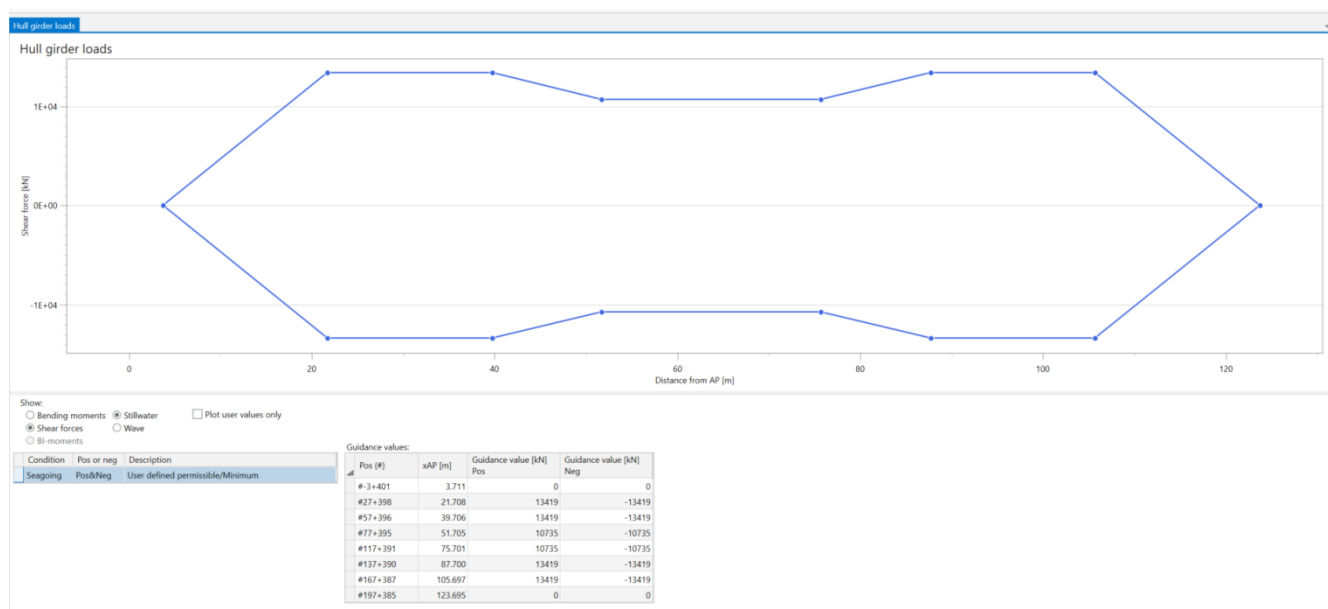

Slika 10. Dijagram sila smicanja na mirnoj vodi

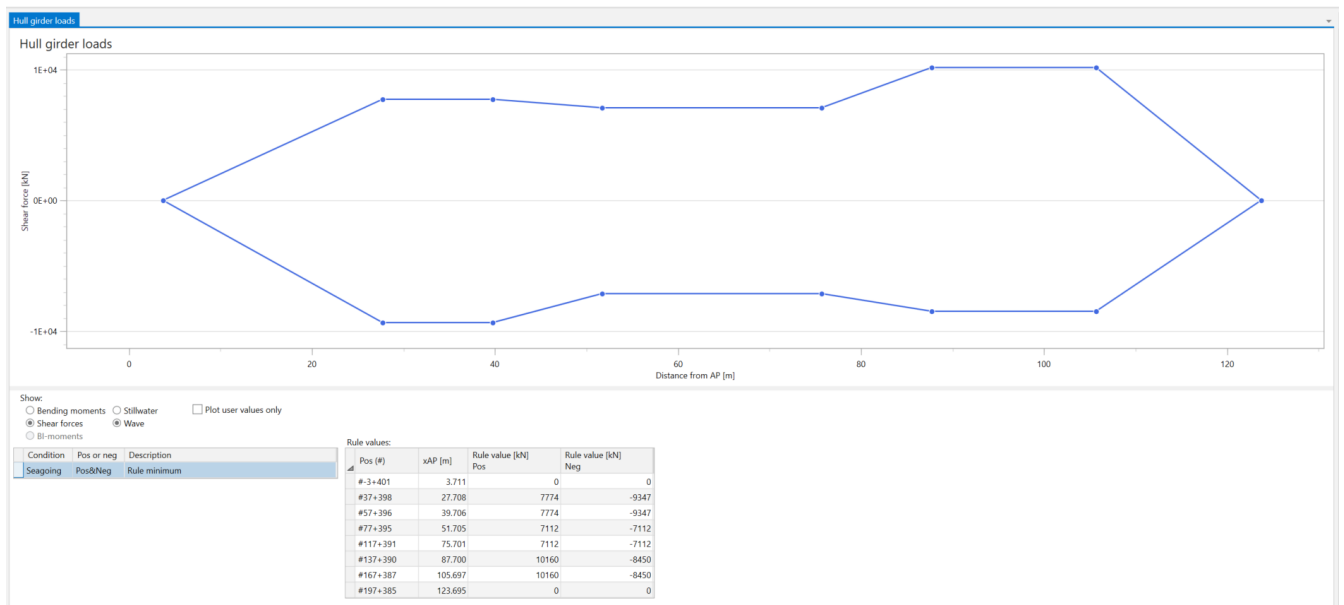

Slika 11. Dijagram sila smicanja na valu

Nakon definiranja materijala koji će se koristiti te opterećenja broda potrebno je generirati presjek glavnog rebra postavljanjem mreže za analizu. Prvo se definira panel vanjske oplata koji se sastoji od dna, uzvoja i boka broda pa se definiraju paneli paluba i prostora na brodu poput tankova u dvodnu i uzdužnih pregrada na palubama.

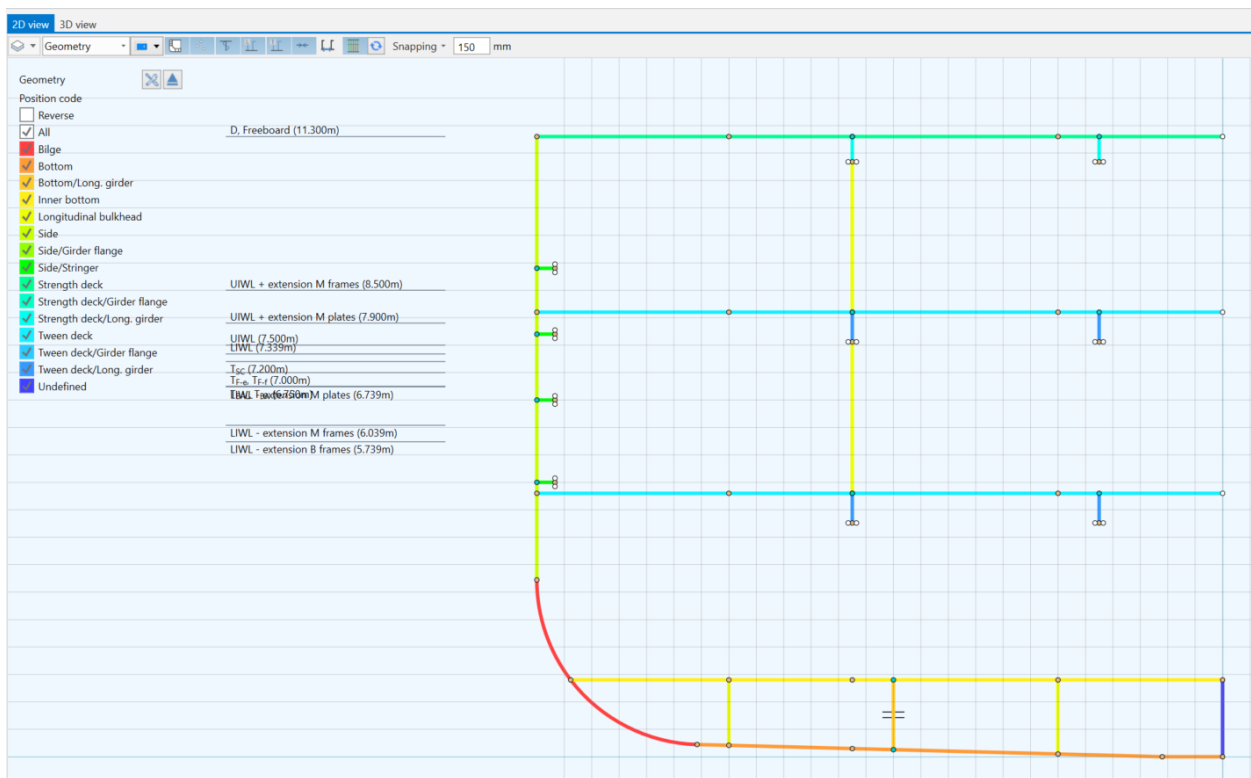

Slika 12. Definirane pozicije geometrije presjeka

Nakon definiranja panela i njihovih pozicija postavlja se oploćenje određene debljine na koje se postavlja uzdužni strukturni elementi. Poprečni elementi se opisuju nakon definiranja uzdužnih elemenata kako bi dodatno ojačali strukturu kao i u područjima gdje je to potrebno npr. područje ledenog pojasa. Konačno se definiraju rebra kako bi se dobio konačni oblik geometrije presjeka prema Slici 13.

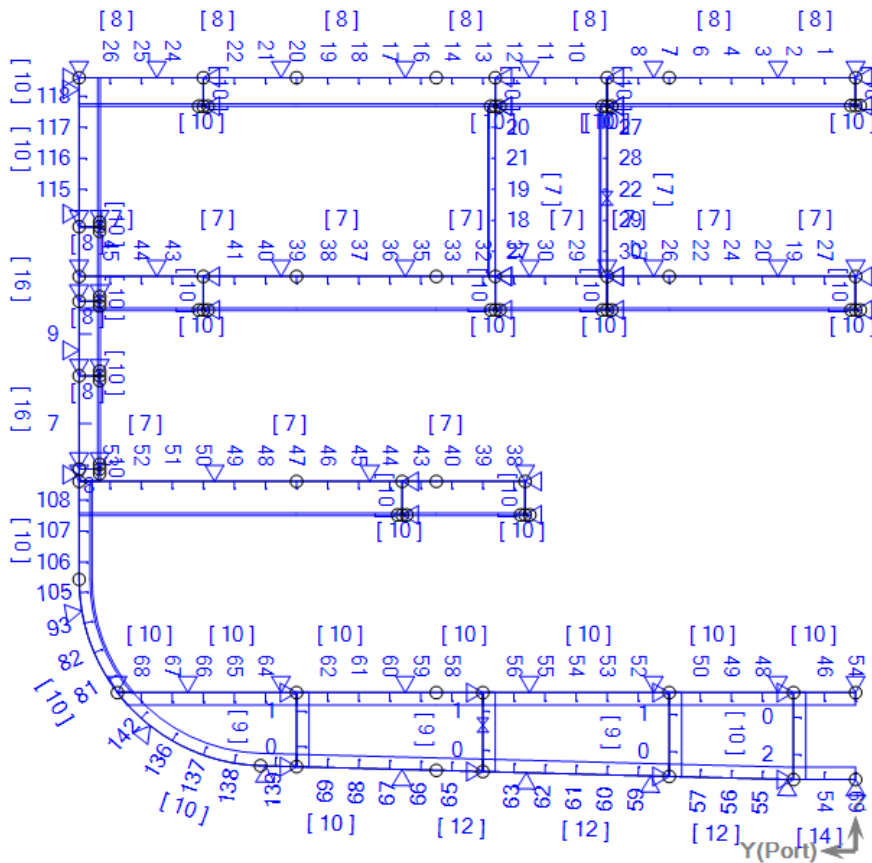

Slika 13. Prikaz geometrije presjeka okvirnog rebra

3.4. Analiza strukture

U Nauticus Hull-u analiza glavnog rebra se provodi pomoću naredbe „Run“. Prije provođenja analize potrebno je u izborniku odabrati po kojim pravilima će se provjeravati modelirana struktura kao što je prikazano slikom 14. „Prescriptive“ se odnosi na čvrstoću jakih nosača, lokalnih uvjeta čvrstoće za opločenje, uzdužnjake, poprečna ukrepljenja i rebra. „HULS“ obuhvaća provjeru granične čvrstoće trupa na savijanje. „Fatigue“ predstavlja procjenu spojeva uzdužnjanka na poprečne elemente.

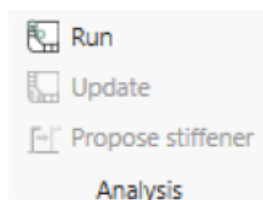

DNV rules

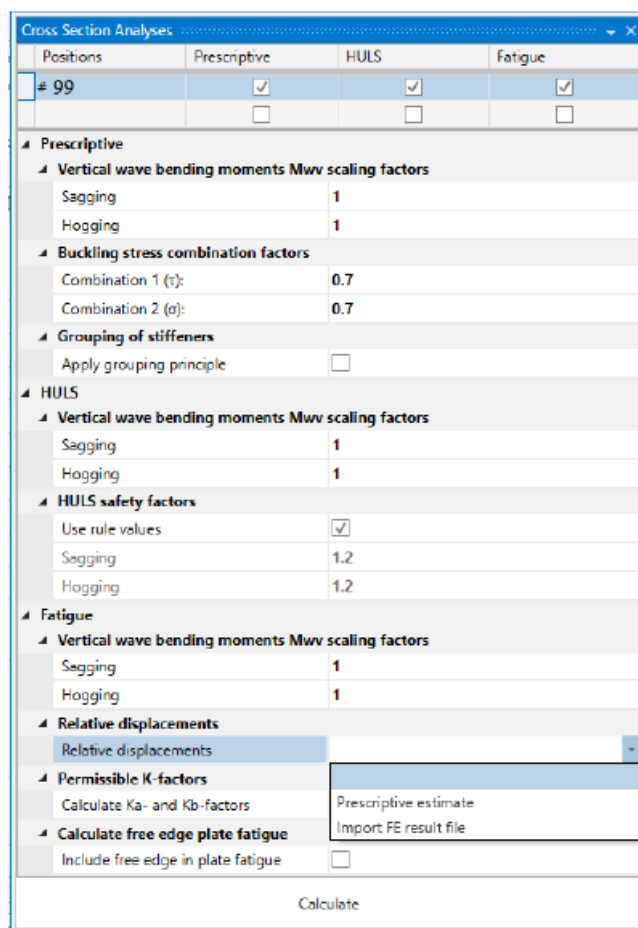

Slika 14. Izbornik pravila za provođenje strukturne analize

Rezultat strukturne analize vidljiv je u stablu rezultata koje se nalazi na krajnje desnoj strani korisničkog sučelja. U stablu je naznačena podjela po elementima strukture zadanog presjeka sa kvadratićima ispred pojma koji je obojan crvenom ili zelenom bojom ovisno o tome zadovoljavaju li elementi iste skupine sve uvjete za čvrstoću ili ne (Sika 15).

Ako neki od strukturnih elemenata ne zadovoljava sve uvjete čvrstoće potrebno ih je promijeniti. To je moguće iteracijskim putem jer postoji opcija kojom se odabranom ukrućenju mogu zasebno podesiti ključni parametri mjenjajući mu dimenzije i razmake između elemenata kako bi se provjerili lokalni zahtjevi. Analiza će se tako provesti samo za odabrano ukrućenje dok će sva naprezanja trupa broda i svi ostali rezultati ostati nepromijenjeni. Ovaj proces omogućava da se specifični djelovi strukture precizno prilagode i analiziraju bez utjecaja na ostatak strukture čime se olakšava optimizacija i održavanje sigurnosti broda. Proces iteracije potrebno je provoditi sve dok svi elementi ne zadovolje sve zahtjeve čvrstoće.

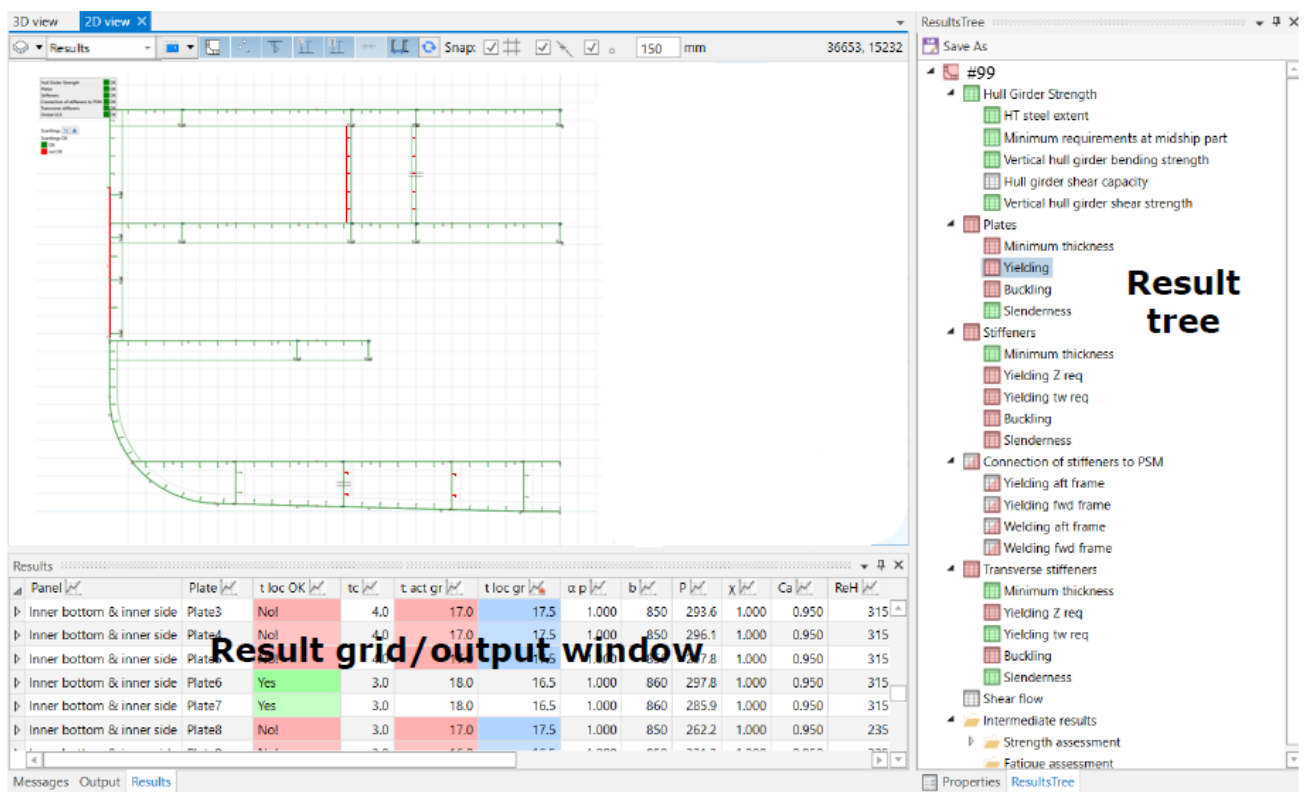

Slika 15. Korisničko sučelje nakon provedene analize

Kada je analiza provedena i svi elementi poprimu zelenu boju može se zaključiti da je predložena struktura zadovoljava uvjete proračuna. Tada će model presjeka paralelnog srednjaka koji se analizirao izgledati kao na Slici 16.

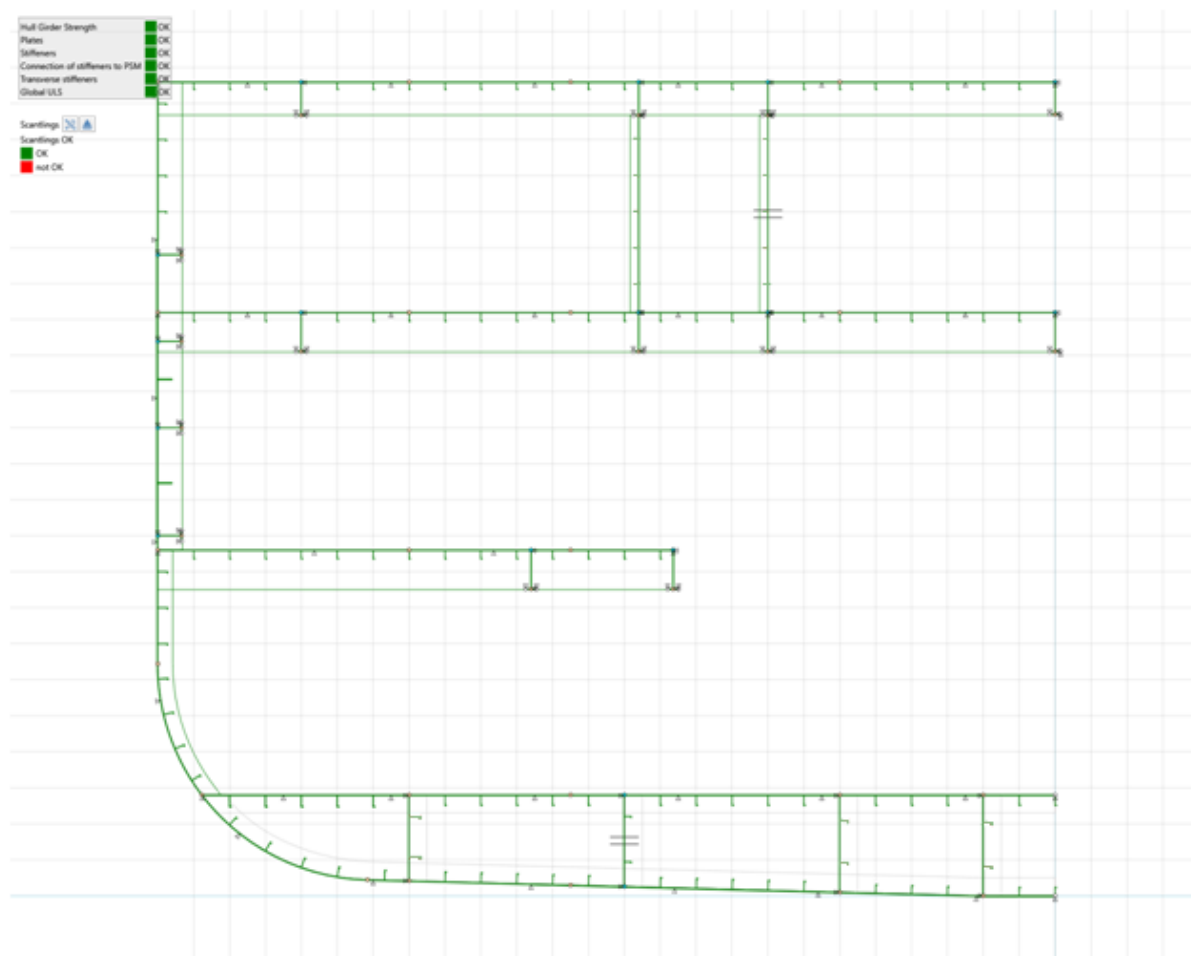

Slika 16. Prikaz usvojene strukture nakon analize

Rezultati proračuna strukture dobivaju se direktno iz Nauticus Hull-a u obliku izvještaja. U izvještaju su dani podatci o položaju poprečnih pregrada, podatci o rasporedu uzdužnih i poprečnih ukrepa poprečnog presjeka, sažetak težine, poglavlje s detaljnim zahtjevima za čvrstoću trupa broda i rezultate izračuna čvrstoće spojeva. Tablice sa strukturnim elementima koji ne zadovoljavaju kao i tablice za svu strukturu s fokusom na zahtjeve pravila klasifikacijskog društva.

Cross section analyses reports X

Prescriptive report ▾

#99

Summary All

Model input

- Positions of transverse bulkheads
- Deepest equilibrium waterline in damage condition
- Layout of plates and stiffeners
- End connections and slots/lugs
- Weight summary

Requirements

- Include summary plot
- Hull girder strength
- Structure below local requirements
- Local requirements
- Connection strength
- UR S11A
- Rule status plots

Compartments and loads

- Loading conditions
- Compartments
- Compartments for current cross-section only

Generate report

Slika 17. Izbornik za izradu izvještaja

3.5. Rezultati izdvojeni iz izvještaja

3.5.1. Poprečne pregrade

Tablica 7. Pozicije nepropusnih pregrada po duljini broda

OKVIR	Udaljenost od krmene okomice [m]
#8	9.910
#19	16.510
#35	26.110
#55	38.110
#70	47.110
#90	59.110
#112	72.310
#136	86.710
#152	96.310
#163	102.910
#177	111.310
#185	116.110

3.5.2. Materijali prema poziciji na presjeku

Tablica 8. Definicija materijala po poziciji na brodu

		Dno	Bok	Paluba	Iznad palube
Grupa materijala	-	VL-36	VL-36	VL-36	VL-36
Granica razvlačenja, R_{eH}	N/mm^2	355	355	355	355
Faktor materijala, k	-	0.72	0.72	0.72	0.72
Vertical extent, Z_{hts}	mm	6490		5402	

3.5.3. Sažetak procjene mase strukture trupa

Tablica 9. Mase elemenata structure

<u>UZDUŽNI LIMOV I UKREPE</u>			
Materijal	Strukturni element	Projektirana površina [cm ²]	Masa [t/m]
VL-36	Limovi	15645.8	12.38
VL-36	Ukrepe	2688.1	2.11
	% od ukupnog	100	100
Ukupno		18333.9	14.39
<u>POPREČNE UKREPE</u>			
Materijal	Masa [t]	%	
VL-36	4.09	100	
Ukupno	4.09	100	

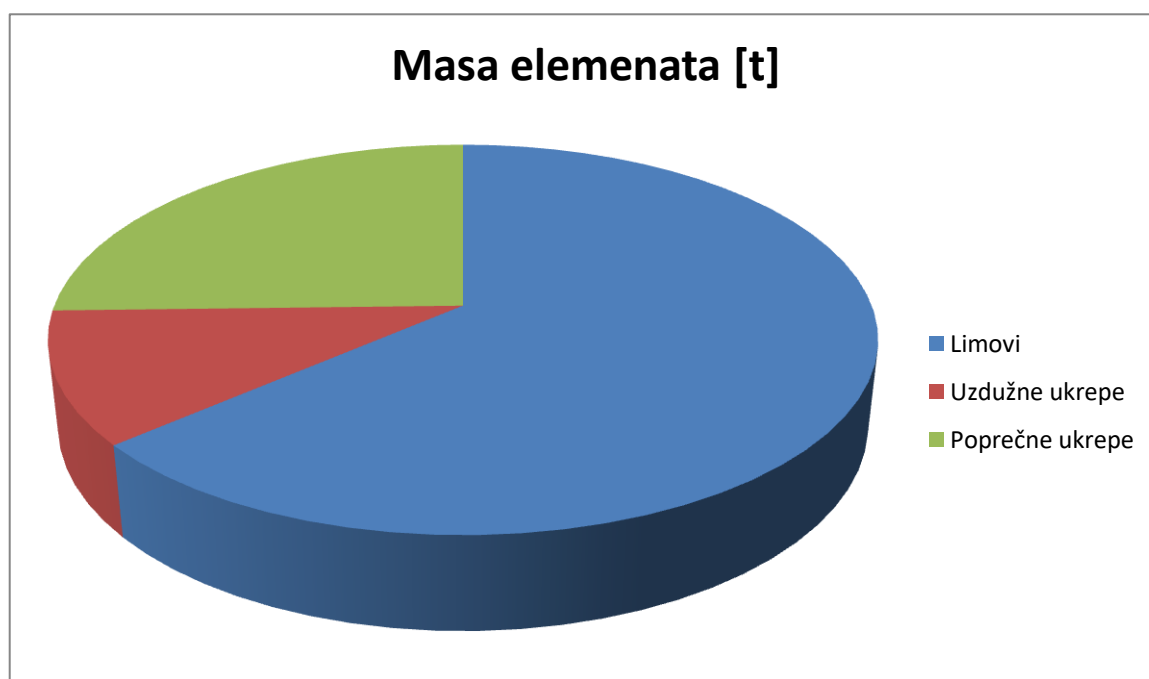

Slika 18. Dijagram udjela mase konstrukcijskih elemenata

Napomena: T nosači uvršteni su pod limove kao dva zasebna elementa.

3.5.4. Limovi poprečnog presjeka

Tablica 10. Dimenzije panela na brodu

Opločenje	Početak po Y-osi [mm]	Kraj po Y-osi [mm]	Početak po Z-osi [mm]	Kraj po Z-osi [mm]	Širina [mm]	Debljina [mm]	Površina [cm ²]	Granično naprezanje [N/mm ²]
-----------	-----------------------	--------------------	-----------------------	--------------------	-------------	---------------	-----------------------------	--

Vanjska oplata								
Plate0	0.0	1100.0	0.0	2.5	1100.0	14.0	154.0	355
Plate1	1100.0	3300.0	2.5	57.9	2200.0	12.0	264.1	355
Plate2	3300.0	5300.0	57.9	110.5	2000.0	12.0	240.1	355
Plate3	5300.0	7300.0	110.5	163.2	2000.0	12.0	240.1	355
Plate4	7300.0	9500.0	163.2	221.1	2200.0	10.0	220.1	355
Plate5	9500.0	11355.1	221.1	864.4	2000.0	10.0	200.0	355
Plate6	11355.1	12456.3	864.4	2712.2	2200.0	10.0	220.0	355
Plate7	12456.3	12500.0	2712.2	4909.7	2200.0	10.0	220.0	355
Plate8	12500.0	12500.0	4909.7	6909.7	2000.0	16.0	320.0	355
Plate9	12500.0	12500.0	6909.7	9109.7	2200.0	16.0	352.0	355
Plate10	12500.0	12500.0	9109.7	11109.7	2000.0	10.0	200.0	355
Plate11	12500.0	12500.0	11109.7	11300.0	190.3	10.0	19.0	355

Paluba čvrstoće								
Plate0	0.0	1250.0	11300.0	11300.0	1250.0	8.0	100.0	355
Plate1	1250.0	3250.0	11300.0	11300.0	2000.0	8.0	160.0	355
Plate2	3250.0	5250.0	11300.0	11300.0	2000.0	8.0	160.0	355
Plate3	5250.0	7250.0	11300.0	11300.0	2000.0	8.0	160.0	355
Plate4	7250.0	9250.0	11300.0	11300.0	2000.0	8.0	160.0	355
Plate5	9250.0	11250.0	11300.0	11300.0	2000.0	8.0	160.0	355
Plate6	11250.0	12500.0	11300.0	11300.0	1250.0	8.0	100.0	355

Paluba 4800								
Plate0	5320.0	7820.0	4800.0	4800.0	2500.0	7.0	175.0	355
Plate1	7820.0	10320.0	4800.0	4800.0	2500.0	7.0	175.0	355
Plate2	10320.0	12500.0	4800.0	4800.0	2180.0	7.0	152.6	355

Opločenje	Početak po Y-osi [mm]	Kraj po Y-osi [mm]	Početak po Z-osi [mm]	Kraj po Z-osi [mm]	Širina [mm]	Debljina [mm]	Površina [cm ²]	Granično naprežanje [N/mm ²]
<u>Paluba 8100</u>								
Plate0	0.0	1250.0	8100.0	8100.0	1250.0	7.0	87.5	355
Plate1	1250.0	3250.0	8100.0	8100.0	2000.0	7.0	140.0	355
Plate2	3250.0	4000.0	8100.0	8100.0	750.0	7.0	52.5	355
Plate3	4000.0	5250.0	8100.0	8100.0	1250.0	7.0	87.5	355
Plate4	5250.0	7250.0	8100.0	8100.0	2000.0	7.0	140.0	355
Plate5	7250.0	9250.0	8100.0	8100.0	2000.0	7.0	140.0	355
Plate6	9250.0	11250.0	8100.0	8100.0	2000.0	7.0	140.0	355
Plate7	11250.0	12500.0	8100.0	8100.0	1250.0	7.0	87.5	355

<u>Dvodono</u>								
Plate0	0.0	1250.0	1400.0	1400.0	1250.0	10.0	125.0	355
Plate1	1250.0	3250.0	1400.0	1400.0	2000.0	10.0	200.0	355
Plate2	3250.0	5250.0	1400.0	1400.0	2000.0	10.0	200.0	355
Plate3	5250.0	7250.0	1400.0	1400.0	2000.0	10.0	200.0	355
Plate4	7250.0	9250.0	1400.0	1400.0	2000.0	10.0	200.0	355
Plate5	9250.0	10750.0	1400.0	1400.0	1500.0	10.0	150.0	355
Plate6	10750.0	11883.3	1400.0	1400.0	1133.3	10.0	113.3	355

<u>Jaki uzdužni nosač 9000</u>								
Plate0	9000.0	9000.0	207.9	1400.0	1192.1	9.0	107.3	355
<u>Jaki uzdužni nosač 3000</u>								
Plate0	3000.0	3000.0	50.0	1400.0	1350.0	9.0	121.5	355

<u>Uzdužni nosač 6000</u>								
Plate0	6000.0	6000.0	128.9	1400.0	1271.1	9.0	114.4	355

<u>General Panel 2</u>								
Plate0	4000.0	4000.0	10840.0	8100.0	2740.0	7.0	191.8	355
<u>General Panel 3</u>								
Plate0	5800.0	5800.0	10840.0	8100.0	2740.0	7.0	191.8	355
<u>General Panel 4</u>								
Plate0	1000.0	1000.0	0.0	1400.0	1400.0	10.0	140.0	355

T nosači na boku broda – ICE BELT

Tablica 11. Dimenzije T nosača na boku broda

Oploč nje	Početak po Y-osi [mm]	Kraj po Y-osi [mm]	Početa k po Z- osi [mm]	Kraj po Z-osi [mm]	Širina [mm]	Deblji na [mm]	Površin a [cm²]	Granično naprezanj e [N/mm²]
Single-Skin Girder 4 Web								
Plate0	12500.0	12170.0	8900.0	8900.0	330. 0	8.0	26.4	355
Single-Skin Girder 4 Flange								
Plate0	12170.0	12170.0	8825.0	8975.0	150. 0	10.0	15.0	355
Single-Skin Girder 2 Web								
Plate0	12500.0	12170.0	7700.0	7700. 0	330.0	8.0	26.4	355
Single-Skin Girder 2 Flange								
Plate0	12170.0	12170.0	7625.0	7775. 0	150.0	10.0	15.0	355
Single-Skin Girder 0 Web								
Plate0	12500.0	12170.0	6500.0	6500. 0	330.0	8.0	26.4	355
Single-Skin Girder 0 Flange								
Plate0	12170.0	12170.0	6425.0	6575. 0	150.0	10.0	15.0	355
Single-Skin Girder 8 Web_2								
Plate0	12500.0	12170.0	5000.0	5000. 0	330.0	8.0	26.4	355
Single-Skin Girder 8 Flange_2								
Plate0	12170.0	12170.0	4925.0	5075. 0	150.0	10.0	15.0	355

T nosači na palubi (4800 mm)

Tablica 12. Dimenzije T nosača na palubi (z=4800 mm)

Opločenje	Početak po Y-osi [mm]	Kraj po Y-osi [mm]	Početak po Z-osi [mm]	Kraj po Z-osi [mm]	Širina [mm]	Debljina [mm]	Površina [cm²]	Granično naprezanje [N/mm²]
Single-Skin Girder 5 Web								
Plate0	7300.0	7300.0	4800.0	4260.0	540.0	10.0	54.0	355
Single-Skin Girder 5 Flange								
Plate0	7375.0	7225.0	4260.0	4260.0	150.0	10.0	15.0	355
Single-Skin Girder 10 Web								
Plate0	5320.0	5320.0	4800.0	4260.0	540.0	10.0	54.0	355
Single-Skin Girder 10 Flange								
Plate0	5395.0	5245.0	4260.0	4260.0	150.0	10.0	15.0	355

T nosači na palubi (8100 mm)

Tablica 13. Dimenzije T nosača na palubi (z=8100 mm)

Opločenje	Početak po Y-osi [mm]	Kraj po Y-osi [mm]	Početak po Z-osi [mm]	Kraj po Z-osi [mm]	Širina [mm]	Debljina [mm]	Površina [cm ²]	Grafično naprezanje [N/mm ²]
Single-Skin Girder 10 Web_2								
Plate0	10500.0	10500.0	8100.0	7560.0	540.0	10.0	54.0	355
Single-Skin Girder 10 Flange_2								
Plate0	10575.0	10425.0	7560.0	7560.0	150.0	10.0	15.0	355
Single-Skin Girder 10 Web_3								
Plate0	5800.0	5800.0	8100.0	7560.0	540.0	10.0	54.0	355
Single-Skin Girder 10 Flange_3								
Plate0	5875.0	5725.0	7560.0	7560.0	150.0	10.0	15.0	355
Single-Skin Girder 11 Web_2								
Plate0	4000.0	4000.0	8100.0	7560.0	540.0	10.0	54.0	355
Single-Skin Girder 11 Flange_2								
Plate0	4075.0	3925.0	7560.0	7560.0	150.0	10.0	15.0	355
Single-Skin Girder 13 Web								
Plate0	0.0	0.0	8100.0	7560.0	540.0	10.0	54.0	355
Single-Skin Girder 13 Flange								
Plate0	75.0	-75.0	7560.0	7560.0	150.0	10.0	15.0	355

T nosači na palubi čvrstoće (11300 mm)

Tablica 14. Dimenzije T nosača na palubi čvrstoće

Opločenje	Početak po Y-osi [mm]	Kraj po Y-osi [mm]	Početak po Z-osi [mm]	Kraj po Z-osi [mm]	Širina [mm]	Debljina [mm]	Površina [cm²]	Granično napreznje [N/mm²]
Single-Skin Girder 11 Web								
Plate0	10500.0	10500.0	11300.0	10840.0	460.0	10.0	46.0	355
Single-Skin Girder 11 Flange								
Plate0	10575.0	10425.0	10840.0	10840.0	150.0	10.0	15.0	355
Single-Skin Girder 8 Web_3								
Plate0	5800.0	5800.0	11300.0	10840.0	460.0	10.0	46.0	355
Single-Skin Girder 8 Flange_3								
Plate0	5875.0	5725.0	10840.0	10840.0	150.0	10.0	15.0	355
Single-Skin Girder 8 Web								
Plate0	4000.0	4000.0	11300.0	10840.0	460.0	10.0	46.0	355
Single-Skin Girder 8 Flange								
Plate0	4075.0	3925.0	10840.0	10840.0	75.0	10.0	7.5	355
Single-Skin Girder 12 Web								
Plate0	0.0	0.0	11300.0	10850.0	450.0	10.0	45.0	355
Single-Skin Girder 12 Flange								
Plate0	75.0	-75.0	10850.0	10850.0	150.0	10.0	15.0	355

3.5.5. Uzdužne ukrepe poprečnog presjeka

Tablica 15. Dimenzije uzdužnih ukrepa

ID Od - Do	Tip Profila	Dimenzije	Granično naprezanje [N/mm²]
<u>Vanjska oplata</u>			
69 - 57	HPBulb	120 x 7	355
59 - 108	HPBulb	140 x 7	355
7 - 9	Flatbar	200 x 15	355
115 - 118	HPBulb	120 x 7	355
<u>Paluba čvrstoće</u>			
1 - 26	HPBulb	100 x 7	355
<u>Paluba 4800</u>			
38 - 53	HPBulb	120 x 7	355
<u>Paluba 8100</u>			
27 - 45	HPBulb	120 x 7	355
<u>Dvodno</u>			
54 - 62	HPBulb	140 x 7	355
64 - 68	HPBulb	160 x 11	355
<u>Jaki uzdužni nosač 9000</u>			
0 - 1	HPBulb	160 x 8	355
<u>Jaki uzdužni nosač 3000</u>			
0 - 1	HPBulb	120 x 9	355
<u>Uzdužni nosač 6000</u>			
0 - 1	HPBulb	100 x 6	355
<u>General Panel 2</u>			
27 - 30	Flatbar	60 x 8	355
<u>General Panel 3</u>			
20 - 27	Flatbar	60 x 8	355
<u>General Panel 4</u>			
2 - 0	HPBulb	120 x 7	355

3.5.6.Rebra poprečnog presjeka

Tablica 16. Dimenzije rebara poprečnog presjeka

Tip	Vrsta Profila	Dimenzije	Raspon [mm]	Ramak [mm]	Granično naprezanje [N/mm²]
<u>Vanjska oplata</u>					
TSTIF	Built up T from plates	208 x 100 x 8 x 8	3465	600	355
TSTIF	Built up T from plates	339 x 100 x 9 x 9	200	600	355
TSTIF	Built up T from plates	339 x 100 x 9 x 9	3900	300	355
TSTIF	Built up T from plates	339 x 100 x 9 x 9	2400	600	355

3.5.7. Sponje poprečnog presjeka

Tablica 17. Dimenzije sponja porečnog presjeka

Tip	Vrsta Profila	Dimenzije	Raspon [mm]	Ramak [mm]	Granično naprezanje [N/mm²]
<u>Paluba čvrstoće</u>					
TSTIF	Built up T from plates	460 x 150 x 10 x 10	4000	600	355
TSTIF	Built up T from plates	460 x 150 x 10 x 10	1800	600	355
TSTIF	Built up T from plates	460 x 150 x 10 x 10	6700	600	355
<u>Paluba_4800</u>					
TSTIF	Built up T from plates	550 x 150 x 11 x 10	7180	600	355
<u>Paluba_8100</u>					
TSTIF	Built up T from plates	550 x 150 x 11 x 10	4000	600	355
TSTIF	Built up T from plates	550 x 150 x 11 x 10	1800	600	355
TSTIF	Built up T from plates	550 x 150 x 11 x 10	6700	600	355

3.5.8. Rebrenice

Tablica 18. Dimenzije rebrenica poprečnog presjeka

Tip	Vrsta Profila	Dimenzije	Raspon [mm]	Ramak [mm]	Granično naprezanje [N/mm ²]
<u>Dvodno</u>					
TGIRDER	Flatbar	150 x 10	3000	1800	355
TGIRDER	Flatbar	150 x 10	3000	1800	355
TGIRDER	Flatbar	150 x 10	3000	1800	355
TGIRDER	Flatbar	150 x 10	2883	1800	355
<u>Jaki uzdužni nosač 9000</u>					
TGIRDER	Flatbar	150 x 10	1192	1800	355
<u>Jaki uzdužni nosač 3000</u>					
TGIRDER	Flatbar	150 x 10	1350	1800	355
<u>Uzdužni nosač 6000</u>					
TGIRDER	Flatbar	150 x 10	1271	1800	355
<u>General Panel 2</u>					
TSTIF	HPBulb	120 x 7	2740	600	355
<u>General Panel 3</u>					
TSTIF	HPBulb	120 x 7	2740	600	355
<u>General Panel 4</u>					
TGIRDER	Flatbar	150 x 10	1400	1800	355

3.5.9. Napomene nakon proračuna

Nakon provedenog proračuna u izvještaju se ispisuju i napomene kojih se treba držati kako bi projektirana struktura zadovoljavala sva pravila. U analizi danog presjeka zaključuje se da je potrebno koristiti čelik povišene čvrstoće u području ledenog pojasa.

3.6. Provjera uzdužne čvrstoće

Minimalni moment inercije presjeka paralelnog srednjaka za sva plovila duljine veće od 90m računa se u m⁴ prema pravilima DNV-RU-SHIP Pt.3 Ch.5 Sec.2 [1.5]:

$$I_{yR-gr} = 3f_r C_w L^3 B (C_B + 0,7) 10^{-8} \quad (3.10.)$$

f_r = faktor odbitka vezan uz ograničenja službe = 1,0 (10% odbitka)

Moment otpora presjeka paluba računa se prema izrazu:

$$Z_{D-gr} = \frac{I_{y-gr}}{V_D} \quad (3.11.)$$

V_D = udaljenost do palube po z-osi, u m

Udaljenost do palube po z-osi, u m se računa prema:

$$V_D = Z_D - z_{n-gr} \quad (3.12.)$$

Z_D = Z koordinata u m, visine palube čvrstoće

z_{n-gr} = Z koordinata u m, na neutralnoj liniji poprečnog presjeka

Moment otpora presjeka dna računa se prema izrazu:

$$Z_{B-gr} = \frac{I_{y-gr}}{z_{n-gr}} \quad (3.13.)$$

Minimalni dozvoljen moment otpora presjeka paralelnog srednjaka pri ekvivalentnoj palubi i dnu ne smije biti manji od izračunatog u m³ prema izrazu:

$$Z_{R-gr} = k \left(\frac{1+f_r}{2} \right) C_{w0} L^2 B (C_B + 0,7) 10^{-6} \quad (3.14.)$$

Moment otpora presjeka povezan s dnom i palubom, duž pune duljine uzdužnjaka, od krmene do pramčane okomice, u m³ mora zadovoljavati iznos dobiven iz izraza prema DNV-RU-SHIP Pt.3 Ch.5. Sec.2 [1.4]:

$$Z_{gr} = \frac{|M_{sv} + M_{wv}|}{\sigma_{perm}} 10^{-3} \quad (3.15.)$$

gdje:

σ_{perm} = dopušteno naprezanje u N/mm² dobiveno prema:

$$\sigma_{perm} = \frac{125}{k} \quad \text{za } \frac{x}{L} \leq 0.1 \quad (3.16.1.)$$

$$\sigma_{perm} = \frac{175}{k} \quad \text{za } 0.3 \leq \frac{x}{L} \leq 0.7 \quad (3.16.2.)$$

$$\sigma_{perm} = \frac{125}{k} \quad \text{za } \frac{x}{L} \geq 0.9 \quad (3.16.3.)$$

3.6.1. Rezultat proračuna uzdužne čvrstoće

Tablica 19. Rezultati proračuna uzdužne čvrstoće

		Ukupno otvori zanemareni	
		projektirano	uz korozijski odbitak
Površina uzdužnih elemenata poprečnih presjeka	cm ²	18334	17205
Visina neutralne linije, Z _n	m	5.106	5.113
Vertikalni moment inercije, I _y	m ⁴	31.270	29.539
Horizontalni moment inercije, I _z	m ⁴	123.488	115.719
Moment otpora broda, Dno	m ³	6.125	5.777
Moment otpora broda, Paluba čvrstoće (z = 11300mm)	m ³	5.048	4.775
Moment otpora broda, Bok	m ³	9.879	9.258
Moment otpora površine iznad neutralne linije, S	m ³	3.449	3.253

Odabrane dimenzije strukturnih elemenata proizlaze iz proračuna čvrstoće koji provjerava dimenzije na postavljene zahtjeve. Proračun strukturnih elemenata kao i zahtjeva koje moraju zadovoljiti moguće je iščitati iz slijedećih tablica priloženih iz izvješća Nauticus Hull-a.

3.6.2.Provjera panela

Plate	Plate identification
ACT	Actual plate properties
t	Gross plate thickness [mm]
t _c	Corrosion addition [mm]
α _p	Correction factor for panel aspect ratio
C _a	Permissible bending stress coefficient
X	Coefficient
B. eff.	Bending effectiveness [%]
S. eff.	Shear effectiveness [%]
R _{eH}	Minimum yield stress for plate [N/mm ²]
LOC	Requirements due to local load and corresponding plate properties
Load ref.	Design Load Set, Load Case
EPP	EPP identification
t _{loc}	Required gross thickness of plate [mm]
t _{min}	Minimum gross thickness of plate [mm]
Span	Long side length of EPP [m]
Spac	Short side length of EPP [mm]
p	Lateral pressure [kN/m ²]
y _l	Y coordinate of LCP [mm]
z _l	Z coordinate of LCP [mm]
Draught	Draught [m]
σ _{hg}	Hull girder stress [N/mm ²]
F _{SC}	Steel coil load if decisive, i.e. BC-9 or BC-10 [kN]
OK?	Whether requirement(s) are fulfilled
BUC	Requirements due to buckling and corresponding plate properties
Load ref.	Design Load Set, Load Case
EPP	EPP identification
t _{s/t}	Minimum slenderness thickness requirement [mm]. Note: Slenderness requirement is based on proposed steel grade.

$t_{\text{buc}}^{1)}$	Minimum estimated local gross plate thickness to get $\eta_{\text{actual}} = \eta_{\text{allow}}$
Stress comb	Stress combination case, 1 or 2
Radius	Plate radius [mm]
σ_x	Applied σ_x [N/mm ²]
σ_y	Applied σ_y [N/mm ²]
τ	Applied Shear stress [N/mm ²]
σ_E	Reference stress [N/mm ²]
Asp. α	Aspect ratio
F_{long}	Correction factor
Case σ	Relevant case in Table 1 or 2
Case τ	Relevant case in Table 1 or 2
K_x	Buckling factor
K_y	Buckling factor
K_τ	Buckling factor
C_x	Reduction factor
C_y	Reduction factor
C_τ	Reduction factor
γ_c	Stress multiplier at collapse
η_{actual}	Eta actual
η_{allow}	Eta allowed
OK?	Whether requirement(s) are fulfilled
Note: 1)	Local scantling estimate without optimisation of the whole cross section

Plate	ACT		t [mm]	t _c [mm]	α _p	C _a	X		B. eff. [%]	S. eff. [%]	R _{eff} [N/mm ²]			
	LOC	Load ref.	EPP	t _{loc} [mm]	t _{min} [mm]	Span [mm]	Spac [mm]	p [kN/m ²]	y ₁ [mm]	z ₁ [mm]	Draught [m]	σ _{hg} [N/mm ²]	Fsc [kN]	OK?
	BUC	Load ref.	EPP	t _{s/t} t _{buc} [mm]	Stress comb. Radius [mm]	σ _x σ _y τ [N/mm ²]	σ _E [N/mm ²]	Asp. α F _{long}	Case σ Case τ	K _x K _y K _τ	C _x C _y C _τ	γ _c	η _{actual} η _{allow}	OK?

Frame #99 (64510 mm from A.P.)

Outer shell at #99

Plate0	ACT		14.0	1.5	1.00	1	0		100	100	355			
	LOC	SEA-2, Static	EPP1	0.0	11.5	1800.0	500.0	0.0	500	0	0.000	36.4		Yes
	BUC	HSM_2	EPP1	6.5 5.0	1 0	119.9 0.0 0.1	116.4	3.60 1.03	Case_1 Case_15	4.11 1.16 9.78	0.98 1.00 1.00	2.89	0.35 1.00	Yes
Plate1	ACT		12.0	1.5	1.00	1	0		100	100	355			
	LOC	TK-2, Static	EPP8	6.0	9.5	1800.0	500.2	145.6	3500	63	0.000	35.9		Yes
	BUC	HSM_2	EPP6	6.5 5.5	1 0	119.3 0.0 -6.5	82.1	3.60 1.05	Case_1 Case_15	4.19 1.16 9.78	0.87 1.00 1.00	2.57	0.39 1.00	Yes
Plate2	ACT		12.0	1.0	1.00	1	0		100	100	355			
	LOC	TK-2, Static	EPP9	6.0	9.0	1800.0	500.2	145.6	3500	63	0.000	35.9		Yes
	BUC	HSM_2	EPP13	6.0 5.0	1 0	117.5 0.0 -14.1	90.1	3.60 1.06	Case_1 Case_15	4.25 1.16 9.78	0.91 1.00 1.00	2.65	0.38 1.00	Yes
Plate3	ACT		12.0	1.0	1.00	1	0		100	100	355			
	LOC	TK-2, Static	EPP14	6.0	9.0	1800.0	500.2	145.1	5500	116	0.000	35.5		Yes
	BUC	HSM_2	EPP17	6.0 5.5	1 0	116.5 0.0 -17.1	90.1	3.60 1.07	Case_1 Case_15	4.29 1.16 9.78	0.91 1.00 1.00	2.64	0.38 1.00	Yes
Plate4	ACT		10.0	1.5	1.00	1	0		100	100	355			
	LOC	TK-2, Static	EPP19	6.0	9.5	1800.0	500.2	144.6	7500	168	0.000	35.2		Yes
	BUC	HSM_2	EPP24	8.0 7.0	1 3000	114.8 0.0 -27.6	30.7	2.72 1.09	Case_1 Case_15	4.36 1.29 10.19	0.60 1.00 0.79	1.66	0.60 1.00	Yes
Plate5	ACT		10.0	1.5	1.00	1	0		100	100	355			
	LOC	SEA-2, Static	EPP25	0.0	9.5	1800.0	662.1	0.0	9340	217	0.000	34.8		Yes
	BUC	HSM_2	EPP25	8.0 7.0	1 3000	114.8 0.0 -27.6	30.7	2.72 1.09	Case_1 Case_15	4.36 1.29 10.19	0.60 1.00 0.79	1.66	0.60 1.00	Yes
Plate6	ACT		10.0	1.5	1.00	1	0		100	100	355			
	LOC	SEA-2, Static	EPP29	0.0	9.5	1800.0	618.4	0.0	11000	624	0.000	31.9		Yes
	BUC	HSM_2	EPP32	7.5 7.5	2 3000	57.6 0.0 -99.6	53.8	1.20 1.09	Case_1 Case_15	4.62 2.87 14.06	0.78 1.00 1.00	1.78	0.56 1.00	Yes
Plate7	ACT		10.0	1.5	0.80	1	0		100	100	355			
	LOC	SEA-2, Static	EPP35	0.0	9.5	600.0	500.0	0.0	12416	2516	0.000	18.5		Yes
	BUC	HSM_2	EPP35	6.5 7.5	2 3000	42.6 0.0 -101.7	53.8	1.20 1.09	Case_1 Case_15	4.78 2.87 14.06	0.80 1.00 1.00	1.85	0.54 1.00	Yes
Plate8	ACT		16.0	1.5	0.00	0	0		100	100	355			
	LOC	Ice Class	EPP44	9.0	9.0	670.0	300.0	839.5	12500	6500	0.000	0.0		Yes
	BUC	HSM_1	EPP44	4.0 6.5	2 0	0.0 31.9 62.9	434.9	2.23 1.00	Case_2 Case_15	4.00 1.71 10.64	1.00 1.00 1.00	3.14	0.32 1.00	Yes
Plate9	ACT		16.0	1.5	0.00	0	0		100	100	355			
	LOC	Ice Class	EPP45	9.0	9.0	600.0	600.0	839.5	12500	8900	0.000	0.0		Yes
	BUC	HSM_2	EPP47	7.0 6.0	2 0	0.0 -45.7 -60.9	434.9	1.33 1.00	Case_12 Case_16	5.71 2.81 15.28	1.00 1.00 1.00	3.09	0.32 1.00	Yes
Plate10	ACT		10.0	1.0	0.72	1	0		100	100	355			
	LOC	SEA-2, Static	EPP50	0.0	8.5	600.0	600.0	0.0	12500	8900	0.000	-26.9		Yes
	BUC	HSM_1	EPP53	7.0 6.0	1 0	130.6 0.0 31.5	60.3	1.20 1.11	Case_1 Case_15	4.64 2.87 14.06	0.81 1.00 1.00	2.01	0.50 1.00	Yes

Plate	ACT		t [mm]	t _c [mm]	α _p	C _a	X		B. eff. [%]	S. eff. [%]	R _{eff} [N/mm ²]			
	LOC	Load ref.	EPP	t _{loc} [mm]	t _{min} [mm]	Span [mm]	Spac [mm]	p [kN/m ²]	y ₁ [mm]	z ₁ [mm]	Draught [m]	σ _{hg} [N/mm ²]	Fsc [kN]	OK?
	BUC	Load ref.	EPP	t _{s/t} t _{buc} [mm]	Stress comb. Radius [mm]	σ _x σ _y τ [N/mm ²]	σ _E [N/mm ²]	Asp. α F _{long}	Case σ Case τ	K _x K _y K _τ	C _x C _y C _τ	γ _c	η _{actual} η _{allow}	OK?
Plate11	ACT		10.0	1.0	0.96	1	0		100	100	355			
	LOC	SEA-2, Static	EPP55	0.0	8.5	600.0	300.0	0.0	12500	11000	0.000	-41.9		Yes
	BUC	HSM_1	EPP55	4.0 4.5	1	137.3 0.0 30.3	167.6	2.00 1.26	Case_1 Case_15	5.14 1.56 10.98	1.00 1.00 1.00	2.38	0.42 1.00	Yes

Strength Deck at #99

Plate0	ACT		8.0	1.0	0.80	1	0		100	100	355			
	LOC	UDL-2, Static	EPP56	1.0	6.5	600.0	500.0	3.4	500	11300	0.000	-44.0		Yes
	BUC	HSM_1	EPP58	6.0 5.0	1	137.3 0.0 -4.5	36.5	1.20 1.24	Case_1 Case_15	4.96 2.87 14.06	0.68 1.00 1.00	1.75	0.57 1.00	Yes
Plate1	ACT		8.0	1.0	0.80	1	0		100	100	355			
	LOC	UDL-2, Static	EPP59	1.0	6.5	600.0	500.0	3.4	1500	11300	0.000	-44.0		Yes
	BUC	HSM_1	EPP63	6.0 5.0	1	137.3 0.0 -10.9	36.5	1.20 1.24	Case_1 Case_15	4.96 2.87 14.06	0.68 1.00 1.00	1.73	0.58 1.00	Yes
Plate2	ACT		8.0	1.0	0.80	1	0		100	100	355			
	LOC	UDL-2, Static	EPP64	1.0	6.5	600.0	500.0	3.4	3500	11300	0.000	-44.0		Yes
	BUC	HSM_1	EPP68	6.0 5.5	1	137.3 0.0 -16.0	36.5	1.20 1.24	Case_1 Case_15	4.96 2.87 14.06	0.68 1.00 1.00	1.71	0.59 1.00	Yes
Plate3	ACT		8.0	1.0	0.80	1	0		100	100	355			
	LOC	UDL-2, Static	EPP69	1.0	6.5	600.0	500.0	3.4	5500	11300	0.000	-44.0		Yes
	BUC	HSM_1	EPP74	6.0 5.5	1	137.3 0.0 -19.6	36.5	1.20 1.24	Case_1 Case_15	4.96 2.87 14.06	0.68 1.00 1.00	1.69	0.59 1.00	Yes
Plate4	ACT		8.0	1.0	0.80	1	0		100	100	355			
	LOC	UDL-2, Static	EPP75	1.0	6.5	600.0	500.0	3.4	7500	11300	0.000	-44.0		Yes
	BUC	HSM_1	EPP79	6.0 5.5	1	137.3 0.0 -26.0	36.5	1.20 1.24	Case_1 Case_15	4.96 2.87 14.06	0.68 1.00 1.00	1.65	0.61 1.00	Yes
Plate5	ACT		8.0	1.0	0.80	1	0		100	100	355			
	LOC	UDL-2, Static	EPP80	1.0	6.5	600.0	500.0	3.4	9500	11300	0.000	-44.0		Yes
	BUC	HSM_1	EPP84	6.0 6.0	1	137.3 0.0 -34.0	36.5	1.20 1.24	Case_1 Case_15	4.96 2.87 14.06	0.68 1.00 1.00	1.60	0.62 1.00	Yes
Plate6	ACT		8.0	1.0	0.80	1	0		100	100	355			
	LOC	UDL-2, Static	EPP85	1.0	6.5	600.0	500.0	3.4	11500	11300	0.000	-44.0		Yes
	BUC	HSM_1	EPP86	6.0 6.0	1	137.3 0.0 -35.6	36.5	1.20 1.24	Case_1 Case_15	4.96 2.87 14.06	0.68 1.00 1.00	1.59	0.63 1.00	Yes

Deck_4800_4800 at #99

Plate0	ACT		7.0	1.4	0.80	1	0		100	100	355			
	LOC	UDL-2, Static	EPP89	1.5	7.0	600.0	500.0	7.8	6000	4800	0.000	2.2		Yes
	BUC	HSM_2	EPP94	3.5 2.4	1	7.3 0.0 -1.0	23.4	1.20 1.30	Case_1 Case_15	5.20 2.87 14.06	0.58 1.00 0.81	26.48	0.04 1.00	Yes
Plate1	ACT		7.0	1.4	0.80	1	0		100	100	355			
	LOC	UDL-2, Static	EPP95	1.5	7.0	600.0	500.0	7.8	8000	4800	0.000	2.2		Yes
	BUC	HSM_2	EPP100	3.5 2.4	1	7.3 0.0 -1.4	23.4	1.20 1.30	Case_1 Case_15	5.20 2.87 14.06	0.58 1.00 0.81	25.59	0.04 1.00	Yes
Plate2	ACT		7.0	1.4	0.80	1	0		100	100	355			
	LOC	UDL-2, Static	EPP101	1.5	7.0	600.0	500.0	7.8	10500	4800	0.000	2.2		Yes
	BUC	HSM_2	EPP104	3.5 2.4	1	7.3 0.0 -1.7	23.4	1.20 1.30	Case_1 Case_15	5.20 2.87 14.06	0.58 1.00 0.81	25.03	0.04 1.00	Yes

Deck_8100_8100 at #99

Plate	ACT		t [mm]	t _c [mm]	α _p	C _a	X		B. eff. [%]	S. eff. [%]	R _{eff} [N/mm ²]			
	LOC	Load ref.	EPP	t _{loc} [mm]	t _{min} [mm]	Span [mm]	Spac [mm]	p [kN/m ²]	y ₁ [mm]	z ₁ [mm]	Draught [m]	σ _{hg} [N/mm ²]	Fsc [kN]	OK?
	BUC	Load ref.	EPP	t _{s/t} t _{buc} [mm]	Stress comb. Radius [mm]	σ _x σ _y τ [N/mm ²]	σ _E [N/mm ²]	Asp. α F _{long}	Case σ Case τ	K _x K _y K _z	C _x C _y C _z	γ _c	η _{actual} η _{allow}	OK?
Plate0	ACT		7.0	1.0	0.80	1	0		100	100	355			
	LOC	UDL-2, Static	EPP106	0.5	6.5	600.0	500.0	2.5	500	8100	0.000	-21.2		Yes
	BUC	HSM_1	EPP108	3.5 3.0	1 0	66.3 0.0 -2.5	26.8	1.20 1.24	Case_1 Case_15	4.98 2.87 14.06	0.60 1.00 0.87	3.19	0.31 1.00	Yes
Plate1	ACT		7.0	1.0	0.80	1	0		100	100	355			
	LOC	UDL-2, Static	EPP109	0.5	6.5	600.0	500.0	2.5	1500	8100	0.000	-21.2		Yes
	BUC	HSM_1	EPP113	3.5 3.5	1 0	66.3 0.0 -5.7	26.8	1.20 1.24	Case_1 Case_15	4.98 2.87 14.06	0.60 1.00 0.87	3.13	0.32 1.00	Yes
Plate2	ACT		7.0	1.0	0.80	1	0		100	100	355			
	LOC	UDL-2, Static	EPP114	0.5	6.5	600.0	500.0	2.5	3500	8100	0.000	-21.2		Yes
	BUC	HSM_1	EPP114	3.5 3.5	1 0	66.3 0.0 -5.7	26.8	1.20 1.24	Case_1 Case_15	4.98 2.87 14.06	0.60 1.00 0.87	3.13	0.32 1.00	Yes
Plate3	ACT		7.0	1.0	0.80	1	0		100	100	355			
	LOC	UDL-2, Static	EPP116	0.5	6.5	600.0	500.0	2.5	4500	8100	0.000	-21.2		Yes
	BUC	HSM_1	EPP118	3.5 4.0	1 0	66.3 0.0 -18.6	26.8	1.20 1.24	Case_1 Case_15	4.98 2.87 14.06	0.60 1.00 0.87	2.83	0.35 1.00	Yes
Plate4	ACT		7.0	1.0	0.80	1	0		100	100	355			
	LOC	UDL-2, Static	EPP119	0.5	6.5	600.0	500.0	2.5	5500	8100	0.000	-21.2		Yes
	BUC	HSM_1	EPP124	3.5 4.5	1 0	66.3 0.0 -33.6	26.8	1.20 1.24	Case_1 Case_15	4.98 2.87 14.06	0.60 1.00 0.87	2.45	0.41 1.00	Yes
Plate5	ACT		7.0	1.0	0.80	1	0		100	100	355			
	LOC	UDL-2, Static	EPP125	0.5	6.5	600.0	500.0	2.5	7500	8100	0.000	-21.2		Yes
	BUC	HSM_1	EPP129	3.5 4.5	1 0	66.3 0.0 -36.9	26.8	1.20 1.24	Case_1 Case_15	4.98 2.87 14.06	0.60 1.00 0.87	2.38	0.42 1.00	Yes
Plate6	ACT		7.0	1.0	0.80	1	0		100	100	355			
	LOC	UDL-2, Static	EPP130	0.5	6.5	600.0	500.0	2.5	9500	8100	0.000	-21.2		Yes
	BUC	HSM_1	EPP134	3.5 5.0	2 0	46.4 0.0 -58.6	26.8	1.20 1.24	Case_1 Case_15	4.98 2.87 14.06	0.60 1.00 0.87	2.25	0.44 1.00	Yes
Plate7	ACT		7.0	1.0	0.80	1	0		100	100	355			
	LOC	UDL-2, Static	EPP135	0.5	6.5	600.0	500.0	2.5	11500	8100	0.000	-21.2		Yes
	BUC	HSM_1	EPP137	3.5 5.0	2 0	46.4 0.0 -60.9	26.8	1.20 1.32	Case_1 Case_15	5.29 2.87 14.06	0.61 1.00 0.87	2.21	0.45 1.00	Yes

Inner bottom at #99

Plate0	ACT		10.0	1.5	1.00	1	0		100	100	355			
	LOC	UDL-2, Static	EPP138	1.5	8.0	1800.0	500.0	7.8	500	1400	0.000	26.4		Yes
	BUC	HSM_2	EPP138	3.5 4.0	1 0	87.0 0.0 0.1	53.8	3.60 1.09	Case_1 Case_15	4.34 1.16 9.78	0.75 1.00 1.00	3.07	0.33 1.00	Yes
Plate1	ACT		10.0	1.5	1.00	1	0		100	100	355			
	LOC	TK-2, Static	EPP145	6.0	8.0	1800.0	500.0	132.2	3500	1400	0.000	26.4		Yes
	BUC	HSM_2	EPP143	5.0 4.5	1 0	87.0 0.0 -6.4	53.8	3.60 1.09	Case_1 Case_15	4.34 1.16 9.78	0.75 1.00 1.00	3.03	0.33 1.00	Yes
Plate2	ACT		10.0	1.0	1.00	1	0		100	100	355			
	LOC	TK-2, Static	EPP146	6.0	7.5	1800.0	500.0	132.2	3500	1400	0.000	26.4		Yes
	BUC	HSM_2	EPP150	5.0 4.5	1 0	87.0 0.0 -14.2	60.3	3.60 1.11	Case_1 Case_15	4.45 1.16 9.78	0.79 1.00 1.00	3.08	0.33 1.00	Yes
Plate3	ACT		10.0	1.0	1.00	1	0		100	100	355			
	LOC	TK-2, Static	EPP151	6.0	7.5	1800.0	500.0	132.2	5500	1400	0.000	26.4		Yes
	BUC	HSM_2	EPP155	5.0 5.0	1 0	87.0 0.0 -21.7	60.3	3.60 1.11	Case_1 Case_15	4.45 1.16 9.78	0.79 1.00 1.00	2.93	0.34 1.00	Yes

Plate	ACT		t [mm]	t _c [mm]	α _p	C _a	X		B. eff. [%]	S. eff. [%]	R _{eff} [N/mm ²]			
	LOC	Load ref.	EPP	t _{loc} [mm]	t _{min} [mm]	Span [mm]	Spac [mm]	p [kN/m ²]	y ₁ [mm]	z ₁ [mm]	Draught [m]	σ _{hg} [N/mm ²]	Fsc [kN]	OK?
	BUC	Load ref.	EPP	t _{s/t} t _{buc} [mm]	Stress comb. Radius [mm]	σ _x σ _y τ [N/mm ²]	σ _E [N/mm ²]	Asp. α F _{long}	Case σ Case τ	K _x K _y K _τ	C _x C _y C _τ	γ _c	η _{actual} η _{allow}	OK?
Plate4	ACT		10.0	1.5	1.00	1	0		100	100	355			
	LOC	TK-2, Static	EPP156	6.0	8.0	1800.0	500.0	132.2	7500	1400	0.000	26.4		Yes
	BUC	HSM_2	EPP160	5.0 6.0	1 0	87.0 0.0 -29.6	53.8	3.60 1.35	Case_1 Case_15	5.40 1.16 9.78	0.82 1.00 1.00	2.82	0.35 1.00	Yes
Plate5	ACT		10.0	1.5	1.00	1	0		100	100	355			
	LOC	UDL-2, Static	EPP161	1.5	8.0	1800.0	500.0	7.8	9500	1400	0.000	26.4		Yes
	BUC	HSM_2	EPP164	3.5 6.0	1 0	87.0 0.0 -33.0	53.8	3.60 1.30	Case_1 Case_15	5.20 1.16 9.78	0.81 1.00 1.00	2.71	0.37 1.00	Yes
Plate6	ACT		10.0	1.5	1.00	1	0		100	100	355			
	LOC	UDL-2, Static	EPP165	1.5	8.0	1800.0	500.0	7.8	11000	1400	0.000	26.4		Yes
	BUC	HSM_2	EPP166	3.5 6.0	1 0	87.0 0.0 -34.1	53.8	3.60 1.30	Case_1 Case_15	5.20 1.16 9.78	0.81 1.00 1.00	2.69	0.37 1.00	Yes

LongPlaneBulkhead9000_9000 Split1 at #99

Plate0	ACT		9.0	1.0	0.00	0	0		100	100	355			
	LOC	Sea chest, -	EPP169	9.0	7.5	1800.0	570.0	200.0	9000	530	7.200	0.0		Yes
	BUC	HSM_2	EPP169	6.5 4.5	1 0	107.4 0.0 -3.1	36.7	3.16 1.25	Case_1 Case_15	5.30 1.21 9.94	0.71 1.00 0.85	2.33	0.43 1.00	Yes

LongPlaneBulkhead3000_3000 Split1 at #99

Plate0	ACT		9.0	1.0	1.00	1	0		100	100	355			
	LOC	TK-2, Static	EPP172	7.0	7.5	1800.0	600.0	141.7	3000	450	0.000	33.2		Yes
	BUC	HSM_2	EPP172	7.0 4.5	1 0	109.3 0.0 -1.1	33.1	3.00 1.25	Case_1 Case_15	5.31 1.23 10.02	0.68 1.00 0.81	2.21	0.45 1.00	Yes

Girder6000 at #99

Plate0	ACT		9.0	0.5	1.00	1	0		100	100	355			
	LOC	INT-1, Static	EPP175	2.5	7.0	1800.0	630.0	12.0	6000	470	7.200	33.0		Yes
	BUC	HSM_2	EPP175	6.5 4.0	1 0	108.8 0.0 -2.3	33.9	2.86 1.08	Case_1 Case_15	4.62 1.26 10.10	0.65 1.00 0.82	2.11	0.47 1.00	Yes

General Panel 2 at #99

Plate0	ACT		7.0	0.5	0.00	0	0		100	100	0			
	LOC			0.0	5.0	0.0	0.0	0.0	0	0	0.000	0.0		
	BUC	HSM_1	EPP178	3.5 4.5	1 0	119.5 0.0 -4.7	31.5	1.20 1.00	Case_1 Case_15	4.18 2.87 14.06	0.60 1.00 0.94	1.78	0.56 1.00	Yes

General Panel 3 at #99

Plate0	ACT		7.0	0.5	0.00	0	0		100	100	0			
	LOC			0.0	6.0	0.0	0.0	0.0	0	0	0.000	0.0		
	BUC	HSM_1	EPP184	3.5 4.5	1 0	119.5 0.0 -6.6	31.5	1.20 1.00	Case_1 Case_15	4.18 2.87 14.06	0.60 1.00 0.94	1.77	0.57 1.00	Yes

General Panel 4 at #99

Plate0	ACT		10.0	1.5	0.00	0	0		100	100	0			
	LOC			0.0	7.0	0.0	0.0	0.0	0	0	0.000	0.0		
	BUC	HSM_2	EPP190	4.5 5.0	1 0	110.5 0.0 -0.9	37.4	3.00 1.09	Case_1 Case_15	4.62 1.23 10.02	0.68 1.00 0.86	2.17	0.46 1.00	Yes

Single-Skin Girder 0 Web at #99

Plate0	ACT		8.0	1.5	0.00	0	0		100	100	0			
	LOC			0.0	7.5	0.0	0.0	0.0	0	0	0.000	0.0		
	BUC	HSM_1	EPP192	5.0 2.5	1 0	30.8 0.0 0.2	72.2	5.45 1.40	Case_1 Case_15	5.60 1.07 9.48	0.92 1.00 1.00	10.64	0.09 1.00	Yes

Single-Skin Girder 0 Flange at #99

Plate	ACT		t [mm]	t _c [mm]	α _p	C _a	X		B. eff. [%]	S. eff. [%]	R _{eff} [N/mm ²]			
	LOC	Load ref.	EPP	t _{loc} [mm]	t _{min} [mm]	Span [mm]	Spac [mm]	p [kN/m ²]	y ₁ [mm]	z ₁ [mm]	Draught [m]	σ _{hg} [N/mm ²]	Fsc [kN]	OK?
	BUC	Load ref.	EPP	t _{s/t} t _{buc} [mm]	Stress comb. Radius [mm]	σ _x σ _y τ [N/mm ²]	σ _E [N/mm ²]	Asp. α F _{long}	Case σ Case τ	K _x K _y K _τ	C _x C _y C _τ	γ _c	η _{actual} η _{allow}	OK?
Plate0	ACT		10.0	1.5	0.00	0	0		100	100	0			
	LOC			0.0	7.5	0.0	0.0	0.0	0	0	0.000	0.0		
	BUC	HSM_2	EPP194	9.0 2.0	1	-32.5 0.0 0.0	2391.4	24.00 1.40	Case_1 Case_15	5.60 1.00 9.26	1.00 1.00 1.00	10.92	0.09 1.00	Yes

Single-Skin Girder 2 Web at #99

Plate0	ACT		8.0	1.5	0.00	0	0		100	100	0			
	LOC			0.0	7.5	0.0	0.0	0.0	0	0	0.000	0.0		
	BUC	HSM_1	EPP195	5.0 2.5	1	57.4 0.0 0.4	72.2	5.45 1.40	Case_1 Case_15	5.60 1.07 9.48	0.92 1.00 1.00	5.71	0.18 1.00	Yes

Single-Skin Girder 2 Flange at #99

Plate0	ACT		10.0	1.5	0.00	0	0		100	100	0			
	LOC			0.0	7.5	0.0	0.0	0.0	0	0	0.000	0.0		
	BUC	HSM_2	EPP197	9.0 2.0	1	-60.6 0.0 0.0	2391.4	24.00 1.40	Case_1 Case_15	5.60 1.00 9.26	1.00 1.00 1.00	5.85	0.17 1.00	Yes

Single-Skin Girder 4 Web at #99

Plate0	ACT		8.0	0.5	0.00	0	0		100	100	0			
	LOC			0.0	6.5	0.0	0.0	0.0	0	0	0.000	0.0		
	BUC	HSM_2	EPP198	4.5 1.0	1	-88.8 0.0 0.1	96.2	5.45 1.40	Case_1 Case_15	5.60 1.07 9.48	1.00 1.00 1.00	4.00	0.25 1.00	Yes

Single-Skin Girder 4 Flange at #99

Plate0	ACT		10.0	0.5	0.00	0	0		100	100	0			
	LOC			0.0	6.5	0.0	0.0	0.0	0	0	0.000	0.0		
	BUC	HSM_2	EPP200	8.0 1.0	1	-88.8 0.0 0.0	2987.2	24.00 1.40	Case_1 Case_15	5.60 1.00 9.26	1.00 1.00 1.00	4.00	0.25 1.00	Yes

Single-Skin Girder 5 Web at #99

Plate0	ACT		10.0	1.5	0.00	0	0		100	100	0			
	LOC			0.0	7.0	0.0	0.0	0.0	0	0	0.000	0.0		
	BUC	HSM_2	EPP201	8.0 2.5	1	20.0 0.0 0.1	46.1	3.33 1.40	Case_1 Case_15	8.02 1.19 9.87	0.95 1.00 0.95	16.93	0.06 1.00	Yes

Single-Skin Girder 5 Flange at #99

Plate0	ACT		10.0	1.5	0.00	0	0		100	100	0			
	LOC			0.0	7.0	0.0	0.0	0.0	0	0	0.000	0.0		
	BUC	HSM_2	EPP202	8.5 2.0	1	20.0 0.0 0.0	2391.4	24.00 1.40	Case_1 Case_15	5.60 1.00 9.26	1.00 1.00 1.00	17.75	0.06 1.00	Yes

Single-Skin Girder 8 Web at #99

Plate0	ACT		10.0	0.5	0.00	0	0		100	100	0			
	LOC			0.0	6.0	0.0	0.0	0.0	0	0	0.000	0.0		
	BUC	HSM_1	EPP204	5.0 4.0	1	137.3 0.0 -1.4	79.4	3.91 1.40	Case_1 Case_15	5.81 1.13 9.70	0.97 1.00 1.00	2.51	0.40 1.00	Yes

Single-Skin Girder 8 Flange at #99

Plate0	ACT		10.0	0.5	0.00	0	0		100	100	0			
	LOC			0.0	6.0	0.0	0.0	0.0	0	0	0.000	0.0		
	BUC	HSM_2	EPP205	7.0 1.0	1	-134.3 0.0 0.0	2987.2	24.00 1.40	Case_1 Case_15	5.60 1.00 9.26	1.00 1.00 1.00	2.64	0.38 1.00	Yes
Plate1	ACT		10.0	0.5	0.00	0	0		100	100	0			
	LOC			0.0	6.0	0.0	0.0	0.0	0	0	0.000	0.0		
	BUC	HSM_2	EPP206	7.0 1.0	1	-134.3 0.0 0.0	2987.2	24.00 1.40	Case_1 Case_15	5.60 1.00 9.26	1.00 1.00 1.00	2.64	0.38 1.00	Yes

Plate	ACT		t [mm]	t _c [mm]	α _p	C _a	X		B. eff. [%]	S. eff. [%]	R _{eff} [N/mm ²]			
	LOC	Load ref.	EPP	t _{loc} [mm]	t _{min} [mm]	Span [mm]	Spac [mm]	p [kN/m ²]	y ₁ [mm]	z ₁ [mm]	Draught [m]	σ _{hg} [N/mm ²]	Fsc [kN]	OK?
	BUC	Load ref.	EPP	t _{s/t} t _{buc} [mm]	Stress comb. Radius [mm]	σ _x σ _y τ [N/mm ²]	σ _E [N/mm ²]	Asp. α F _{long}	Case σ Case τ	K _x K _y K _τ	C _x C _y C _τ	γ _c	η _{actual} η _{allow}	OK?

Single-Skin Girder 8 Web_2 at #99

Plate0	ACT		8.0	1.5	0.00	0	0		100	100	0			
	LOC			0.0	8.0	0.0	0.0	0.0	0	0	0.000	0.0		
	BUC	HSM_2	EPP207	4.0 2.0	1 0	2.7 0.0 0.0	72.2	5.45 1.40	Case_1 Case_15	5.60 1.07 9.48	1.00 1.00 1.00	88.61	0.01 1.00	Yes

Single-Skin Girder 8 Flange_2 at #99

Plate0	ACT		10.0	1.5	0.00	0	0		100	100	0			
	LOC			0.0	8.0	0.0	0.0	0.0	0	0	0.000	0.0		
	BUC	HSM_2	EPP208	7.5 2.0	1 0	4.4 0.0 0.0	2391.4	24.00 1.40	Case_1 Case_15	6.91 1.00 9.26	1.00 1.00 1.00	53.28	0.02 1.00	Yes

Single-Skin Girder 8 Web_3 at #99

Plate0	ACT		10.0	0.5	0.00	0	0		100	100	0			
	LOC			0.0	6.0	0.0	0.0	0.0	0	0	0.000	0.0		
	BUC	HSM_1	EPP210	5.0 4.0	1 0	137.3 0.0 -2.7	79.4	3.91 1.40	Case_1 Case_15	5.81 1.13 9.70	0.97 1.00 1.00	2.51	0.40 1.00	Yes

Single-Skin Girder 8 Flange_3 at #99

Plate0	ACT		10.0	0.5	0.00	0	0		100	100	0			
	LOC			0.0	6.0	0.0	0.0	0.0	0	0	0.000	0.0		
	BUC	HSM_2	EPP211	7.0 1.0	1 0	-134.3 0.0 0.0	2987.2	24.00 1.40	Case_1 Case_15	5.60 1.00 9.26	1.00 1.00 1.00	2.64	0.38 1.00	Yes

Single-Skin Girder 10 Web at #99

Plate0	ACT		10.0	1.5	0.00	0	0		100	100	0			
	LOC			0.0	7.0	0.0	0.0	0.0	0	0	0.000	0.0		
	BUC	HSM_2	EPP213	8.0 2.5	1 0	20.0 0.0 0.1	46.1	3.33 1.40	Case_1 Case_15	8.02 1.19 9.87	0.95 1.00 0.95	16.93	0.06 1.00	Yes

Single-Skin Girder 10 Flange at #99

Plate0	ACT		10.0	1.5	0.00	0	0		100	100	0			
	LOC			0.0	7.0	0.0	0.0	0.0	0	0	0.000	0.0		
	BUC	HSM_2	EPP214	8.5 2.0	1 0	20.0 0.0 0.0	2391.4	24.00 1.40	Case_1 Case_15	5.60 1.00 9.26	1.00 1.00 1.00	17.75	0.06 1.00	Yes

Single-Skin Girder 10 Web_2 at #99

Plate0	ACT		10.0	1.5	0.00	0	0		100	100	0			
	LOC			0.0	7.0	0.0	0.0	0.0	0	0	0.000	0.0		
	BUC	HSM_1	EPP216	8.0 3.5	1 0	66.3 0.0 0.5	46.1	3.33 1.40	Case_1 Case_15	6.13 1.19 9.87	0.83 1.00 0.95	4.42	0.23 1.00	Yes

Single-Skin Girder 10 Flange_2 at #99

Plate0	ACT		10.0	1.5	0.00	0	0		100	100	0			
	LOC			0.0	7.0	0.0	0.0	0.0	0	0	0.000	0.0		
	BUC	HSM_2	EPP217	8.5 2.0	1 0	-57.4 0.0 0.0	2391.4	24.00 1.40	Case_1 Case_15	5.60 1.00 9.26	1.00 1.00 1.00	6.19	0.16 1.00	Yes

Single-Skin Girder 11 Web at #99

Plate0	ACT		10.0	0.5	0.00	0	0		100	100	0			
	LOC			0.0	6.0	0.0	0.0	0.0	0	0	0.000	0.0		
	BUC	HSM_1	EPP219	6.0 4.0	1 0	137.3 0.0 0.9	79.4	3.91 1.40	Case_1 Case_15	5.81 1.13 9.70	0.97 1.00 1.00	2.51	0.40 1.00	Yes

Single-Skin Girder 11 Flange at #99

Plate	ACT		t [mm]	t _c [mm]	α _p	C _a	X		B. eff. [%]	S. eff. [%]	R _{eff} [N/mm ²]			
	LOC	Load ref.	EPP	t _{loc} [mm]	t _{min} [mm]	Span [mm]	Spac [mm]	p [kN/m ²]	y ₁ [mm]	z ₁ [mm]	Draught [m]	σ _{hg} [N/mm ²]	F _{sc} [kN]	OK?
	BUC	Load ref.	EPP	t _{s/t} t _{buc} [mm]	Stress comb. Radius [mm]	σ _x σ _y τ [N/mm ²]	σ _E [N/mm ²]	Asp. α F _{long}	Case σ Case τ	K _x K _y K _τ	C _x C _y C _τ	γ _c	η _{actual} η _{allow}	OK?
Plate0	ACT		10.0	0.5	0.00	0	0		100	100	0			
	LOC			0.0	6.0	0.0	0.0	0.0	0	0	0.000	0.0		
Provjera panela	BUC	HSM_2	EPP220	7.5 1.0	1	-134.3 0.0 0.0	2987.2	24.00 1.40	Case_1 Case_15	5.60 1.00 9.26	1.00 1.00 1.00	2.64	0.38 1.00	Yes

Single-Skin Girder 10 Web_3 at #99

Plate0	ACT		10.0	1.5	0.00	0	0		100	100	0			
	LOC			0.0	7.0	0.0	0.0	0.0	0	0	0.000	0.0		
	BUC	HSM_1	EPP222	8.0 3.5	1	66.3 0.0 0.5	46.1	3.33 1.40	Case_1 Case_15	6.13 1.19 9.87	0.83 1.00 0.95	4.42	0.23 1.00	Yes

Single-Skin Girder 10 Flange_3 at #99

Plate0	ACT		10.0	1.5	0.00	0	0		100	100	0			
	LOC			0.0	7.0	0.0	0.0	0.0	0	0	0.000	0.0		
	BUC	HSM_2	EPP223	8.5 2.0	1	-57.4 0.0 0.0	2391.4	24.00 1.40	Case_1 Case_15	5.60 1.00 9.26	1.00 1.00 1.00	6.19	0.16 1.00	Yes

Single-Skin Girder 11 Web_2 at #99

Plate0	ACT		10.0	1.5	0.00	0	0		100	100	0			
	LOC			0.0	7.0	0.0	0.0	0.0	0	0	0.000	0.0		
	BUC	HSM_1	EPP225	8.0 3.5	1	66.3 0.0 0.5	46.1	3.33 1.40	Case_1 Case_15	6.13 1.19 9.87	0.83 1.00 0.95	4.42	0.23 1.00	Yes

Single-Skin Girder 11 Flange_2 at #99

Plate0	ACT		10.0	1.5	0.00	0	0		100	100	0			
	LOC			0.0	7.0	0.0	0.0	0.0	0	0	0.000	0.0		
	BUC	HSM_2	EPP226	8.5 2.0	1	-57.4 0.0 0.0	2391.4	24.00 1.40	Case_1 Case_15	5.60 1.00 9.26	1.00 1.00 1.00	6.19	0.16 1.00	Yes

Single-Skin Girder 12 Web at #99

Plate0	ACT		10.0	0.5	0.00	0	0		100	100	0			
	LOC			0.0	6.0	0.0	0.0	0.0	0	0	0.000	0.0		
	BUC	HSM_1	EPP228	6.0 4.0	1	137.3 0.0 0.5	83.0	4.00 1.40	Case_1 Case_15	5.80 1.13 9.68	0.99 1.00 1.00	2.55	0.39 1.00	Yes

Single-Skin Girder 12 Flange at #99

Plate0	ACT		10.0	0.5	0.00	0	0		100	100	0			
	LOC			0.0	6.0	0.0	0.0	0.0	0	0	0.000	0.0		
	BUC	HSM_2	EPP229	7.5 1.0	1	-134.5 0.0 0.0	2987.2	24.00 1.40	Case_1 Case_15	5.60 1.00 9.26	1.00 1.00 1.00	2.64	0.38 1.00	Yes

Single-Skin Girder 13 Web at #99

Plate0	ACT		10.0	1.5	0.00	0	0		100	100	0			
	LOC			0.0	7.0	0.0	0.0	0.0	0	0	0.000	0.0		
	BUC	HSM_1	EPP231	8.0 3.5	1	66.3 0.0 0.2	46.1	3.33 1.40	Case_1 Case_15	6.13 1.19 9.87	0.83 1.00 0.95	4.42	0.23 1.00	Yes

Single-Skin Girder 13 Flange at #99

Plate0	ACT		10.0	1.5	0.00	0	0		100	100	0			
	LOC			0.0	7.0	0.0	0.0	0.0	0	0	0.000	0.0		
	BUC	HSM_2	EPP232	8.5 2.0	1	-57.4 0.0 0.0	2391.4	24.00 1.40	Case_1 Case_15	5.60 1.00 9.26	1.00 1.00 1.00	6.19	0.16 1.00	Yes

3.6.3. Provjera uzdužnjaka

Plate	Identifikacija opločenja
ACT	Stvarne dimenzije opločenja
t	Ukupna debljina opločenja [mm]
t_c	Dodatak za koroziju [mm]
α_p	Korekcijski faktor
C_a	Koeficijent dopuštenog
X	Koeficijent
B. eff.	Efektivnost savijanja [%]
S. eff.	Efektivnost smicanja [%]
R_{eH}	Granica ravlačenja [N/mm ²]
LOC	Zahtjevi za lokalnu čvrstoću
Load ref.	Projektno opterećenje
EPP	EPP identifikacija
t_{loc}	Zahtjevana debljina [mm]
t_{min}	Minimalna debljina [mm]
Span	Raspon [m]
Spac	Razmak [mm]
p	Bočni pritisak [kN/m ²]
y_1	Y koordinata LCP-a [mm]
z_1	Z koordinata LCP-a [mm]
Draught	Gazt [m]
σ_{hg}	Naprezanje jakog nosača [N/mm ²]
F_{SC}	Opterećenje čeličnih vitla [kN]
OK?	Jesu li zahtjevi ispunjeni
BUC	Zaktjevi zbog uvijanja
$t_{s/t}$	Minimalni zahtjevi za odnos debljine i dužine [mm].
$t_{buc}^{1)}$	Minimalna procjena debljine ploče da bi bilo $\eta_{actual} = \eta_{allow}$
Stress comb	Slučaj kombinacije naprezanja, 1 or 2
Radius	Radijus [mm]
σ_x	Primjenjeno σ_x [N/mm ²]
σ_y	Primjenjeno σ_y [N/mm ²]
τ	Primjenjeno smično naprezanje [N/mm ²]

σ_E	Referentno naprezanje [N/mm ²]
Asp. α	Odnos dimenzija
F_{long}	Korekcijski faktor
Case σ	Relevantni slučaj 1 or 2
Case τ	Relevantni slučaj 1 or 2
K_x	Faktor uvijanja
K_y	Faktor uvijanja
K_τ	Faktor uvijanja
C_x	Redukcijski faktor
C_y	Redukcijski faktor
C_τ	Redukcijski faktor
γ_c	Koeficijent naprezanja pri kolapsu
η_{actual}	Eta stvarno
η_{allow}	Eta dopušteno

Stiff. No	ACT	Type Dimension	y z [mm]	Z _{net} [cm ³]	Spacing t _{pl,net} [mm]	R _{eH} τ _{eH} [N/mm ²]	t _{ew} t _{ef} [mm]	h _{w,net} b _r [mm]	t _w t _r [mm]	X C _m	C _s C _t	l _{bdg} l _{shr} [mm]	
Group	LOC MIN	Load ref. for Z	Load ref. for t _w	Z _{req} [cm ³]	Z _{Rel,req} [%]	t _{w,min} t _{r,min} [mm]	t _{w,shear} t _{pl,min,net} [mm]	draught _z draught _{t_w} [m]	P _z F _{sc} [kN/m ²]	P _w [kN/m ²]	OK?		
BCU SLN		Span b _{ef} [mm]	Est. Z _{req} [cm ³]	Est. h _{w,req} Est. t _{r,req} [mm]	b _{r,sl} [mm]	I _{buc} I _{req} [cm ⁴]	t _{w,min,sl} t _{r,min,sl} [mm]	P _{lat} [kN/m ²]	σ _x σ _y [N/mm ²]	σ _a σ _b [N/mm ²]	τ σ _w [N/mm ²]	η _{actual} η _{allow}	OK?
Frame #99 (64510 mm from A.P.)													
Outer shell at #99													
69	ACT	HPBulb 120 x 7	0	50.64	500.0	355	1.4	120.0	7.0	0.00	0.850	1800	
	LOC MIN	SEA-2, Static	SEA-2, Static		0.00	0	7.0	0.0	0.000	0.000	0.0	0.0	Yes
BCU SLN		1800.0 363.0	0.0	0.0	0.0	576 8	4.0	0	120 0	122 108	0 2	0.50 1.00	Yes
54	ACT	HPBulb 120 x 7	500	50.64	500.0	355	1.4	120.0	7.0	0.00	0.850	1800	
	LOC MIN	SEA-2, Static	SEA-2, Static		0.00	0	7.0	0.0	0.000	0.000	0.0	0.0	Yes
BCU SLN		1800.0 363.0	0.0	0.0	0.0	576 8	4.0	0	120 0	121 109	0 2	0.50 1.00	Yes
55	ACT	HPBulb 120 x 7	1500	49.51	500.2	355	1.4	120.0	7.0	0.00	0.850	1800	
	LOC MIN	SEA-2, Static	SEA-2, Static		0.00	0	7.0	0.0	0.000	0.000	0.0	0.0	Yes
BCU SLN		1800.0 363.0	0.0	0.0	0.0	549 5	4.0	0	120 0	129 90	1 2	0.49 1.00	Yes
56	ACT	HPBulb 120 x 7	2000	49.51	500.2	355	1.4	120.0	7.0	0.00	0.850	1800	
	LOC MIN	SEA-2, Static	SEA-2, Static		0.00	0	7.0	0.0	0.000	0.000	0.0	0.0	Yes
BCU SLN		1800.0 363.0	0.0	0.0	0.0	549 5	4.0	0	119 0	134 87	-6 2	0.50 1.00	Yes
57	ACT	HPBulb 120 x 7	2500	49.51	500.2	355	1.4	120.0	7.0	0.00	0.850	1800	
	LOC MIN	SEA-2, Static	SEA-2, Static		0.00	0	7.0	0.0	0.000	0.000	0.0	0.0	Yes
BCU SLN		1800.0 363.0	0.0	0.0	0.0	549 5	4.0	0	119 0	131 89	-7 2	0.49 1.00	Yes
59	ACT	HPBulb 140 x 7	3500	75.95	500.2	355	0.5	140.3	7.0	0.00	1.000	1800	
	LOC MIN	TK-2, Static	TK-2, Static		57.06	133	6.0	2.5	0.000	0.000	-145.6	-145.6	Yes
BCU SLN		1800.0 363.0	0.0	0.0	0.0	954 6	4.5	-13	118 0	126 71	-10 3	0.45 1.00	Yes
60	ACT	HPBulb 140 x 7	4000	75.95	500.2	355	0.5	140.3	7.0	0.00	1.000	1800	
	LOC MIN	TK-2, Static	TK-2, Static		57.01	133	6.0	2.5	0.000	0.000	-145.5	-145.5	Yes
BCU SLN		1800.0 363.0	0.0	0.0	0.0	954 6	4.5	-13	118 0	128 69	-11 3	0.45 1.00	Yes
61	ACT	HPBulb 140 x 7	4500	75.95	500.2	355	0.5	140.3	7.0	0.00	1.000	1800	
	LOC MIN	TK-2, Static	TK-2, Static		56.96	133	6.0	2.5	0.000	0.000	-145.4	-145.4	Yes
BCU SLN		1800.0 363.0	0.0	0.0	0.0	954 6	4.5	-13	118 0	128 69	-12 3	0.45 1.00	Yes
62	ACT	HPBulb 140 x 7	5000	75.95	500.2	355	0.5	140.3	7.0	0.00	1.000	1800	
	LOC MIN	TK-2, Static	TK-2, Static		56.91	133	6.0	2.5	0.000	0.000	-145.2	-145.2	Yes
BCU SLN		1800.0 363.0	0.0	0.0	0.0	954 6	4.5	-13	117 0	127 69	-14 3	0.45 1.00	Yes
63	ACT	HPBulb 140 x 7	5500	75.95	500.2	355	0.5	140.3	7.0	0.00	1.000	1800	
	LOC MIN	TK-2, Static	TK-2, Static		56.85	134	6.0	2.0	0.000	0.000	-145.1	-145.1	Yes
BCU SLN		1800.0 363.0	0.0	0.0	0.0	954 6	4.5	-13	117 0	124 71	-15 3	0.44 1.00	Yes
65	ACT	HPBulb 140 x 7	6500	75.95	500.2	355	0.5	140.3	7.0	0.00	1.000	1800	
					11.0	205	0.5	0.0	0.0	0.00	0.950	1425	

	LOC MIN	TK-2, Static		TK-2, Static		56.75	134	6.0	2.0	0.000	0.000	-144.8	-144.8	Yes
BUC SLN		1800.0	0.0	0.0	0.0	954		4.5	-13	117	124	-17	0.44	Yes
		363.0		0.0		6		0.0		0	71	3	1.00	
66	ACT	HPBulb 140 x 7		7000	75.95	500.2	355	0.5	140.3	7.0	0.00	1.000	1800	
				155		11.0	205	0.5	0.0	0.0	1.000	0.950	1550	
	LOC MIN	TK-2, Static		TK-2, Static		56.70	134	6.0	2.5	0.000	0.000	-144.7	-144.7	Yes
BUC SLN		1800.0	0.0	0.0	0.0	929		4.5	-13	116	126	-20	0.44	Yes
		363.0		0.0		4		0.0		0	66	3	1.00	
67	ACT	HPBulb 140 x 7		7500	73.76	500.2	355	0.5	140.3	7.0	0.00	1.000	1800	
				168		8.5	205	0.5	0.0	0.0	1.000	0.950	1550	
	LOC MIN	TK-2, Static		TK-2, Static		56.65	130	6.0	2.5	0.000	0.000	-144.6	-144.6	Yes
BUC SLN		1800.0	0.0	0.0	0.0	902		4.5	-12	116	132	-24	0.45	Yes
		363.0		0.0		3		0.0		0	60	3	1.00	
68	ACT	HPBulb 140 x 7		8000	73.76	500.2	355	0.5	140.3	7.0	0.00	1.000	1800	
				182		8.5	205	0.5	0.0	0.0	1.000	0.950	1550	
	LOC MIN	TK-2, Static		TK-2, Static		56.60	130	6.0	2.5	0.000	0.000	-144.4	-144.4	Yes
BUC SLN		1800.0	0.0	0.0	0.0	902		4.5	-12	116	138	-25	0.47	Yes
		363.0		0.0		3		0.0		0	58	3	1.00	
69	ACT	HPBulb 140 x 7		8500	73.76	500.2	355	0.5	140.3	7.0	0.00	1.000	1800	
				195		8.5	205	0.5	0.0	0.0	1.000	0.950	1550	
	LOC MIN	TK-2, Static		TK-2, Static		56.54	130	6.0	2.5	0.000	0.000	-144.3	-144.3	Yes
BUC SLN		1800.0	0.0	0.0	0.0	902		4.5	-12	115	135	-26	0.46	Yes
		363.0		0.0		3		0.0		0	59	3	1.00	
139	ACT	HPBulb 140 x 7		9340	66.81	501.3	355	1.4	140.0	7.0	0.00	0.850	1800	
				217		8.5	205	1.5	0.0	0.0	1.000	0.750	1549	
	LOC MIN	SEA-2, Static		SEA-2, Static		0.00	0	7.0	0.0	0.000	0.000	0.0	0.0	Yes
BUC SLN		1800.0	0.0	0.0	0.0	816		5.0	0	115	146	-27	0.48	Yes
		363.4		0.0		3		0.0		0	48	4	1.00	
138	ACT	HPBulb 140 x 7		10000	66.81	589.6	355	1.4	140.0	7.0	0.00	0.850	1800	
				264		8.5	205	1.5	0.0	0.0	1.000	0.750	1505	
	LOC MIN	SEA-2, Static		SEA-2, Static		0.00	0	7.0	0.0	0.000	0.000	0.0	0.0	Yes
BUC SLN		1800.0	0.0	0.0	0.0	825		5.0	0	114	158	-29	0.52	Yes
		386.9		0.0		3		0.0		0	50	4	1.00	
137	ACT	HPBulb 140 x 7		10500	66.81	534.2	355	1.4	140.0	7.0	0.00	0.850	1800	
				394		8.5	205	1.5	0.0	0.0	1.000	0.750	1533	
	LOC MIN	SEA-2, Static		SEA-2, Static		0.00	0	7.0	0.0	0.000	0.000	0.0	0.0	Yes
BUC SLN		1800.0	0.0	0.0	0.0	820		5.0	0	111	143	-30	0.47	Yes
		373.1		0.0		3		0.0		0	50	4	1.00	
136	ACT	HPBulb 140 x 7		11000	66.81	584.8	355	1.4	140.0	7.0	0.00	0.850	1800	
				624		8.5	205	1.5	0.0	0.0	1.000	0.750	1508	
	LOC MIN	SEA-2, Static		SEA-2, Static		0.00	0	7.0	0.0	0.000	0.000	0.0	0.0	Yes
BUC SLN		1800.0	0.0	0.0	0.0	825		5.0	0	105	144	-31	0.48	Yes
		385.9		0.0		3		0.0		0	51	4	1.00	
142	ACT	HPBulb 140 x 7		11500	66.81	591.7	355	1.4	140.0	7.0	0.00	0.850	1800	
				986		8.5	205	1.5	0.0	0.0	1.000	0.750	1504	
	LOC MIN	SEA-2, Static		SEA-2, Static		0.00	0	7.0	0.0	0.000	0.000	0.0	0.0	Yes
BUC SLN		1800.0	0.0	0.0	0.0	825		5.0	0	97	130	-32	0.44	Yes
		387.4		0.0		3		0.0		0	54	4	1.00	
81	ACT	HPBulb 140 x 7		12024	66.81	372.8	355	1.4	140.0	7.0	0.00	0.850	1800	
				1601		8.5	205	1.5	0.0	0.0	1.000	0.750	1614	
	LOC MIN	SEA-2, Static		SEA-2, Static		0.00	0	7.0	0.0	0.000	0.000	0.0	0.0	Yes
BUC SLN		1800.0	0.0	0.0	0.0	791		5.0	0	82	93	-69	0.32	Yes
		311.8		0.0		2		0.0		0	62	3	1.00	
82	ACT	HPBulb 140 x 7		12258	66.81	500.0	355	1.4	140.0	7.0	0.00	0.850	1800	
				2042		8.5	205	1.5	0.0	0.0	1.000	0.750	1550	
	LOC MIN	SEA-2, Static		SEA-2, Static		0.00	0	7.0	0.0	0.000	0.000	0.0	0.0	Yes
BUC SLN		1800.0	0.0	0.0	0.0	815		5.0	0	72	87	-70	0.32	Yes
		363.0		0.0		3		0.0		0	79	3	1.00	
93	ACT	HPBulb 140 x 7		12416	66.81	500.0	355	1.4	140.0	7.0	0.00	0.850	1800	
				2516		8.5	205	1.5	0.0	0.0	1.000	0.750	1550	

	LOC MIN	SEA-2, Static		SEA-2, Static		0.00	0	7.0	0.0	0.000	0.000	0.0	0.0	Yes
BUC SLN		1800.0	0.0	0.0	0.0	815		5.0	0	61	73	-71	0.28	Yes
		363.0		0.0		3		0.0	0	0	88	3	1.00	
105	ACT	HPBulb 140 x 7		12492	66.81	495.2	355	1.4	140.0	7.0	0.00	0.850	1800	
				3010		8.5	205	1.5	0.0	0.0	1.000	0.750	1552	
	LOC MIN	SEA-2, Static		SEA-2, Static		0.00	0	7.0	0.0	0.000	0.000	0.0	0.0	Yes
BUC SLN		1800.0	0.0	0.0	0.0	815		5.0	0	49	58	-72	0.23	Yes
		361.5		0.0		3		0.0	0	0	103	3	1.00	
106	ACT	HPBulb 140 x 7		12500	66.81	495.2	355	1.4	140.0	7.0	0.00	0.850	1800	
				3500		8.5	205	1.5	0.0	0.0	1.000	0.750	1552	
	LOC MIN	SEA-2, Static		SEA-2, Static		0.00	0	7.0	0.0	0.000	0.000	0.0	0.0	Yes
BUC SLN		1800.0	0.0	0.0	0.0	815		5.0	0	26	31	-103	0.20	Yes
		361.5		0.0		3		0.0	0	0	198	2	1.00	
107	ACT	HPBulb 140 x 7		12500	66.81	500.0	355	1.4	140.0	7.0	0.00	0.850	1800	
				4000		8.5	205	1.5	0.0	0.0	1.000	0.750	1550	
	LOC MIN	SEA-2, Static		SEA-2, Static		0.00	0	7.0	0.0	0.000	0.000	0.0	0.0	Yes
BUC SLN		1800.0	0.0	0.0	0.0	815		5.0	0	18	21	-103	0.18	Yes
		363.0		0.0		3		0.0	0	0	237	1	1.00	
108	ACT	HPBulb 140 x 7		12500	66.81	400.0	355	1.4	140.0	7.0	0.00	0.850	1800	
				4500		8.5	205	1.5	0.0	0.0	1.000	0.750	1600	
	LOC MIN	SEA-2, Static		SEA-2, Static		0.00	0	7.0	0.0	0.000	0.000	0.0	0.0	Yes
BUC SLN		1800.0	0.0	0.0	0.0	798		5.0	0	10	11	-104	0.14	Yes
		324.7		0.0		2		0.0	0	0	277	1	1.00	
7	ACT	Flatbar 200 x 15		0	0.00	0.0	0	1.5	200.0	15.0	0.00	0.000	0	
				0		14.5	0	1.5	0.0	0.0	0.000	0.000	0	
	LOC MIN					0.00	0	7.0	0.0	0.000	0.000	0.0	0.0	N/A
BUC SLN		0.0	0.0	0.0	0.0	0		12.5	0	0	0	0	0.00	Yes
		0.0		0.0		0		0.0	0	0	0	0	0.00	
9	ACT	Flatbar 200 x 15		12500	173.19	600.0	355	1.5	200.0	15.0	0.00	0.850	1800	
				7170		14.5	205	1.5	0.0	0.0	1.000	0.750	1208	
	LOC MIN	SEA-2, Static		Ice class - web thickness		0.00	0	7.0	13.5	0.000	0.000	0.0	484.7	Yes
BUC SLN		0.0	0.0	0.0	0.0	0		12.5	0	0	0	0	0.00	Yes
		0.0		0.0		0		0.0	0	0	0	0	0.00	
115	ACT	HPBulb 120 x 7		12500	53.99	550.0	355	0.5	120.3	7.0	0.00	0.850	1800	
				9500		9.0	205	0.5	0.0	0.0	1.000	0.750	1325	
	LOC MIN	SEA-2, Static		SEA-2, Static		0.00	0	6.0	0.0	0.000	0.000	0.0	0.0	Yes
BUC SLN		1800.0	0.0	0.0	0.0	583		4.0	0	97	111	35	0.41	Yes
		377.4		0.0		3		0.0	0	0	84	2	1.00	
116	ACT	HPBulb 120 x 7		12500	53.99	500.0	355	0.5	120.3	7.0	0.00	0.850	1800	
				10000		9.0	205	0.5	0.0	0.0	1.000	0.750	1550	
	LOC MIN	SEA-2, Static		SEA-2, Static		0.00	0	6.0	0.0	0.000	0.000	0.0	0.0	Yes
BUC SLN		1800.0	0.0	0.0	0.0	579		4.0	0	108	127	34	0.46	Yes
		363.0		0.0		3		0.0	0	0	73	2	1.00	
117	ACT	HPBulb 120 x 7		12500	53.99	500.0	355	0.5	120.3	7.0	0.00	0.842	1800	
				10500		9.0	205	0.5	0.0	0.0	1.000	0.750	1550	
	LOC MIN	SEA-2, Static		SEA-2, Static		0.00	0	6.0	0.0	0.000	0.000	0.0	0.0	Yes
BUC SLN		1800.0	0.0	0.0	0.0	579		4.0	0	120	141	32	0.50	Yes
		363.0		0.0		3		0.0	0	0	72	2	1.00	
118	ACT	HPBulb 120 x 7		12500	53.99	400.0	355	0.5	120.3	7.0	0.00	0.832	1800	
				11000		9.0	205	0.5	0.0	0.0	1.000	0.750	1600	
	LOC MIN	SEA-2, Static		SEA-2, Static		0.00	0	6.0	0.0	0.000	0.000	0.0	0.0	Yes
BUC SLN		1800.0	0.0	0.0	0.0	567		4.0	0	131	144	31	0.50	Yes
		324.7		0.0		2		0.0	0	0	64	2	1.00	
Strength Deck at #99														
1	ACT	HPBulb 100 x 7		500	36.87	500.0	355	0.5	100.3	7.0	0.00	0.828	1800	
				11300		7.0	205	0.5	0.0	0.0	1.000	0.750	1550	
	LOC MIN	UDL-2, Static		UDL-2, Static		1.62	2270	5.5	0.0	0.000	0.000	3.4	3.4	Yes
BUC SLN		1800.0	0.0	0.0	0.0	323		3.0	0	137	184	-2	0.66	Yes
		344.4		0.0		1		0.0	0	0	75	2	1.00	

2	ACT	HPBulb 100 x 7	1000 11300	36.87	500.0 7.0	355 205	0.5 0.5	100.3 0.0	7.0 0.0	0.00 1.000	0.828 0.750	1800 1550	
	LOC MIN	UDL-2, Static	UDL-2, Static		1.62	2270	5.5 0.0	0.0 0.7	0.000	0.000	3.4	3.4	Yes
	BUC SLN	1800.0 340.1	0.0	0.0 0.0	322 1		3.0 0.0	0	137 0	185 74	-4 2	0.66 1.00	Yes
3	ACT	HPBulb 100 x 7	1500 11300	36.87	500.0 7.0	355 205	0.5 0.5	100.3 0.0	7.0 0.0	0.00 1.000	0.828 0.750	1800 1550	
	LOC MIN	UDL-2, Static	UDL-2, Static		1.62	2270	5.5 0.0	0.0 0.7	0.000	0.000	3.4	3.4	Yes
	BUC SLN	1800.0 340.1	0.0	0.0 0.0	322 1		3.0 0.0	0	137 0	185 74	1 2	0.66 1.00	Yes
4	ACT	HPBulb 100 x 7	2000 11300	36.87	500.0 7.0	355 205	0.5 0.5	100.3 0.0	7.0 0.0	0.00 1.000	0.828 0.750	1800 1550	
	LOC MIN	UDL-2, Static	UDL-2, Static		1.62	2270	5.5 0.0	0.0 0.7	0.000	0.000	3.4	3.4	Yes
	BUC SLN	1800.0 340.1	0.0	0.0 0.0	322 1		3.0 0.0	0	137 0	185 74	1 2	0.66 1.00	Yes
6	ACT	HPBulb 100 x 7	2500 11300	36.87	500.0 7.0	355 205	0.5 0.5	100.3 0.0	7.0 0.0	0.00 1.000	0.828 0.750	1800 1550	
	LOC MIN	UDL-2, Static	UDL-2, Static		1.62	2270	5.5 0.0	0.0 0.7	0.000	0.000	3.4	3.4	Yes
	BUC SLN	1800.0 340.1	0.0	0.0 0.0	322 1		3.0 0.0	0	137 0	185 74	-9 2	0.66 1.00	Yes
7	ACT	HPBulb 100 x 7	3000 11300	36.87	500.0 7.0	355 205	0.5 0.5	100.3 0.0	7.0 0.0	0.00 1.000	0.828 0.750	1800 1550	
	LOC MIN	UDL-2, Static	UDL-2, Static		1.62	2270	5.5 0.0	0.0 0.7	0.000	0.000	3.4	3.4	Yes
	BUC SLN	1800.0 340.1	0.0	0.0 0.0	322 1		3.0 0.0	0	137 0	185 74	-10 2	0.67 1.00	Yes
8	ACT	HPBulb 100 x 7	3500 11300	36.87	500.0 7.0	355 205	0.5 0.5	100.3 0.0	7.0 0.0	0.00 1.000	0.828 0.750	1800 1425	
	LOC MIN	UDL-2, Static	UDL-2, Static		1.62	2270	5.5 0.0	0.0 0.7	0.000	0.000	3.4	3.4	Yes
	BUC SLN	1800.0 344.4	0.0	0.0 0.0	323 1		3.0 0.0	0	137 0	184 75	-12 2	0.66 1.00	Yes
10	ACT	HPBulb 100 x 7	4500 11300	36.87	500.0 7.0	355 205	0.5 0.5	100.3 0.0	7.0 0.0	0.00 1.000	0.828 0.750	1800 1425	
	LOC MIN	UDL-2, Static	UDL-2, Static		1.62	2270	5.5 0.0	0.0 0.7	0.000	0.000	3.4	3.4	Yes
	BUC SLN	1800.0 344.4	0.0	0.0 0.0	323 1		3.0 0.0	0	137 0	184 76	-14 2	0.66 1.00	Yes
11	ACT	HPBulb 100 x 7	5000 11300	36.87	500.0 7.0	355 205	0.5 0.5	100.3 0.0	7.0 0.0	0.00 1.000	0.828 0.750	1800 1550	
	LOC MIN	UDL-2, Static	UDL-2, Static		1.62	2270	5.5 0.0	0.0 0.7	0.000	0.000	3.4	3.4	Yes
	BUC SLN	1800.0 340.1	0.0	0.0 0.0	322 1		3.0 0.0	0	137 0	185 75	-15 2	0.67 1.00	Yes
12	ACT	HPBulb 100 x 7	5500 11300	36.87	400.0 7.0	355 205	0.5 0.5	100.3 0.0	7.0 0.0	0.00 1.000	0.828 0.750	1800 1550	
	LOC MIN	UDL-2, Static	UDL-2, Static		1.30	2838	5.5 0.0	0.0 0.7	0.000	0.000	3.4	3.4	Yes
	BUC SLN	1800.0 320.0	0.0	0.0 0.0	318 1		3.0 0.0	0	137 0	162 72	-17 2	0.58 1.00	Yes
13	ACT	HPBulb 100 x 7	6000 11300	36.81	350.0 7.0	355 205	0.5 0.5	100.3 0.0	7.0 0.0	0.00 1.000	0.828 0.750	1800 1550	
	LOC MIN	UDL-2, Static	UDL-2, Static		1.14	3238	5.5 0.0	0.0 0.7	0.000	0.000	3.4	3.4	Yes
	BUC SLN	1800.0 270.0	0.0	0.0 0.0	307 1		3.0 0.0	0	137 0	166 64	-16 2	0.57 1.00	Yes
14	ACT	HPBulb 100 x 7	6500 11300	36.87	500.0 7.0	355 205	0.5 0.5	100.3 0.0	7.0 0.0	0.00 1.000	0.828 0.750	1800 1550	
	LOC MIN	UDL-2, Static	UDL-2, Static		1.62	2270	5.5 0.0	0.0 0.7	0.000	0.000	3.4	3.4	Yes
	BUC SLN	1800.0 340.1	0.0	0.0 0.0	322 1		3.0 0.0	0	137 0	185 75	-17 2	0.67 1.00	Yes
16	ACT	HPBulb 100 x 7	7000 11300	36.87	500.0 7.0	355 205	0.5 0.5	100.3 0.0	7.0 0.0	0.00 1.000	0.828 0.750	1800 1550	
	LOC MIN	UDL-2, Static	UDL-2, Static		1.62	2270	5.5 0.0	0.0 0.7	0.000	0.000	3.4	3.4	Yes
	BUC SLN	1800.0 340.1	0.0	0.0 0.0	322 1		3.0 0.0	0	137 0	185 76	-19 2	0.67 1.00	Yes

17	ACT	HPBulb 100 x 7	7500 11300	36.87	500.0 7.0	355 205	0.5 0.5	100.3 0.0	7.0 0.0	0.00 1.000	0.828 0.750	1800 1550	
	LOC MIN	UDL-2, Static	UDL-2, Static		1.62	2270	5.5 0.0	0.0 0.7	0.000	0.000	3.4	3.4	Yes
BUC SLN		1800.0 340.1	0.0 0.0	0.0 0.0	322 1		3.0 0.0	0	137 0	185 76	-21 2	0.67 1.00	Yes
18	ACT	HPBulb 100 x 7	8000 11300	36.87	500.0 7.0	355 205	0.5 0.5	100.3 0.0	7.0 0.0	0.00 1.000	0.828 0.750	1800 1550	
	LOC MIN	UDL-2, Static	UDL-2, Static		1.62	2270	5.5 0.0	0.0 0.7	0.000	0.000	3.4	3.4	Yes
BUC SLN		1800.0 340.1	0.0 0.0	0.0 0.0	322 1		3.0 0.0	0	137 0	185 76	-22 2	0.67 1.00	Yes
19	ACT	HPBulb 100 x 7	8500 11300	36.87	500.0 7.0	355 205	0.5 0.5	100.3 0.0	7.0 0.0	0.00 1.000	0.828 0.750	1800 1550	
	LOC MIN	UDL-2, Static	UDL-2, Static		1.62	2270	5.5 0.0	0.0 0.7	0.000	0.000	3.4	3.4	Yes
BUC SLN		1800.0 340.1	0.0 0.0	0.0 0.0	322 1		3.0 0.0	0	137 0	185 76	-24 2	0.67 1.00	Yes
20	ACT	HPBulb 100 x 7	9000 11300	36.87	500.0 7.0	355 205	0.5 0.5	100.3 0.0	7.0 0.0	0.00 1.000	0.828 0.750	1800 1550	
	LOC MIN	UDL-2, Static	UDL-2, Static		1.62	2270	5.5 0.0	0.0 0.7	0.000	0.000	3.4	3.4	Yes
BUC SLN		1800.0 340.1	0.0 0.0	0.0 0.0	322 1		3.0 0.0	0	137 0	185 77	-25 2	0.67 1.00	Yes
21	ACT	HPBulb 100 x 7	9500 11300	36.87	500.0 7.0	355 205	0.5 0.5	100.3 0.0	7.0 0.0	0.00 1.000	0.828 0.750	1800 1550	
	LOC MIN	UDL-2, Static	UDL-2, Static		1.62	2270	5.5 0.0	0.0 0.7	0.000	0.000	3.4	3.4	Yes
BUC SLN		1800.0 340.1	0.0 0.0	0.0 0.0	322 1		3.0 0.0	0	137 0	185 77	-27 2	0.67 1.00	Yes
22	ACT	HPBulb 100 x 7	10000 11300	36.87	500.0 7.0	355 205	0.5 0.5	100.3 0.0	7.0 0.0	0.00 1.000	0.828 0.750	1800 1425	
	LOC MIN	UDL-2, Static	UDL-2, Static		1.62	2270	5.5 0.0	0.0 0.7	0.000	0.000	3.4	3.4	Yes
BUC SLN		1800.0 344.4	0.0 0.0	0.0 0.0	323 1		3.0 0.0	0	137 0	184 78	-29 2	0.67 1.00	Yes
24	ACT	HPBulb 100 x 7	11000 11300	36.87	500.0 7.0	355 205	0.5 0.5	100.3 0.0	7.0 0.0	0.00 1.000	0.828 0.750	1800 1425	
	LOC MIN	UDL-2, Static	UDL-2, Static		1.62	2270	5.5 0.0	0.0 0.7	0.000	0.000	3.4	3.4	Yes
BUC SLN		1800.0 344.4	0.0 0.0	0.0 0.0	323 1		3.0 0.0	0	137 0	184 79	-33 2	0.67 1.00	Yes
25	ACT	HPBulb 100 x 7	11500 11300	36.87	500.0 7.0	355 205	0.5 0.5	100.3 0.0	7.0 0.0	0.00 1.000	0.828 0.750	1800 1550	
	LOC MIN	UDL-2, Static	UDL-2, Static		1.62	2270	5.5 0.0	0.0 0.7	0.000	0.000	3.4	3.4	Yes
BUC SLN		1800.0 340.1	0.0 0.0	0.0 0.0	322 1		3.0 0.0	0	137 0	185 79	-35 2	0.68 1.00	Yes
26	ACT	HPBulb 100 x 7	12000 11300	36.87	500.0 7.0	355 205	0.5 0.5	100.3 0.0	7.0 0.0	0.00 1.000	0.828 0.750	1800 1550	
	LOC MIN	UDL-2, Static	UDL-2, Static		1.62	2270	5.5 0.0	0.0 0.7	0.000	0.000	3.4	3.4	Yes
BUC SLN		1800.0 344.4	0.0 0.0	0.0 0.0	323 1		3.0 0.0	0	137 0	184 80	-37 2	0.67 1.00	Yes
Deck_4800_4800 at #99													
38	ACT	HPBulb 120 x 7	5500 4800	46.07	340.0 5.6	355 205	1.4 1.5	120.0 0.0	7.0 0.0	0.00 1.000	0.850 0.750	1800 1630	
	LOC MIN	UDL-2, Static	UDL-2, Static		2.46	1873	6.5 0.0	0.0 1.1	0.000	0.000	7.8	7.8	Yes
BUC SLN		1800.0 234.0	0.0 0.0	0.0 0.0	416 0		4.0 0.0	0	7 0	9 37	0 4	0.03 1.00	Yes
39	ACT	HPBulb 120 x 7	6000 4800	46.24	500.0 5.6	355 205	1.4 1.5	120.0 0.0	7.0 0.0	0.00 1.000	0.850 0.750	1800 1550	
	LOC MIN	UDL-2, Static	UDL-2, Static		3.62	1279	6.5 0.0	0.0 1.1	0.000	0.000	7.8	7.8	Yes
BUC SLN		1800.0 287.9	0.0 0.0	0.0 0.0	440 1		4.0 0.0	0	7 0	11 41	0 5	0.04 1.00	Yes
40	ACT	HPBulb 120 x 7	6500 4800	46.24	500.0 5.6	355 205	1.4 1.5	120.0 0.0	7.0 0.0	0.00 1.000	0.850 0.750	1800 1550	
	LOC MIN	UDL-2, Static	UDL-2, Static		3.62	1279	6.5 0.0	0.0 1.1	0.000	0.000	7.8	7.8	Yes

BUC SLN		1800.0 287.9	0.0	0.0 0.0	0.0	440 1		4.0 0.0	0	7 0	11 41	0 5	0.04 1.00	Yes
43	ACT	HPBulb 120 x 7		7000 4800	46.24	400.0 5.6	355 205	1.4 1.5	120.0 0.0	7.0 0.0	0.00 1.000	0.850 0.750	1800 1550	
	LOC MIN	UDL-2, Static		UDL-2, Static		2.89	1598	6.5 0.0	0.0 1.1	0.000	0.000	7.8	7.8	Yes
BUC SLN		1800.0 275.6	0.0	0.0 0.0	0.0	435 1		4.0 0.0	0	7 0	9 40	0 5	0.03 1.00	Yes
44	ACT	HPBulb 120 x 7		7500 4800	46.16	350.0 5.6	355 205	1.4 1.5	120.0 0.0	7.0 0.0	0.00 1.000	0.850 0.750	1800 1550	
	LOC MIN	UDL-2, Static		UDL-2, Static		2.53	1823	6.5 0.0	0.0 1.1	0.000	0.000	7.8	7.8	Yes
BUC SLN		1800.0 244.0	0.0	0.0 0.0	0.0	421 1		4.0 0.0	0	7 0	9 38	0 4	0.03 1.00	Yes
45	ACT	HPBulb 120 x 7		8000 4800	46.24	500.0 5.6	355 205	1.4 1.5	120.0 0.0	7.0 0.0	0.00 1.000	0.850 0.750	1800 1550	
	LOC MIN	UDL-2, Static		UDL-2, Static		3.62	1279	6.5 0.0	0.0 1.1	0.000	0.000	7.8	7.8	Yes
BUC SLN		1800.0 287.9	0.0	0.0 0.0	0.0	440 1		4.0 0.0	0	7 0	11 42	-1 5	0.04 1.00	Yes
46	ACT	HPBulb 120 x 7		8500 4800	46.24	500.0 5.6	355 205	1.4 1.5	120.0 0.0	7.0 0.0	0.00 1.000	0.850 0.750	1800 1550	
	LOC MIN	UDL-2, Static		UDL-2, Static		3.62	1279	6.5 0.0	0.0 1.1	0.000	0.000	7.8	7.8	Yes
BUC SLN		1800.0 287.9	0.0	0.0 0.0	0.0	440 1		4.0 0.0	0	7 0	11 42	-1 5	0.04 1.00	Yes
47	ACT	HPBulb 120 x 7		9000 4800	46.24	500.0 5.6	355 205	1.4 1.5	120.0 0.0	7.0 0.0	0.00 1.000	0.850 0.750	1800 1550	
	LOC MIN	UDL-2, Static		UDL-2, Static		3.62	1279	6.5 0.0	0.0 1.1	0.000	0.000	7.8	7.8	Yes
BUC SLN		1800.0 287.9	0.0	0.0 0.0	0.0	440 1		4.0 0.0	0	7 0	11 43	-1 5	0.04 1.00	Yes
48	ACT	HPBulb 120 x 7		9500 4800	46.24	500.0 5.6	355 205	1.4 1.5	120.0 0.0	7.0 0.0	0.00 1.000	0.850 0.750	1800 1550	
	LOC MIN	UDL-2, Static		UDL-2, Static		3.62	1279	6.5 0.0	0.0 1.1	0.000	0.000	7.8	7.8	Yes
BUC SLN		1800.0 287.9	0.0	0.0 0.0	0.0	440 1		4.0 0.0	0	7 0	11 43	-1 5	0.04 1.00	Yes
49	ACT	HPBulb 120 x 7		10000 4800	46.24	500.0 5.6	355 205	1.4 1.5	120.0 0.0	7.0 0.0	0.00 1.000	0.850 0.750	1800 1550	
	LOC MIN	UDL-2, Static		UDL-2, Static		3.62	1279	6.5 0.0	0.0 1.1	0.000	0.000	7.8	7.8	Yes
BUC SLN		1800.0 287.9	0.0	0.0 0.0	0.0	440 1		4.0 0.0	0	7 0	11 43	-1 5	0.04 1.00	Yes
50	ACT	HPBulb 120 x 7		10500 4800	46.24	500.0 5.6	355 205	1.4 1.5	120.0 0.0	7.0 0.0	0.00 1.000	0.850 0.750	1800 1550	
	LOC MIN	UDL-2, Static		UDL-2, Static		3.62	1279	6.5 0.0	0.0 1.1	0.000	0.000	7.8	7.8	Yes
BUC SLN		1800.0 287.9	0.0	0.0 0.0	0.0	440 1		4.0 0.0	0	7 0	11 43	-1 5	0.04 1.00	Yes
51	ACT	HPBulb 120 x 7		11000 4800	46.24	500.0 5.6	355 205	1.4 1.5	120.0 0.0	7.0 0.0	0.00 1.000	0.850 0.750	1800 1550	
	LOC MIN	UDL-2, Static		UDL-2, Static		3.62	1279	6.5 0.0	0.0 1.1	0.000	0.000	7.8	7.8	Yes
BUC SLN		1800.0 287.9	0.0	0.0 0.0	0.0	440 1		4.0 0.0	0	7 0	11 44	-2 5	0.04 1.00	Yes
52	ACT	HPBulb 120 x 7		11500 4800	46.24	500.0 5.6	355 205	1.4 1.5	120.0 0.0	7.0 0.0	0.00 1.000	0.850 0.750	1800 1550	
	LOC MIN	UDL-2, Static		UDL-2, Static		3.62	1279	6.5 0.0	0.0 1.1	0.000	0.000	7.8	7.8	Yes
BUC SLN		1800.0 287.9	0.0	0.0 0.0	0.0	440 1		4.0 0.0	0	7 0	11 44	-2 5	0.04 1.00	Yes
53	ACT	HPBulb 120 x 7		12000 4800	46.24	500.0 5.6	355 205	1.4 1.5	120.0 0.0	7.0 0.0	0.00 1.000	0.850 0.750	1800 1550	
	LOC MIN	UDL-2, Static		UDL-2, Static		3.62	1279	6.5 0.0	0.0 1.1	0.000	0.000	7.8	7.8	Yes
BUC SLN		1800.0 290.3	0.0	0.0 0.0	0.0	441 1		4.0 0.0	0	7 0	11 44	-2 5	0.04 1.00	Yes
Deck_8100_8100 at #99														
27	ACT	HPBulb 120 x 7		500 8100	46.45	500.0 6.0	355 205	1.4 1.5	119.8 0.0	7.0 0.0	0.00 1.000	0.850 0.750	1800 1550	

	LOC MIN	UDL-2, Static		UDL-2, Static		1.15	4032	6.5 0.0	0.0 0.6	0.000	0.000	2.5	2.5	Yes
BUC SLN		1800.0 303.5	0.0	0.0 0.0	0.0	453 1		4.0 0.0	0	66 0	95 44	0 4	0.31 1.00	Yes
19	ACT	HPBulb 120 x 7		1000 8100	46.45	500.0 6.0	355 205	1.4 1.5	119.8 0.0	7.0 0.0	0.00 1.000	0.850 0.750	1800 1550	
	LOC MIN	UDL-2, Static		UDL-2, Static		1.15	4032	6.5 0.0	0.0 0.6	0.000	0.000	2.5	2.5	Yes
BUC SLN		1800.0 299.6	0.0	0.0 0.0	0.0	452 1		4.0 0.0	0	66 0	96 44	0 4	0.31 1.00	Yes
20	ACT	HPBulb 120 x 7		1500 8100	46.45	500.0 6.0	355 205	1.4 1.5	119.8 0.0	7.0 0.0	0.00 1.000	0.850 0.750	1800 1550	
	LOC MIN	UDL-2, Static		UDL-2, Static		1.15	4032	6.5 0.0	0.0 0.6	0.000	0.000	2.5	2.5	Yes
BUC SLN		1800.0 299.6	0.0	0.0 0.0	0.0	452 1		4.0 0.0	0	66 0	96 44	-3 4	0.31 1.00	Yes
24	ACT	HPBulb 120 x 7		2000 8100	46.45	500.0 6.0	355 205	1.4 1.5	119.8 0.0	7.0 0.0	0.00 1.000	0.850 0.750	1800 1550	
	LOC MIN	UDL-2, Static		UDL-2, Static		1.15	4032	6.5 0.0	0.0 0.6	0.000	0.000	2.5	2.5	Yes
BUC SLN		1800.0 299.6	0.0	0.0 0.0	0.0	452 1		4.0 0.0	0	66 0	96 44	1 4	0.31 1.00	Yes
22	ACT	HPBulb 120 x 7		2500 8100	46.45	500.0 6.0	355 205	1.4 1.5	119.8 0.0	7.0 0.0	0.00 1.000	0.850 0.750	1800 1550	
	LOC MIN	UDL-2, Static		UDL-2, Static		1.15	4032	6.5 0.0	0.0 0.6	0.000	0.000	2.5	2.5	Yes
BUC SLN		1800.0 299.6	0.0	0.0 0.0	0.0	452 1		4.0 0.0	0	66 0	96 44	1 4	0.31 1.00	Yes
26	ACT	HPBulb 120 x 7		3000 8100	46.45	500.0 6.0	355 205	1.4 1.5	119.8 0.0	7.0 0.0	0.00 1.000	0.850 0.750	1800 1550	
	LOC MIN	UDL-2, Static		UDL-2, Static		1.15	4032	6.5 0.0	0.0 0.6	0.000	0.000	2.5	2.5	Yes
BUC SLN		1800.0 299.6	0.0	0.0 0.0	0.0	452 1		4.0 0.0	0	66 0	96 44	-5 4	0.31 1.00	Yes
27	ACT	HPBulb 120 x 7		3500 8100	46.45	500.0 6.0	355 205	1.4 1.5	119.8 0.0	7.0 0.0	0.00 1.000	0.850 0.750	1800 1550	
	LOC MIN	UDL-2, Static		UDL-2, Static		1.15	4032	6.5 0.0	0.0 0.6	0.000	0.000	2.5	2.5	Yes
BUC SLN		1800.0 303.5	0.0	0.0 0.0	0.0	453 1		4.0 0.0	0	66 0	95 45	-6 4	0.31 1.00	Yes
29	ACT	HPBulb 120 x 7		4500 8100	46.45	500.0 6.0	355 205	1.4 1.5	119.8 0.0	7.0 0.0	0.00 1.000	0.850 0.750	1800 1550	
	LOC MIN	UDL-2, Static		UDL-2, Static		1.15	4032	6.5 0.0	0.0 0.6	0.000	0.000	2.5	2.5	Yes
BUC SLN		1800.0 303.5	0.0	0.0 0.0	0.0	453 1		4.0 0.0	0	66 0	95 48	-17 4	0.32 1.00	Yes
30	ACT	HPBulb 120 x 7		5000 8100	46.45	500.0 6.0	355 205	1.4 1.5	119.8 0.0	7.0 0.0	0.00 1.000	0.850 0.750	1800 1550	
	LOC MIN	UDL-2, Static		UDL-2, Static		1.15	4032	6.5 0.0	0.0 0.6	0.000	0.000	2.5	2.5	Yes
BUC SLN		1800.0 299.6	0.0	0.0 0.0	0.0	452 1		4.0 0.0	0	66 0	96 48	-18 4	0.32 1.00	Yes
31	ACT	HPBulb 120 x 7		5500 8100	46.45	400.0 6.0	355 205	1.4 1.5	119.8 0.0	7.0 0.0	0.00 1.000	0.850 0.750	1800 1600	
	LOC MIN	UDL-2, Static		UDL-2, Static		0.92	5040	6.5 0.0	0.0 0.6	0.000	0.000	2.5	2.5	Yes
BUC SLN		1800.0 287.0	0.0	0.0 0.0	0.0	447 1		4.0 0.0	0	66 0	84 47	-19 4	0.28 1.00	Yes
32	ACT	HPBulb 120 x 7		6000 8100	46.37	350.0 6.0	355 205	1.4 1.5	119.8 0.0	7.0 0.0	0.00 1.000	0.850 0.750	1800 1625	
	LOC MIN	UDL-2, Static		UDL-2, Static		0.81	5750	6.5 0.0	0.0 0.6	0.000	0.000	2.5	2.5	Yes
BUC SLN		1800.0 249.8	0.0	0.0 0.0	0.0	432 1		4.0 0.0	0	66 0	83 49	-32 4	0.28 1.00	Yes
33	ACT	HPBulb 120 x 7		6500 8100	46.45	500.0 6.0	355 205	1.4 1.5	119.8 0.0	7.0 0.0	0.00 1.000	0.850 0.750	1800 1550	
	LOC MIN	UDL-2, Static		UDL-2, Static		1.15	4032	6.5 0.0	0.0 0.6	0.000	0.000	2.5	2.5	Yes
BUC SLN		1800.0 299.6	0.0	0.0 0.0	0.0	452 1		4.0 0.0	0	66 0	96 56	-32 4	0.33 1.00	Yes
35	ACT	HPBulb 120 x 7		7000 8100	46.45	500.0 6.0	355 205	1.4 1.5	119.8 0.0	7.0 0.0	0.00 1.000	0.850 0.750	1800 1550	

	LOC MIN	UDL-2, Static		UDL-2, Static		1.15	4032	6.5 0.0	0.0 0.6	0.000	0.000	2.5	2.5	Yes
BUC SLN		1800.0 299.6	0.0	0.0 0.0	0.0	452 1		4.0 0.0	0	66 0	96 56	-33 4	0.33 1.00	Yes
36	ACT	HPBulb 120 x 7		7500 8100	46.45	500.0 6.0	355 205	1.4 1.5	119.8 0.0	7.0 0.0	0.00 1.000	0.850 0.750	1800 1550	
	LOC MIN	UDL-2, Static		UDL-2, Static		1.15	4032	6.5 0.0	0.0 0.6	0.000	0.000	2.5	2.5	Yes
BUC SLN		1800.0 299.6	0.0	0.0 0.0	0.0	452 1		4.0 0.0	0	66 0	96 57	-34 4	0.33 1.00	Yes
37	ACT	HPBulb 120 x 7		8000 8100	46.45	500.0 6.0	355 205	1.4 1.5	119.8 0.0	7.0 0.0	0.00 1.000	0.850 0.750	1800 1550	
	LOC MIN	UDL-2, Static		UDL-2, Static		1.15	4032	6.5 0.0	0.0 0.6	0.000	0.000	2.5	2.5	Yes
BUC SLN		1800.0 299.6	0.0	0.0 0.0	0.0	452 1		4.0 0.0	0	66 0	96 57	-35 4	0.33 1.00	Yes
38	ACT	HPBulb 120 x 7		8500 8100	46.45	500.0 6.0	355 205	1.4 1.5	119.8 0.0	7.0 0.0	0.00 1.000	0.850 0.750	1800 1550	
	LOC MIN	UDL-2, Static		UDL-2, Static		1.15	4032	6.5 0.0	0.0 0.6	0.000	0.000	2.5	2.5	Yes
BUC SLN		1800.0 299.6	0.0	0.0 0.0	0.0	452 1		4.0 0.0	0	66 0	96 58	-36 4	0.33 1.00	Yes
39	ACT	HPBulb 120 x 7		9000 8100	46.45	500.0 6.0	355 205	1.4 1.5	119.8 0.0	7.0 0.0	0.00 1.000	0.850 0.750	1800 1550	
	LOC MIN	UDL-2, Static		UDL-2, Static		1.15	4032	6.5 0.0	0.0 0.6	0.000	0.000	2.5	2.5	Yes
BUC SLN		1800.0 299.6	0.0	0.0 0.0	0.0	452 1		4.0 0.0	0	66 0	96 58	-37 4	0.33 1.00	Yes
40	ACT	HPBulb 120 x 7		9500 8100	46.45	500.0 6.0	355 205	1.4 1.5	119.8 0.0	7.0 0.0	0.00 1.000	0.850 0.750	1800 1550	
	LOC MIN	UDL-2, Static		UDL-2, Static		1.15	4032	6.5 0.0	0.0 0.6	0.000	0.000	2.5	2.5	Yes
BUC SLN		1800.0 299.6	0.0	0.0 0.0	0.0	452 1		4.0 0.0	0	66 0	96 59	-37 4	0.33 1.00	Yes
41	ACT	HPBulb 120 x 7		10000 8100	46.45	500.0 6.0	355 205	1.4 1.5	119.8 0.0	7.0 0.0	0.00 1.000	0.850 0.750	1800 1425	
	LOC MIN	UDL-2, Static		UDL-2, Static		1.15	4032	6.5 0.0	0.0 0.6	0.000	0.000	2.5	2.5	Yes
BUC SLN		1800.0 303.5	0.0	0.0 0.0	0.0	453 1		4.0 0.0	0	66 0	95 60	-38 4	0.33 1.00	Yes
43	ACT	HPBulb 120 x 7		11000 8100	46.45	500.0 6.0	355 205	1.4 1.5	119.8 0.0	7.0 0.0	0.00 1.000	0.850 0.750	1800 1425	
	LOC MIN	UDL-2, Static		UDL-2, Static		1.15	4032	6.5 0.0	0.0 0.6	0.000	0.000	2.5	2.5	Yes
BUC SLN		1800.0 303.5	0.0	0.0 0.0	0.0	453 1		4.0 0.0	0	66 0	95 62	-41 4	0.33 1.00	Yes
44	ACT	HPBulb 120 x 7		11500 8100	46.45	500.0 6.0	355 205	1.4 1.5	119.8 0.0	7.0 0.0	0.00 1.000	0.850 0.750	1800 1550	
	LOC MIN	UDL-2, Static		UDL-2, Static		1.15	4032	6.5 0.0	0.0 0.6	0.000	0.000	2.5	2.5	Yes
BUC SLN		1800.0 299.6	0.0	0.0 0.0	0.0	452 1		4.0 0.0	0	66 0	96 62	-42 4	0.33 1.00	Yes
45	ACT	HPBulb 120 x 7		12000 8100	46.45	500.0 6.0	355 205	1.4 1.5	119.8 0.0	7.0 0.0	0.00 1.000	0.850 0.750	1800 1550	
	LOC MIN	UDL-2, Static		UDL-2, Static		1.15	4032	6.5 0.0	0.0 0.6	0.000	0.000	2.5	2.5	Yes
BUC SLN		1800.0 303.5	0.0	0.0 0.0	0.0	453 1		4.0 0.0	0	66 0	95 63	-42 4	0.33 1.00	Yes
Inner bottom at #99														
54	ACT	HPBulb 140 x 7		0 1400	66.81	500.0 8.5	355 205	1.4 1.5	140.0 0.0	7.0 0.0	0.00 1.000	0.832 0.750	1800 1550	
	LOC MIN	UDL-2, Static		UDL-2, Static		3.70	1808	6.5 0.0	0.0 1.3	0.000	0.000	7.8	7.8	Yes
BUC SLN		1800.0 363.0	0.0	0.0 0.0	0.0	815 3		5.0 0.0	0	87 0	109 46	0 4	0.36 1.00	Yes
46	ACT	HPBulb 140 x 7		500 1400	66.81	500.0 8.5	355 205	1.4 1.5	140.0 0.0	7.0 0.0	0.00 1.000	0.832 0.750	1800 1550	
	LOC MIN	UDL-2, Static		UDL-2, Static		3.70	1808	6.5 0.0	0.0 1.3	0.000	0.000	7.8	7.8	Yes
BUC SLN		1800.0 363.0	0.0	0.0 0.0	0.0	815 3		5.0 0.0	0	87 0	106 47	0 4	0.35 1.00	Yes

48	ACT	HPBulb 140 x 7	1500 1400	66.81	500.0 8.5	355 205	1.4 1.5	140.0 0.0	7.0 0.0	0.00 1.000	0.832 0.750	1800 1550	
	LOC MIN	UDL-2, Static	UDL-2, Static		3.70	1808	6.5 0.0	0.0 4.8	0.000	0.000	7.8	7.8	Yes
BUC SLN		1800.0 363.0	0.0 0.0	0.0 0.0	815 3		5.0 0.0	0	87 0	106 47	1 4	0.35 1.00	Yes
49	ACT	HPBulb 140 x 7	2000 1400	66.81	500.0 8.5	355 205	1.4 1.5	140.0 0.0	7.0 0.0	0.00 1.000	0.832 0.750	1800 1550	
	LOC MIN	UDL-2, Static	UDL-2, Static		3.70	1808	6.5 0.0	0.0 4.8	0.000	0.000	7.8	7.8	Yes
BUC SLN		1800.0 363.0	0.0 0.0	0.0 0.0	815 3		5.0 0.0	0	87 0	109 46	1 4	0.36 1.00	Yes
50	ACT	HPBulb 140 x 7	2500 1400	66.81	500.0 8.5	355 205	1.4 1.5	140.0 0.0	7.0 0.0	0.00 1.000	0.832 0.750	1800 1550	
	LOC MIN	UDL-2, Static	UDL-2, Static		3.70	1808	6.5 0.0	0.0 4.8	0.000	0.000	7.8	7.8	Yes
BUC SLN		1800.0 363.0	0.0 0.0	0.0 0.0	815 3		5.0 0.0	0	87 0	106 47	1 4	0.35 1.00	Yes
52	ACT	HPBulb 140 x 7	3500 1400	74.23	500.0 9.0	355 205	0.5 0.5	140.3 0.0	7.0 0.0	0.00 1.000	1.000 0.950	1800 1550	
	LOC MIN	TK-2, Static	TK-2, Static		51.78	143	6.0 0.0	2.0 4.8	0.000	0.000	-132.2	-132.2	Yes
BUC SLN		1800.0 363.0	0.0 0.0	0.0 0.0	902 3		4.5 0.0	-132	0 0	0 120	0 5	0.35 1.00	Yes
53	ACT	HPBulb 140 x 7	4000 1400	74.23	500.0 9.0	355 205	0.5 0.5	140.3 0.0	7.0 0.0	0.00 1.000	1.000 0.950	1800 1550	
	LOC MIN	TK-2, Static	TK-2, Static		51.78	143	6.0 0.0	2.0 4.8	0.000	0.000	-132.2	-132.2	Yes
BUC SLN		1800.0 363.0	0.0 0.0	0.0 0.0	902 3		4.5 0.0	-132	0 0	0 120	0 5	0.35 1.00	Yes
54	ACT	HPBulb 140 x 7	4500 1400	74.23	500.0 9.0	355 205	0.5 0.5	140.3 0.0	7.0 0.0	0.00 1.000	1.000 0.950	1800 1550	
	LOC MIN	TK-2, Static	TK-2, Static		51.78	143	6.0 0.0	2.0 4.8	0.000	0.000	-132.2	-132.2	Yes
BUC SLN		1800.0 363.0	0.0 0.0	0.0 0.0	902 3		4.5 0.0	-132	0 0	0 120	0 5	0.35 1.00	Yes
55	ACT	HPBulb 140 x 7	5000 1400	74.23	500.0 9.0	355 205	0.5 0.5	140.3 0.0	7.0 0.0	0.00 1.000	1.000 0.950	1800 1550	
	LOC MIN	TK-2, Static	TK-2, Static		51.78	143	6.0 0.0	2.0 4.8	0.000	0.000	-132.2	-132.2	Yes
BUC SLN		1800.0 363.0	0.0 0.0	0.0 0.0	902 3		4.5 0.0	-132	0 0	0 120	0 5	0.35 1.00	Yes
56	ACT	HPBulb 140 x 7	5500 1400	74.23	500.0 9.0	355 205	0.5 0.5	140.3 0.0	7.0 0.0	0.00 1.000	1.000 0.950	1800 1425	
	LOC MIN	TK-2, Static	TK-2, Static		51.78	143	6.0 0.0	2.0 4.8	0.000	0.000	-132.2	-132.2	Yes
BUC SLN		1800.0 363.0	0.0 0.0	0.0 0.0	902 3		4.5 0.0	-132	0 0	0 120	0 5	0.35 1.00	Yes
58	ACT	HPBulb 140 x 7	6500 1400	74.23	500.0 9.0	355 205	0.5 0.5	140.3 0.0	7.0 0.0	0.00 1.000	1.000 0.950	1800 1425	
	LOC MIN	TK-2, Static	TK-2, Static		51.78	143	6.0 0.0	2.0 4.8	0.000	0.000	-132.2	-132.2	Yes
BUC SLN		1800.0 363.0	0.0 0.0	0.0 0.0	902 3		4.5 0.0	-132	0 0	0 120	0 5	0.35 1.00	Yes
59	ACT	HPBulb 140 x 7	7000 1400	74.23	500.0 9.0	355 205	0.5 0.5	140.3 0.0	7.0 0.0	0.00 1.000	1.000 0.950	1800 1550	
	LOC MIN	TK-2, Static	TK-2, Static		51.78	143	6.0 0.0	2.0 4.8	0.000	0.000	-132.2	-132.2	Yes
BUC SLN		1800.0 363.0	0.0 0.0	0.0 0.0	902 3		4.5 0.0	-132	0 0	0 120	0 5	0.35 1.00	Yes
60	ACT	HPBulb 140 x 7	7500 1400	73.76	500.0 8.5	355 205	0.5 0.5	140.3 0.0	7.0 0.0	0.00 1.000	1.000 0.950	1800 1550	
	LOC MIN	TK-2, Static	TK-2, Static		51.78	142	6.0 0.0	2.0 4.8	0.000	0.000	-132.2	-132.2	Yes
BUC SLN		1800.0 363.0	0.0 0.0	0.0 0.0	902 3		4.5 0.0	-132	0 0	0 120	0 5	0.35 1.00	Yes
61	ACT	HPBulb 140 x 7	8000 1400	73.76	500.0 8.5	355 205	0.5 0.5	140.3 0.0	7.0 0.0	0.00 1.000	1.000 0.950	1800 1550	
	LOC MIN	TK-2, Static	TK-2, Static		51.78	142	6.0 0.0	2.0 4.8	0.000	0.000	-132.2	-132.2	Yes
BUC SLN		1800.0 363.0	0.0 0.0	0.0 0.0	902 3		4.5 0.0	-132	0 0	0 120	0 5	0.35 1.00	Yes

62	ACT	HPBulb 140 x 7	8500 1400	73.76	500.0 8.5	355 205	0.5 0.5	140.3 0.0	7.0 0.0	0.00 1.000	1.000 0.950	1800 1550	
	LOC MIN	TK-2, Static	TK-2, Static		51.78	142	6.0 0.0	2.0 4.8	0.000	0.000	-132.2	-132.2	Yes
BUC SLN		1800.0 363.0	0.0 0.0	0.0 0.0	902 3		4.5 0.0	-132 0	0 120	0 5	0 5	0.35 1.00	Yes
64	ACT	HPBulb 160 x 11	9500 1400	119.98	500.0 8.5	355 205	1.5 1.5	160.0 0.0	11.0 0.0	0.00 1.000	0.831 0.750	1800 1550	
	LOC MIN	UDL-2, Static	UDL-2, Static		3.70	3244	6.5 0.0	0.0 1.3	0.000	0.000	7.8	7.8	Yes
BUC SLN		1800.0 363.0	0.0 0.0	0.0 0.0	1539 3		5.5 0.0	0 0	87 0	100 34	-30 3	0.32 1.00	Yes
65	ACT	HPBulb 160 x 11	10000 1400	119.98	500.0 8.5	355 205	1.5 1.5	160.0 0.0	11.0 0.0	0.00 1.000	0.831 0.750	1800 1550	
	LOC MIN	UDL-2, Static	UDL-2, Static		3.70	3244	6.5 0.0	0.0 1.3	0.000	0.000	7.8	7.8	Yes
BUC SLN		1800.0 363.0	0.0 0.0	0.0 0.0	1539 3		5.5 0.0	0 0	87 0	101 34	-31 3	0.32 1.00	Yes
66	ACT	HPBulb 160 x 11	10500 1400	119.98	500.0 8.5	355 205	1.5 1.5	160.0 0.0	11.0 0.0	0.00 1.000	0.831 0.750	1800 1550	
	LOC MIN	UDL-2, Static	UDL-2, Static		3.70	3244	6.5 0.0	0.0 1.3	0.000	0.000	7.8	7.8	Yes
BUC SLN		1800.0 363.0	0.0 0.0	0.0 0.0	1539 3		5.5 0.0	0 0	87 0	101 35	-33 3	0.32 1.00	Yes
67	ACT	HPBulb 160 x 11	11000 1400	119.98	500.0 8.5	355 205	1.5 1.5	160.0 0.0	11.0 0.0	0.00 1.000	0.831 0.750	1800 1550	
	LOC MIN	UDL-2, Static	UDL-2, Static		3.70	3244	6.5 0.0	0.0 1.3	0.000	0.000	7.8	7.8	Yes
BUC SLN		1800.0 363.0	0.0 0.0	0.0 0.0	1539 3		5.5 0.0	0 0	87 0	101 35	-34 3	0.32 1.00	Yes
68	ACT	HPBulb 160 x 11	11500 1400	119.98	441.6 8.5	355 205	1.5 1.5	160.0 0.0	11.0 0.0	0.00 1.000	0.831 0.750	1800 1579	
	LOC MIN	UDL-2, Static	UDL-2, Static		3.27	3672	6.5 0.0	0.0 1.3	0.000	0.000	7.8	7.8	Yes
BUC SLN		1800.0 342.3	0.0 0.0	0.0 0.0	1515 2		5.5 0.0	0 0	87 0	94 35	-35 3	0.30 1.00	Yes
LongPlaneBulkhead9000_9000 Split1 at #99													
0	ACT	HPBulb 160 x 8	9000 530	107.11	446.1 8.0	355 205	0.5 0.5	160.3 0.0	8.0 0.0	0.00 1.000	0.000 0.950	1800 1577	
	LOC MIN	Sea chest, -	TK-2, Static		99.89	107	6.0 0.0	2.0 5.7	7.200	0.000	200.0	-140.9	Yes
BUC SLN		1800.0 344.0	0.0 0.0	0.0 0.0	1372 2		5.0 0.0	-9 0	107 0	123 33	-3 4	0.39 1.00	Yes
1	ACT	HPBulb 160 x 8	9000 1100	107.11	435.0 8.0	355 205	0.5 0.5	160.3 0.0	8.0 0.0	0.00 1.000	0.000 0.950	1800 1582	
	LOC MIN	Sea chest, -	TK-2, Static		97.42	110	6.0 0.0	2.0 5.7	7.200	0.000	200.0	-135.2	Yes
BUC SLN		1800.0 339.7	0.0 0.0	0.0 0.0	1368 2		5.0 0.0	-3 0	94 0	108 30	1 4	0.34 1.00	Yes
LongPlaneBulkhead3000_3000 Split1 at #99													
0	ACT	HPBulb 120 x 9	3000 450	56.16	500.0 8.0	355 205	1.5 1.5	119.8 0.0	9.0 0.0	0.00 1.000	1.000 0.950	1800 1550	
	LOC MIN	TK-2, Static	TK-2, Static		55.52	101	7.0 0.0	3.0 6.0	0.000	0.000	141.7	141.7	Yes
BUC SLN		1800.0 363.0	0.0 0.0	0.0 0.0	583 2		4.0 0.0	0 0	109 0	132 59	0 3	0.45 1.00	Yes
1	ACT	HPBulb 120 x 9	3000 1050	56.16	475.0 8.0	355 205	1.5 1.5	119.8 0.0	9.0 0.0	0.00 1.000	1.000 0.950	1800 1563	
	LOC MIN	TK-2, Static	TK-2, Static		50.50	111	7.0 0.0	2.5 6.0	0.000	0.000	135.7	135.7	Yes
BUC SLN		1800.0 354.7	0.0 0.0	0.0 0.0	580 2		4.0 0.0	0 0	95 0	113 57	-2 2	0.38 1.00	Yes
Girder6000 at #99													
0	ACT	HPBulb 100 x 6	6000 470	34.38	485.5 8.5	355 205	0.5 0.5	100.0 0.0	6.0 0.0	0.00 1.000	0.807 0.750	1800 1557	
	LOC MIN	INT-1, Static	INT-1, Static		5.65	608	5.5 0.0	0.5 2.0	7.200	7.200	12.0	12.0	Yes
BUC SLN		1800.0 358.3	0.0 0.0	0.0 0.0	316 2		3.0 0.0	0 0	109 0	135 98	0 2	0.53 1.00	Yes
1	ACT	HPBulb 100 x 6	6000 1100	34.38	465.0 8.5	355 205	0.5 0.5	100.0 0.0	6.0 0.0	0.00 1.000	0.827 0.750	1800 1568	

	LOC MIN	INT-1, Static		INT-1, Static		5.29	650	5.5 0.0	0.5 2.0	7.200	7.200	12.0	12.0	Yes
BUC SLN		1800.0 351.1	0.0	0.0 0.0	0.0	315 2		3.0 0.0	0	94 0	118 93	1 2	0.45 1.00	Yes

General Panel 2 at #99

27	ACT	Flatbar 60 x 8		0	0.00	0.0	0	0.5 0.5	60.0 0.0	8.0 0.0	0.00 0.000	0.000 0.000	0	
	LOC MIN					0.00	0	5.5 0.0	0.0 0.0	0.000	0.000	0.0	0.0	Yes
BUC SLN		600.0 236.5	0.0	0.0 0.0	0.0	51 1		4.0 0.0	0	120 0	159 77	-4 0	0.57 1.00	Yes

28	ACT	Flatbar 60 x 8		0	0.00	0.0	0	0.5 0.5	60.0 0.0	8.0 0.0	0.00 0.000	0.000 0.000	0	
	LOC MIN					0.00	0	5.5 0.0	0.0 0.0	0.000	0.000	0.0	0.0	Yes
BUC SLN		600.0 242.7	0.0	0.0 0.0	0.0	51 1		4.0 0.0	0	108 0	167 75	-5 0	0.60 1.00	Yes

22	ACT	Flatbar 60 x 8		0	0.00	0.0	0	0.5 0.5	60.0 0.0	8.0 0.0	0.00 0.000	0.000 0.000	0	
	LOC MIN					0.00	0	5.5 0.0	0.0 0.0	0.000	0.000	0.0	0.0	Yes
BUC SLN		600.0 242.7	0.0	0.0 0.0	0.0	51 1		4.0 0.0	0	97 0	149 75	1 0	0.53 1.00	Yes

29	ACT	Flatbar 60 x 8		0	0.00	0.0	0	0.5 0.5	60.0 0.0	8.0 0.0	0.00 0.000	0.000 0.000	0	
	LOC MIN					0.00	0	5.5 0.0	0.0 0.0	0.000	0.000	0.0	0.0	Yes
BUC SLN		600.0 242.7	0.0	0.0 0.0	0.0	51 1		4.0 0.0	0	86 0	132 75	1 0	0.47 1.00	Yes

30	ACT	Flatbar 60 x 8		0	0.00	0.0	0	0.5 0.5	60.0 0.0	8.0 0.0	0.00 0.000	0.000 0.000	0	
	LOC MIN					0.00	0	5.5 0.0	0.0 0.0	0.000	0.000	0.0	0.0	Yes
BUC SLN		600.0 239.5	0.0	0.0 0.0	0.0	51 1		4.0 0.0	0	75 0	103 77	2 0	0.37 1.00	Yes

General Panel 3 at #99

20	ACT	Flatbar 60 x 8		0	0.00	0.0	0	0.5 0.5	60.0 0.0	8.0 0.0	0.00 0.000	0.000 0.000	0	
	LOC MIN					0.00	0	5.5 0.0	0.0 0.0	0.000	0.000	0.0	0.0	Yes
BUC SLN		600.0 236.5	0.0	0.0 0.0	0.0	51 1		4.0 0.0	0	120 0	159 77	-6 0	0.57 1.00	Yes

21	ACT	Flatbar 60 x 8		0	0.00	0.0	0	0.5 0.5	60.0 0.0	8.0 0.0	0.00 0.000	0.000 0.000	0	
	LOC MIN					0.00	0	5.5 0.0	0.0 0.0	0.000	0.000	0.0	0.0	Yes
BUC SLN		600.0 242.7	0.0	0.0 0.0	0.0	51 1		4.0 0.0	0	108 0	167 75	-7 0	0.60 1.00	Yes

19	ACT	Flatbar 60 x 8		0	0.00	0.0	0	0.5 0.5	60.0 0.0	8.0 0.0	0.00 0.000	0.000 0.000	0	
	LOC MIN					0.00	0	5.5 0.0	0.0 0.0	0.000	0.000	0.0	0.0	Yes
BUC SLN		600.0 242.7	0.0	0.0 0.0	0.0	51 1		4.0 0.0	0	97 0	149 75	2 0	0.53 1.00	Yes

18	ACT	Flatbar 60 x 8		0	0.00	0.0	0	0.5 0.5	60.0 0.0	8.0 0.0	0.00 0.000	0.000 0.000	0	
	LOC MIN					0.00	0	5.5 0.0	0.0 0.0	0.000	0.000	0.0	0.0	Yes
BUC SLN		600.0 242.7	0.0	0.0 0.0	0.0	51 1		4.0 0.0	0	86 0	132 75	2 0	0.47 1.00	Yes

27	ACT	Flatbar 60 x 8		0	0.00	0.0	0	0.5 0.5	60.0 0.0	8.0 0.0	0.00 0.000	0.000 0.000	0	
	LOC MIN					0.00	0	5.5 0.0	0.0 0.0	0.000	0.000	0.0	0.0	Yes
BUC SLN		600.0 239.5	0.0	0.0 0.0	0.0	51 1		4.0 0.0	0	75 0	103 77	2 0	0.37 1.00	Yes

General Panel 4 at #99

2	ACT	HPBulb 120 x 7		0	0.00	0.0	0	1.4 1.5	120.0 0.0	7.0 0.0	0.00 0.000	0.000 0.000	0	
	LOC MIN					0.00	0	6.5 0.0	0.0 0.0	0.000	0.000	0.0	0.0	Yes

BUC		1800.0	0.0	0.0	0.0	520		4.0	0	110	134	0	0.47	Yes
SLN		363.0		0.0		3		0.0		0	68	3	1.00	
0	ACT	HPBulb		0	0.00	0.0	0	1.4	120.0	7.0	0.00	0.000	0	
		120 x 7		0		8.5	0	1.5	0.0	0.0	0.000	0.000	0	
	LOC					0.00	0	6.5	0.0	0.000	0.000	0.0	0.0	Yea
	MIN							0.0	0.0					
BUC		1800.0	0.0	0.0	0.0	520		4.0	0	96	117	0	0.41	Yes
SLN		363.0		0.0		3		0.0		0	68	3	1.00	

3.6.4. Provjera poprečnih nosača

Stiff. No	Identifikacija uzdužnjaka
ACT	Stvarne dimenzije uzdužnjaka
Type	Tip profila
Dimension	Dimenzije profila
y	Y koordinata [mm]
z	Z koordinata [mm]
Spacing	Razmak između uzdužnjaka [mm]
t_{pl_net}	Stvarna ebljina struka [mm]
R_{eH}	Granica razvlačenja [N/mm ²]
τ_{eH}	$R_{eH} / (3)^{0.5}$ [N/mm ²]
t_{cf}	Korozijski dodatak za flanžu [mm]
t_{cw}	Korozijski dodatak za struk [mm]
h_w	Visina struka [mm]
b_f	Širina flanže [mm]
t_w	Debljina struka [mm]
t_f	Debljina flanže [mm]
X	Koeficijent
C_m	Koeficijent za kombinaciju aksijalnih, savijajućih i smičnih naprezanja
C_s	Dopušteni koeficijent savijanja
C_t	Dopušteni koeficijent smicanja
l_{bdg}	Efektivni raspon savijanja [mm]
l_{shr}	Efektivni raspon smicanja [mm]
LOC/MIN	Minimalni zahtjevi za lokalna opterećenja
Load ref.	Referenca opterećenja po Z os for Z
Load ref.	Referenca opterećenja za debljinu struka for t_w
Z_{req}	Minimalni otpor presjeka [cm ³]
$Z_{Rel. req}$	Z Stvarni / zahtjev [%]
$t_{w min}$	Minimalna debljina struka [mm]
$t_{f min}$	Minimalna debljina flanže [mm]
$t_{w shear}$	Minimalna debljina struka (uvijanje) [mm]
$t_{pl min net}$	Zahtjevanja debljina opločenja [mm]

draught _Z	Gaz za Z_{net}
draught _{t_w}	Gaz za $t_{w\ shear}$
p_Z / F_{sc}	Projektni tlak za Z_{net} [kN/m ²] ili čelična vitla, i.e. BC-9 or BC-10 [kN]
p_{t_w}	Projektni tlak za $t_{w\ shear}$ [kN/m ²]
OK?	Jesu li zahtjevi ispunjeni
BUC/SLN	Zahtjevi za uvijanje i odnos dimenzija
Span	Raspon [mm]
b_{eff}	Efektivna širina opločenja [mm]
$b_{f\ sl}$	Minimalna debljina flanže (vitkost) [mm]
I_{buc}	Stvarni moment inercije prema Ch8, Sec5, 2.3.5. [cm ⁴]
I_{req}	Zahtjevani moment inercije prema Ch8, Sec5, 2.3.5. [cm ⁴]
I_{slend}	Actual net moment of inertia including plate flange with effective width = $0.8*s$ [cm ⁴]
$t_{w\ min\ sl}$	Minimalna debljina struka (vitkost) [mm]
$t_{f\ min\ sl}$	Minimalna debljina flanže (vitkost) [mm]
p_{lat}	Bočni pritisak [kN/m ²]
σ_x	Napreznje u smjeru X-osi [N/mm ²]
σ_y	Nprezanje u smjeru Y-osi [N/mm ²]
σ_a	Aksijalno naprezanje [N/mm ²]
σ_b	Savojno naprezanje [N/mm ²]
τ	Smično napezanje [N/mm ²]
σ_w	Naprezanje zbog uvijanja [N/mm ²]
η_{actual}	Eta stvarno
η_{allow}	Eta dopušteno
FAT	Rezultati zamora
ConnType	Vrsta spoja

Stiff. No	ACT	Type Dimension		y z [mm]	Z _{net} [cm ³]	Spacing t _{pl,net} [mm]	R _{eH} τ _{eff} [N/mm ²]	t _{cw} t _{cf} [mm]	h _{w,net} b _r [mm]	t _w t _r [mm]	X C _m	C _s C _t	l _{bdg} l _{shr} [mm]		
		LOC MIN	Load ref. for Z		Load ref. for t _w		Z _{req} [cm ³]	Z _{Rel,req} [%]	t _{w,min} t _{r,min} [mm]	t _{w,shear} t _{pl,min,net} [mm]	draught _Z [m]	draught _{t_w} [m]	p _Z [kN/m ²]	p _{t_w} [kN/m ²]	OK?
		BUC SLN	Span b _{eff} [mm]	Est. Z _{req} [cm ³]	Est. h _{w,req} Est. t _{r,req} [mm]	b _{r,st} [mm]	I _{buc} I _{r,req} [cm ⁴]		t _{w,min,st} t _{r,min,st} [mm]	Plat [kN/m ²]	σ _x σ _y [N/mm ²]	σ _a σ _b [N/mm ²]	τ σ _w [N/mm ²]	η _{actual} η _{allow}	OK?

Frame #99 (64510 mm from A.P.)

Outer shell at #99

0	ACT	Built up T from plates 208 x 100 x 8 x 8		12494 3032	209.64	600.0 8.5	355 205	1.5 1.5	201.5 100.0	8.0 8.0	0.00 1.000	0.850 0.750	3465.2 3165.2	
	LOC MIN	SEA-2, Static		SEA-2, Static		0.00	0	7.0 7.0	0.0 0.0	0.000	0.000	0.0	0.0	Yes
	BUC SLN	0.0 0.0	0.0	0.0 0.0	1.5	0 0	4.0 6.0	0	0	0	0	0	0.00 0.00	Yes
0	ACT	Built up T from plates 339 x 100 x 9 x 9		12500 4900	272.05	600.0 8.5	355 205	1.5 1.5	331.5 100.0	9.0 9.0	0.00 1.000	0.850 0.750	200.0 0.0	
	LOC MIN	SEA-2, Static		SEA-2, Static		0.00	0	7.0 7.0	0.0 0.0	0.000	0.000	0.0	0.0	Yes
	BUC SLN	0.0 0.0	0.0	0.0 0.0	66.0	0 0	7.0 6.0	0	0	0	0	0	0.00 0.00	Yes
0	ACT	Built up T from plates 339 x 100 x 9 x 9		12500 5750	477.65	300.0 14.5	355 205	1.5 1.5	331.5 100.0	9.0 9.0	0.00 1.000	0.850 0.750	1500.0 1350.0	
	LOC MIN	SEA-2, Static		Ice class - web thickness		0.00	0	7.0 7.0	9.0 0.0	0.000	0.000	0.0	839.5	Yes
	BUC SLN	1500.0 254.4	0.0	0.0 0.0	66.0	11640 8	7.0 6.0	0	0	0	0	0	0.07 1.00	Yes
0	ACT	Built up T from plates 339 x 100 x 9 x 9		12500 10100	556.54	600.0 14.5	355 205	0.5 0.5	331.0 100.0	9.0 9.0	0.00 1.000	0.850 0.750	2400.0 2100.0	
	LOC MIN	SEA-2, Static		SEA-2, Static		0.00	0	6.0 6.0	0.0 0.0	0.000	0.000	0.0	0.0	Yes
	BUC SLN	0.0 0.0	0.0	0.0 0.0	66.0	0 0	6.0 5.0	0	0	0	0	0	0.00 0.00	Yes

Strength Deck at #99

0	ACT	Built up T from plates 460 x 150 x 10 x 10		2000 11300	1094.20	600.0 7.0	355 205	0.5 0.5	450.8 150.0	10.0 10.0	0.00 1.000	0.850 0.750	4000.0 3700.0	
	LOC MIN	UDL-2, Static		UDL-2, Static		9.10	12020	5.5 5.5	0.0 0.7	0.000	0.000	3.4	3.4	Yes
	BUC SLN	0.0 0.0	0.0	0.0 0.0	90.0	0 0	8.0 7.5	0	0	0	0	0	0.00 0.00	Yes
0	ACT	Built up T from plates 460 x 150 x 10 x 10		4900 11300	1025.92	600.0 7.0	355 205	0.5 0.5	450.8 150.0	10.0 10.0	0.00 1.000	0.850 0.750	1800.0 1500.0	
	LOC MIN	UDL-2, Static		UDL-2, Static		1.84	55655	5.5 5.5	0.0 0.7	0.000	0.000	3.4	3.4	Yes
	BUC SLN	0.0 0.0	0.0	0.0 0.0	90.0	0 0	8.0 7.5	0	0	0	0	0	0.00 0.00	Yes
0	ACT	Built up T from plates 460 x 150 x 10 x 10		8150 11300	1094.20	600.0 7.0	355 205	0.5 0.5	450.8 150.0	10.0 10.0	0.00 1.000	0.850 0.750	4700.0 4400.0	
	LOC MIN	UDL-2, Static		UDL-2, Static		12.57	8706	5.5 5.5	0.0 0.7	0.000	0.000	3.4	3.4	Yes
	BUC SLN	0.0 0.0	0.0	0.0 0.0	90.0	0 0	8.0 7.5	0	0	0	0	0	0.00 0.00	Yes

Deck_4800_4800 at #99

0	ACT	Built up T from plates 550 x 150 x 11 x 10		6310 4800	1299.64	600.0 5.6	355 205	1.5 1.5	541.5 150.0	11.0 10.0	0.00 1.000	0.850 0.750	5200.0 1680.0	
	LOC MIN	UDL-2, Static		UDL-2, Static		35.16	3696	6.5 6.5	0.0 1.1	0.000	0.000	7.8	7.8	Yes
	BUC SLN	0.0 0.0	0.0	0.0 0.0	108.0	0 0	10.5 8.5	0	0	0	0	0	0.00 0.00	Yes

Deck_8100_8100 at #99

0	ACT	Built up T from plates 550 x 150 x 11 x 10		2000 8100	1311.58	600.0 6.0	355 205	1.5 1.5	541.3 150.0	11.0 10.0	0.00 1.000	0.850 0.750	4000.0 3700.0	
	LOC MIN	UDL-2, Static		UDL-2, Static		6.63	19788	6.5 6.5	0.0 0.6	0.000	0.000	2.5	2.5	Yes
	BUC SLN	0.0 0.0	0.0	0.0 0.0	108.0	0 0	10.5 8.5	0	0	0	0	0	0.00 0.00	Yes

Stiff. No	ACT	Type Dimension		y z [mm]	Z _{net} [cm ³]	Spacing t _{pl_net} [mm]	R _{eH} τ _{eff} [N/mm ²]	t _{cw} t _{cf} [mm]	h _{w_net} d _r [mm]	t _w t _r [mm]	X C _m	C _s C _t	l _{bdg} l _{shr} [mm]		
		LOC MIN	Load ref. for Z		Load ref. for t _w		Z _{req} [cm ³]	Z _{Rel.req} [%]	t _{w min} t _{r min} [mm]	t _{w shear} t _{pl min_net} [mm]	draught _Z [m]	draught _{t_w} [m]	p _Z [kN/m ²]	p _{t_w} [kN/m ²]	OK?
		BUC SLN	Span b _{eff} [mm]	Est. Z _{req} [cm ³]	Est. h _{w req} Est. t _{r req} [mm]	b _{r st} [mm]	I _{buc} I _{req} [cm ⁴]		t _{w min st} t _{r min st} [mm]	Plat [kN/m ²]	σ _x σ _y [N/mm ²]	σ _a σ _b [N/mm ²]	τ σ _w [N/mm ²]	η _{actual} η _{allow}	OK?
0	ACT	Built up T from plates 550 x 150 x 11 x 10		4900 8100	1221.22	600.0 6.0	355 205	1.5 1.5	541.3 150.0	11.0 10.0	0.00 1.000	0.850 0.750	1800.0 1500.0		
	LOC MIN	UDL-2, Static		UDL-2, Static		1.34	90988	6.5 6.5	0.0 0.6	0.000	0.000	2.5	2.5	Yes	
	BUC SLN	0.0 0.0	0.0	0.0 0.0	108.0	0 0	10.5 8.5	0	0	0	0	0	0.00 0.00	Yes	
0	ACT	Built up T from plates 550 x 150 x 11 x 10		8150 8100	1311.58	600.0 6.0	355 205	1.5 1.5	541.3 150.0	11.0 10.0	0.00 1.000	0.850 0.750	4700.0 4400.0		
	LOC MIN	UDL-2, Static		UDL-2, Static		9.15	14333	6.5 6.5	0.0 0.6	0.000	0.000	2.5	2.5	Yes	
	BUC SLN	0.0 0.0	0.0	0.0 0.0	108.0	0 0	10.5 8.5	0	0	0	0	0	0.00 0.00	Yes	

General Panel 2 at #99

0	ACT	HPBulb 120 x 7		0 0	0.00	0.0 6.5	0 0	0.5 0.5	120.0 0.0	7.0 0.0	0.00 0.000	0.000 0.000	0.0 0.0	
	LOC MIN					0.00	0	5.5 0.0	0.0 0.0	0.000	0.000	0.0	0.0	N/A
	BUC SLN	0.0 0.0	0.0	0.0 0.0	0.0	0 0	4.0 0.0	0	0	0	0	0	0.00 0.00	Yes

General Panel 3 at #99

0	ACT	HPBulb 120 x 7		0 0	0.00	0.0 6.5	0 0	0.5 0.5	120.0 0.0	7.0 0.0	0.00 0.000	0.000 0.000	0.0 0.0	
	LOC MIN					0.00	0	5.5 0.0	0.0 0.0	0.000	0.000	0.0	0.0	N/A
	BUC SLN	0.0 0.0	0.0	0.0 0.0	0.0	0 0	4.0 0.0	0	0	0	0	0	0.00 0.00	Yes

3.6.5. Provjera spojeva elemenata strukture

ID	Identifikacija poprečnog nosača
End/shear conn	Primjenjeni spoj
t_c PSM	Korozijski dodatak spoja [mm]
t_c web stiff	Korozijski dodatak strka elementa strukture [mm]
PSM web angle	Kut spoja primarnog elementa strukture [deg]
S1, S2	Razmak između primarnog strukturnog elementa prema pramcu i krmi od promatrane pozicije [m]
R_{eH}	Granica razvlačenja [N/mm ²]
σ_w perm, σ_w	Dozvoljno i stvarno naprezanje struka uzdužnjaka dalje od zavara [N/mm ²]
σ_{wc} perm, σ_{wc}	Dozvoljno i stvarno naprezanje struka uzdužnjaka dalje pri zavaru [N/mm ²]
τ perm, τ_w	Dopušteno i stvarno smično naprezanje zavara [N/mm ²]
W	Ukupno opterećenje zavara [kN]
W1, W2	Preneseno opterećenje zavarom, W1, i opterećenje spojem uzdužnjaka, W2 [kN]
l_{leg} web stiff	Dužina zavara za struk uzdužnjaka [mm]
l_{leg} brkt	Dužina zavara za struk potpornog nosača [mm]
l_{leg} direct	Dužina zavara za direktni smični spoj [mm]
l_{leg} lug	Dužina zavara za priključak na smični spoj [mm]
f_{weld}	Faktor zavara
f_c	Okolišni koeficijent
l_s	Ukupna dužina smičnog spoja [mm]
d_{wc}	Ukupna dužina spoja struka uzdužnjaka i potpornog nosača [mm]

ID	ACT aft fwd	End conn Shear conn						t_c PSM [mm]	t_c web stiff [mm]	PSM web angle ϕ_w [deg]	S1 [m]	S2 [m]	R_{eH} PSM [N/mm ²]	R_{eH} web stiff [N/mm ²]	OK?
		σ_w perm [N/mm ²]		σ_w [N/mm ²]		σ_{wc} perm [N/mm ²]									
WELD aft fwd	l_{leg} web stiff [mm]		l_{leg} brkt [mm]		l_{leg} direct [mm]		l_{leg} lug [mm]		f_{weld}	f_c	l_s [mm]	d_{wc} [mm]	OK?		
	req	act	req	act	req	act	req	act							

Frame #99 (64510 mm from A.P.)

Outer shell at #99

69	ACT aft	(31) EC31 (Da) Direct without lug asym, t=10						1.5	0.0	90.0	1.8	1.8	355.0	0.0	
	fwd	(31) EC31 (Da) Direct without lug asym, t=10						1.5	0.0	90.0	1.8	1.8	355.0	0.0	
	YIELD aft	0.0	0.0	0.0	0.0	0.0	0.0	0.0	145.5	0.0	0.0	0.0	0.0	0.0	Yes
	fwd	0.0	0.0	0.0	0.0	0.0	0.0	0.0	145.5	0.0	0.0	0.0	0.0	0.0	Yes
54	ACT aft	(31) EC31 (Da) Direct without lug asym, t=10						1.5	0.0	90.0	1.8	1.8	355.0	0.0	
	fwd	(31) EC31 (Da) Direct without lug asym, t=10						1.5	0.0	90.0	1.8	1.8	355.0	0.0	
	YIELD aft	0.0	0.0	0.0	0.0	0.0	0.0	0.0	145.5	0.0	0.0	0.0	0.0	0.0	Yes
	fwd	0.0	0.0	0.0	0.0	0.0	0.0	0.0	145.5	0.0	0.0	0.0	0.0	0.0	Yes
65	ACT aft	(31) EC31 (Da) Direct without lug asym, t=10						0.5	0.0	90.0	1.8	1.8	355.0	0.0	
	fwd	(31) EC31 (Da) Direct without lug asym, t=10						0.5	0.0	90.0	1.8	1.8	355.0	0.0	
	YIELD aft	0.0	0.0	0.0	0.0	0.0	0.0	0.0	184.5	124.4	112.3	112.3	112.3	0.0	Yes
	fwd	0.0	0.0	0.0	0.0	0.0	0.0	0.0	184.5	124.4	112.3	112.3	112.3	0.0	Yes
66	ACT aft	(31) EC31 (Da) Direct without lug asym, t=10						0.5	0.0	90.0	1.8	1.8	355.0	0.0	
	fwd	(31) EC31 (Da) Direct without lug asym, t=10						0.5	0.0	90.0	1.8	1.8	355.0	0.0	
	YIELD aft	0.0	0.0	0.0	0.0	0.0	0.0	0.0	184.5	124.3	112.2	112.2	112.2	0.0	Yes
	fwd	0.0	0.0	0.0	0.0	0.0	0.0	0.0	184.5	124.3	112.2	112.2	112.2	0.0	Yes
67	ACT aft	(31) EC31 (Da) Direct without lug asym, t=10						0.5	0.0	90.0	1.8	1.8	355.0	0.0	
	fwd	(31) EC31 (Da) Direct without lug asym, t=10						0.5	0.0	90.0	1.8	1.8	355.0	0.0	
	YIELD aft	0.0	0.0	0.0	0.0	0.0	0.0	0.0	184.5	124.2	112.1	112.1	112.1	0.0	Yes
	fwd	0.0	0.0	0.0	0.0	0.0	0.0	0.0	184.5	124.2	112.1	112.1	112.1	0.0	Yes
68	ACT aft	(31) EC31 (Da) Direct without lug asym, t=10						0.5	0.0	90.0	1.8	1.8	355.0	0.0	
	fwd	(31) EC31 (Da) Direct without lug asym, t=10						0.5	0.0	90.0	1.8	1.8	355.0	0.0	
	YIELD aft	0.0	0.0	0.0	0.0	0.0	0.0	0.0	184.5	124.1	112.0	112.0	112.0	0.0	Yes
	fwd	0.0	0.0	0.0	0.0	0.0	0.0	0.0	184.5	124.1	112.0	112.0	112.0	0.0	Yes
69	ACT aft	(31) EC31 (Da) Direct without lug asym, t=10						0.5	0.0	90.0	1.8	1.8	355.0	0.0	
	fwd	(31) EC31 (Da) Direct without lug asym, t=10						0.5	0.0	90.0	1.8	1.8	355.0	0.0	
	YIELD aft	0.0	0.0	0.0	0.0	0.0	0.0	0.0	184.5	124.0	111.9	111.9	111.9	0.0	Yes
	fwd	0.0	0.0	0.0	0.0	0.0	0.0	0.0	184.5	124.0	111.9	111.9	111.9	0.0	Yes
81	ACT aft	(31) EC31 (Da) Direct without lug asym, t=10						1.5	0.0	90.0	1.8	1.8	355.0	0.0	
	fwd	(31) EC31 (Da) Direct without lug asym, t=10						1.5	0.0	90.0	1.8	1.8	355.0	0.0	
	YIELD aft	0.0	0.0	0.0	0.0	0.0	0.0	0.0	145.5	0.0	0.0	0.0	0.0	0.0	Yes
	fwd	0.0	0.0	0.0	0.0	0.0	0.0	0.0	145.5	0.0	0.0	0.0	0.0	0.0	Yes
81	ACT aft	(31) EC31 (Da) Direct without lug asym, t=10						1.5	0.0	90.0	1.8	1.8	355.0	0.0	
	fwd	(31) EC31 (Da) Direct without lug asym, t=10						1.5	0.0	90.0	1.8	1.8	355.0	0.0	
	YIELD aft	0.0	0.0	0.0	0.0	0.0	0.0	0.0	145.5	0.0	0.0	0.0	0.0	0.0	Yes
	fwd	0.0	0.0	0.0	0.0	0.0	0.0	0.0	145.5	0.0	0.0	0.0	0.0	0.0	Yes

ID	ACT aft fwd	End conn Shear conn						t _c PSM [mm]	t _c web stiff [mm]	PSM web angle φ _w [deg]	S1 [m]	S2 [m]	R _{eH} PSM [N/mm ²]	R _{eH} web stiff [N/mm ²]	OK?
		σ _w perm [N/mm ²]		σ _w [N/mm ²]		σ _{wc} perm [N/mm ²]									
WELD aft fwd	l _{leg} web stiff [mm]	l _{leg} brkt [mm]		l _{leg} direct [mm]		l _{leg} lug [mm]		f _{weld}	f _c	l _s [mm]	d _{wc} [mm]			OK?	
		req	act	req	act	req	act								req
82	ACT aft	(31) EC31 (Da) Direct without lug asym, t=10						1.5	0.0	90.0	1.8	1.8	355.0	0.0	
	fwd	(31) EC31 (Da) Direct without lug asym, t=10						1.5	0.0	90.0	1.8	1.8	355.0	0.0	
	YIELD aft	0.0	0.0	0.0	0.0	0.0	0.0	0.0	145.5	0.0	0.0	0.0	0.0	Yes	
	fwd	0.0	0.0	0.0	0.0	0.0	0.0	0.0	145.5	0.0	0.0	0.0	0.0		
	WELD aft	0.0	0.0	0.0	0.0	4.0	6.0	0.0	0.3	1.0	0.0	0.0		Yes	
	fwd	0.0	0.0	0.0	0.0	4.0	6.0	0.0	0.3	1.0	0.0	0.0			
93	ACT aft	(31) EC31 (Da) Direct without lug asym, t=10						1.5	0.0	90.0	1.8	1.8	355.0	0.0	
	fwd	(31) EC31 (Da) Direct without lug asym, t=10						1.5	0.0	90.0	1.8	1.8	355.0	0.0	
	YIELD aft	0.0	0.0	0.0	0.0	0.0	0.0	0.0	145.5	0.0	0.0	0.0	0.0	Yes	
	fwd	0.0	0.0	0.0	0.0	0.0	0.0	0.0	145.5	0.0	0.0	0.0	0.0		
	WELD aft	0.0	0.0	0.0	0.0	4.0	6.0	0.0	0.3	1.0	0.0	0.0		Yes	
	fwd	0.0	0.0	0.0	0.0	4.0	6.0	0.0	0.3	1.0	0.0	0.0			
105	ACT aft	(31) EC31 (Da) Direct without lug asym, t=10						1.5	0.0	90.0	1.8	1.8	355.0	0.0	
	fwd	(31) EC31 (Da) Direct without lug asym, t=10						1.5	0.0	90.0	1.8	1.8	355.0	0.0	
	YIELD aft	0.0	0.0	0.0	0.0	0.0	0.0	0.0	145.5	0.0	0.0	0.0	0.0	Yes	
	fwd	0.0	0.0	0.0	0.0	0.0	0.0	0.0	145.5	0.0	0.0	0.0	0.0		
	WELD aft	0.0	0.0	0.0	0.0	4.0	6.0	0.0	0.3	1.0	0.0	0.0		Yes	
	fwd	0.0	0.0	0.0	0.0	4.0	6.0	0.0	0.3	1.0	0.0	0.0			
106	ACT aft	(31) EC31 (Da) Direct without lug asym, t=10						1.5	0.0	90.0	1.8	1.8	355.0	0.0	
	fwd	(31) EC31 (Da) Direct without lug asym, t=10						1.5	0.0	90.0	1.8	1.8	355.0	0.0	
	YIELD aft	0.0	0.0	0.0	0.0	0.0	0.0	0.0	145.5	0.0	0.0	0.0	0.0	Yes	
	fwd	0.0	0.0	0.0	0.0	0.0	0.0	0.0	145.5	0.0	0.0	0.0	0.0		
	WELD aft	0.0	0.0	0.0	0.0	4.0	6.0	0.0	0.3	1.0	0.0	0.0		Yes	
	fwd	0.0	0.0	0.0	0.0	4.0	6.0	0.0	0.3	1.0	0.0	0.0			
55	ACT aft	(31) EC31 (Da) Direct without lug asym, t=10						1.5	0.0	90.0	1.8	1.8	355.0	0.0	
	fwd	(31) EC31 (Da) Direct without lug asym, t=10						1.5	0.0	90.0	1.8	1.8	355.0	0.0	
	YIELD aft	0.0	0.0	0.0	0.0	0.0	0.0	0.0	145.5	0.0	0.0	0.0	0.0	Yes	
	fwd	0.0	0.0	0.0	0.0	0.0	0.0	0.0	145.5	0.0	0.0	0.0	0.0		
	WELD aft	0.0	0.0	0.0	0.0	4.0	6.0	0.0	0.3	1.0	0.0	0.0		Yes	
	fwd	0.0	0.0	0.0	0.0	4.0	6.0	0.0	0.3	1.0	0.0	0.0			
107	ACT aft	(31) EC31 (Da) Direct without lug asym, t=10						1.5	0.0	90.0	1.8	1.8	355.0	0.0	
	fwd	(31) EC31 (Da) Direct without lug asym, t=10						1.5	0.0	90.0	1.8	1.8	355.0	0.0	
	YIELD aft	0.0	0.0	0.0	0.0	0.0	0.0	0.0	145.5	0.0	0.0	0.0	0.0	Yes	
	fwd	0.0	0.0	0.0	0.0	0.0	0.0	0.0	145.5	0.0	0.0	0.0	0.0		
	WELD aft	0.0	0.0	0.0	0.0	4.0	6.0	0.0	0.3	1.0	0.0	0.0		Yes	
	fwd	0.0	0.0	0.0	0.0	4.0	6.0	0.0	0.3	1.0	0.0	0.0			
108	ACT aft	(31) EC31 (Da) Direct without lug asym, t=10						1.5	0.0	90.0	1.8	1.8	355.0	0.0	
	fwd	(31) EC31 (Da) Direct without lug asym, t=10						1.5	0.0	90.0	1.8	1.8	355.0	0.0	
	YIELD aft	0.0	0.0	0.0	0.0	0.0	0.0	0.0	145.5	0.0	0.0	0.0	0.0	Yes	
	fwd	0.0	0.0	0.0	0.0	0.0	0.0	0.0	145.5	0.0	0.0	0.0	0.0		
	WELD aft	0.0	0.0	0.0	0.0	4.0	6.0	0.0	0.3	1.0	0.0	0.0		Yes	
	fwd	0.0	0.0	0.0	0.0	4.0	6.0	0.0	0.3	1.0	0.0	0.0			
115	ACT aft	(31) EC31 (Da) Direct without lug asym, t=10						0.5	0.0	90.0	1.8	1.8	355.0	0.0	
	fwd	(31) EC31 (Da) Direct without lug asym, t=10						0.5	0.0	90.0	1.8	1.8	355.0	0.0	
	YIELD aft	0.0	0.0	0.0	0.0	0.0	0.0	0.0	145.5	0.0	0.0	0.0	0.0	Yes	
	fwd	0.0	0.0	0.0	0.0	0.0	0.0	0.0	145.5	0.0	0.0	0.0	0.0		
	WELD aft	0.0	0.0	0.0	0.0	4.0	6.0	0.0	0.3	1.0	0.0	0.0		Yes	
	fwd	0.0	0.0	0.0	0.0	4.0	6.0	0.0	0.3	1.0	0.0	0.0			
116	ACT aft	(31) EC31 (Da) Direct without lug asym, t=10						0.5	0.0	90.0	1.8	1.8	355.0	0.0	
	fwd	(31) EC31 (Da) Direct without lug asym, t=10						0.5	0.0	90.0	1.8	1.8	355.0	0.0	
	YIELD aft	0.0	0.0	0.0	0.0	0.0	0.0	0.0	145.5	0.0	0.0	0.0	0.0	Yes	
	fwd	0.0	0.0	0.0	0.0	0.0	0.0	0.0	145.5	0.0	0.0	0.0	0.0		
	WELD aft	0.0	0.0	0.0	0.0	4.0	6.0	0.0	0.3	1.0	0.0	0.0		Yes	
	fwd	0.0	0.0	0.0	0.0	4.0	6.0	0.0	0.3	1.0	0.0	0.0			

ID	ACT aft fwd	End conn Shear conn						t _c PSM [mm]	t _c web stiff [mm]	PSM web angle φ _w [deg]	S1 [m]	S2 [m]	R _{eH} PSM [N/mm ²]	R _{eH} web stiff [N/mm ²]	OK?
		σ _w perm [N/mm ²]		σ _w [N/mm ²]		σ _{wc} perm [N/mm ²]									
WELD aft fwd	l _{leg} web stiff [mm]	l _{leg} brkt [mm]		l _{leg} direct [mm]		l _{leg} lug [mm]		f _{weld}	f _c	l _s [mm]	d _{wc} [mm]			OK?	
		req	act	req	act	req	act								req
117	ACT aft	(31) EC31 (Da) Direct without lug asym, t=10						0.5	0.0	90.0	1.8	1.8	355.0	0.0	
	fwd	(31) EC31 (Da) Direct without lug asym, t=10						0.5	0.0	90.0	1.8	1.8	355.0	0.0	
	YIELD aft fwd	0.0	0.0	0.0	0.0	0.0	0.0	0.0	145.5	0.0	0.0	0.0	0.0	0.0	Yes
	WELD aft fwd	0.0	0.0	0.0	0.0	4.0	6.0	0.0	0.0	0.3	1.0	0.0	0.0	0.0	Yes
118	ACT aft	(31) EC31 (Da) Direct without lug asym, t=10						0.5	0.0	90.0	1.8	1.8	355.0	0.0	
	fwd	(31) EC31 (Da) Direct without lug asym, t=10						0.5	0.0	90.0	1.8	1.8	355.0	0.0	
	YIELD aft fwd	0.0	0.0	0.0	0.0	0.0	0.0	0.0	145.5	0.0	0.0	0.0	0.0	0.0	Yes
	WELD aft fwd	0.0	0.0	0.0	0.0	4.0	6.0	0.0	0.0	0.3	1.0	0.0	0.0	0.0	Yes
142	ACT aft	(31) EC31 (Da) Direct without lug asym, t=10						1.5	0.0	90.0	1.8	1.8	355.0	0.0	
	fwd	(31) EC31 (Da) Direct without lug asym, t=10						1.5	0.0	90.0	1.8	1.8	355.0	0.0	
	YIELD aft fwd	0.0	0.0	0.0	0.0	0.0	0.0	0.0	145.5	0.0	0.0	0.0	0.0	0.0	Yes
	WELD aft fwd	0.0	0.0	0.0	0.0	4.0	6.0	0.0	0.0	0.3	1.0	0.0	0.0	0.0	Yes
136	ACT aft	(31) EC31 (Da) Direct without lug asym, t=10						1.5	0.0	90.0	1.8	1.8	355.0	0.0	
	fwd	(31) EC31 (Da) Direct without lug asym, t=10						1.5	0.0	90.0	1.8	1.8	355.0	0.0	
	YIELD aft fwd	0.0	0.0	0.0	0.0	0.0	0.0	0.0	145.5	0.0	0.0	0.0	0.0	0.0	Yes
	WELD aft fwd	0.0	0.0	0.0	0.0	4.0	6.0	0.0	0.0	0.3	1.0	0.0	0.0	0.0	Yes
137	ACT aft	(31) EC31 (Da) Direct without lug asym, t=10						1.5	0.0	90.0	1.8	1.8	355.0	0.0	
	fwd	(31) EC31 (Da) Direct without lug asym, t=10						1.5	0.0	90.0	1.8	1.8	355.0	0.0	
	YIELD aft fwd	0.0	0.0	0.0	0.0	0.0	0.0	0.0	145.5	0.0	0.0	0.0	0.0	0.0	Yes
	WELD aft fwd	0.0	0.0	0.0	0.0	4.0	6.0	0.0	0.0	0.3	1.0	0.0	0.0	0.0	Yes
138	ACT aft	(31) EC31 (Da) Direct without lug asym, t=10						1.5	0.0	90.0	1.8	1.8	355.0	0.0	
	fwd	(31) EC31 (Da) Direct without lug asym, t=10						1.5	0.0	90.0	1.8	1.8	355.0	0.0	
	YIELD aft fwd	0.0	0.0	0.0	0.0	0.0	0.0	0.0	145.5	0.0	0.0	0.0	0.0	0.0	Yes
	WELD aft fwd	0.0	0.0	0.0	0.0	4.0	6.0	0.0	0.0	0.3	1.0	0.0	0.0	0.0	Yes
56	ACT aft	(31) EC31 (Da) Direct without lug asym, t=10						1.5	0.0	90.0	1.8	1.8	355.0	0.0	
	fwd	(31) EC31 (Da) Direct without lug asym, t=10						1.5	0.0	90.0	1.8	1.8	355.0	0.0	
	YIELD aft fwd	0.0	0.0	0.0	0.0	0.0	0.0	0.0	145.5	0.0	0.0	0.0	0.0	0.0	Yes
	WELD aft fwd	0.0	0.0	0.0	0.0	4.0	6.0	0.0	0.0	0.3	1.0	0.0	0.0	0.0	Yes
139	ACT aft	(31) EC31 (Da) Direct without lug asym, t=10						1.5	0.0	90.0	1.8	1.8	355.0	0.0	
	fwd	(31) EC31 (Da) Direct without lug asym, t=10						1.5	0.0	90.0	1.8	1.8	355.0	0.0	
	YIELD aft fwd	0.0	0.0	0.0	0.0	0.0	0.0	0.0	145.5	0.0	0.0	0.0	0.0	0.0	Yes
	WELD aft fwd	0.0	0.0	0.0	0.0	4.0	6.0	0.0	0.0	0.3	1.0	0.0	0.0	0.0	Yes
7	ACT aft	(31) EC31 (Da) Direct without lug asym, t=10						1.5	0.0	90.0	1.8	1.8	355.0	0.0	
	fwd	(31) EC31 (Da) Direct without lug asym, t=10						1.5	0.0	90.0	1.8	1.8	355.0	0.0	
	YIELD aft fwd	0.0	0.0	0.0	0.0	0.0	0.0	0.0	145.5	0.0	0.0	0.0	0.0	0.0	Yes
	WELD aft fwd	0.0	0.0	0.0	0.0	4.0	6.0	0.0	0.0	0.3	1.0	0.0	0.0	0.0	Yes

ID	ACT aft fwd	End conn Shear conn						t _c PSM [mm]	t _c web stiff [mm]	PSM web angle φ _w [deg]	S1 [m]	S2 [m]	R _{eH} PSM [N/mm ²]	R _{eH} web stiff [N/mm ²]	OK?
		σ _w perm [N/mm ²]		σ _w [N/mm ²]		σ _{wc} perm [N/mm ²]									
WELD aft fwd	l _{leg} web stiff [mm]	l _{leg} brkt [mm]		l _{leg} direct [mm]		l _{leg} lug [mm]		f _{weld}	f _c	l _s [mm]	d _{we} [mm]	OK?			
		req	act	req	act	req	act						req	act	
9	ACT aft	(31) EC31 (Da) Direct without lug asym, t=10						1.5	0.0	90.0	1.8	1.8	355.0	0.0	
	fwd	(31) EC31 (Da) Direct without lug asym, t=10						1.5	0.0	90.0	1.8	1.8	355.0	0.0	
	YIELD aft	0.0	0.0	0.0	0.0	0.0	0.0	0.0	145.5	0.0	0.0	0.0	0.0	0.0	Yes
	fwd	0.0	0.0	0.0	0.0	0.0	0.0	0.0	145.5	0.0	0.0	0.0	0.0	0.0	
WELD aft	0.0	0.0	0.0	0.0	4.0	6.0	0.0	0.0	0.3	1.0	0.0	0.0		Yes	
fwd	0.0	0.0	0.0	0.0	4.0	6.0	0.0	0.0	0.3	1.0	0.0	0.0			
57	ACT aft	(31) EC31 (Da) Direct without lug asym, t=10						1.5	0.0	90.0	1.8	1.8	355.0	0.0	
	fwd	(31) EC31 (Da) Direct without lug asym, t=10						1.5	0.0	90.0	1.8	1.8	355.0	0.0	
	YIELD aft	0.0	0.0	0.0	0.0	0.0	0.0	0.0	145.5	0.0	0.0	0.0	0.0	0.0	Yes
	fwd	0.0	0.0	0.0	0.0	0.0	0.0	0.0	145.5	0.0	0.0	0.0	0.0	0.0	
WELD aft	0.0	0.0	0.0	0.0	4.0	6.0	0.0	0.0	0.3	1.0	0.0	0.0		Yes	
fwd	0.0	0.0	0.0	0.0	4.0	6.0	0.0	0.0	0.3	1.0	0.0	0.0			
59	ACT aft	(31) EC31 (Da) Direct without lug asym, t=10						0.5	0.0	90.0	1.8	1.8	355.0	0.0	
	fwd	(31) EC31 (Da) Direct without lug asym, t=10						0.5	0.0	90.0	1.8	1.8	355.0	0.0	
	YIELD aft	0.0	0.0	0.0	0.0	0.0	0.0	0.0	184.5	125.1	112.9	112.9	0.0	0.0	Yes
	fwd	0.0	0.0	0.0	0.0	0.0	0.0	0.0	184.5	125.1	112.9	112.9	0.0	0.0	
WELD aft	0.0	0.0	0.0	0.0	6.0	6.0	0.0	0.0	0.3	1.0	95.0	0.0		Yes	
fwd	0.0	0.0	0.0	0.0	6.0	6.0	0.0	0.0	0.3	1.0	95.0	0.0			
60	ACT aft	(31) EC31 (Da) Direct without lug asym, t=10						0.5	0.0	90.0	1.8	1.8	355.0	0.0	
	fwd	(31) EC31 (Da) Direct without lug asym, t=10						0.5	0.0	90.0	1.8	1.8	355.0	0.0	
	YIELD aft	0.0	0.0	0.0	0.0	0.0	0.0	0.0	184.5	125.0	112.8	112.8	0.0	0.0	Yes
	fwd	0.0	0.0	0.0	0.0	0.0	0.0	0.0	184.5	125.0	112.8	112.8	0.0	0.0	
WELD aft	0.0	0.0	0.0	0.0	6.0	6.0	0.0	0.0	0.3	1.0	95.0	0.0		Yes	
fwd	0.0	0.0	0.0	0.0	6.0	6.0	0.0	0.0	0.3	1.0	95.0	0.0			
61	ACT aft	(31) EC31 (Da) Direct without lug asym, t=10						0.5	0.0	90.0	1.8	1.8	355.0	0.0	
	fwd	(31) EC31 (Da) Direct without lug asym, t=10						0.5	0.0	90.0	1.8	1.8	355.0	0.0	
	YIELD aft	0.0	0.0	0.0	0.0	0.0	0.0	0.0	184.5	124.9	112.7	112.7	0.0	0.0	Yes
	fwd	0.0	0.0	0.0	0.0	0.0	0.0	0.0	184.5	124.9	112.7	112.7	0.0	0.0	
WELD aft	0.0	0.0	0.0	0.0	6.0	6.0	0.0	0.0	0.3	1.0	95.0	0.0		Yes	
fwd	0.0	0.0	0.0	0.0	6.0	6.0	0.0	0.0	0.3	1.0	95.0	0.0			
62	ACT aft	(31) EC31 (Da) Direct without lug asym, t=10						0.5	0.0	90.0	1.8	1.8	355.0	0.0	
	fwd	(31) EC31 (Da) Direct without lug asym, t=10						0.5	0.0	90.0	1.8	1.8	355.0	0.0	
	YIELD aft	0.0	0.0	0.0	0.0	0.0	0.0	0.0	184.5	124.8	112.6	112.6	0.0	0.0	Yes
	fwd	0.0	0.0	0.0	0.0	0.0	0.0	0.0	184.5	124.8	112.6	112.6	0.0	0.0	
WELD aft	0.0	0.0	0.0	0.0	6.0	6.0	0.0	0.0	0.3	1.0	95.0	0.0		Yes	
fwd	0.0	0.0	0.0	0.0	6.0	6.0	0.0	0.0	0.3	1.0	95.0	0.0			
63	ACT aft	(31) EC31 (Da) Direct without lug asym, t=10						0.5	0.0	90.0	1.8	1.8	355.0	0.0	
	fwd	(31) EC31 (Da) Direct without lug asym, t=10						0.5	0.0	90.0	1.8	1.8	355.0	0.0	
	YIELD aft	0.0	0.0	0.0	0.0	0.0	0.0	0.0	184.5	124.6	112.5	112.5	0.0	0.0	Yes
	fwd	0.0	0.0	0.0	0.0	0.0	0.0	0.0	184.5	124.6	112.5	112.5	0.0	0.0	
WELD aft	0.0	0.0	0.0	0.0	6.0	6.0	0.0	0.0	0.3	1.0	95.0	0.0		Yes	
fwd	0.0	0.0	0.0	0.0	6.0	6.0	0.0	0.0	0.3	1.0	95.0	0.0			

Strength Deck at #99

1	ACT aft	(31) EC31 (Da) Direct without lug asym, t=10						0.5	0.0	90.0	1.8	1.8	355.0	0.0	
	fwd	(31) EC31 (Da) Direct without lug asym, t=10						0.5	0.0	90.0	1.8	1.8	355.0	0.0	
	YIELD aft	0.0	0.0	0.0	0.0	0.0	0.0	0.0	145.5	5.1	2.7	2.7	0.0	0.0	Yes
	fwd	0.0	0.0	0.0	0.0	0.0	0.0	0.0	145.5	5.1	2.7	2.7	0.0	0.0	
WELD aft	0.0	0.0	0.0	0.0	4.0	6.0	0.0	0.0	0.3	1.0	0.0	0.0		Yes	
fwd	0.0	0.0	0.0	0.0	4.0	6.0	0.0	0.0	0.3	1.0	0.0	0.0			

ID	ACT aft fwd	End conn Shear conn						t _c PSM [mm]	t _c web stiff [mm]	PSM web angle φ _w [deg]	S1 [m]	S2 [m]	R _{eH} PSM [N/mm ²]	R _{eH} web stiff [N/mm ²]	OK?
		σ _w perm [N/mm ²]		σ _w [N/mm ²]		σ _{wc} perm [N/mm ²]									
WELD aft fwd	l _{leg} web stiff [mm]	l _{leg} brkt [mm]		l _{leg} direct [mm]		l _{leg} lug [mm]		f _{weld}	f _c	l _s [mm]	d _{we} [mm]			OK?	
		req	act	req	act	req	act								req
2	ACT aft	(31) EC31 (Da) Direct without lug asym, t=10						0.5	0.0	90.0	1.8	1.8	355.0	0.0	
	fwd	(31) EC31 (Da) Direct without lug asym, t=10						0.5	0.0	90.0	1.8	1.8	355.0	0.0	
	YIELD aft fwd	0.0	0.0	0.0	0.0	0.0	0.0	0.0	145.5	5.1	2.7	2.7	0.0	Yes	
	WELD aft fwd	0.0	0.0	0.0	0.0	4.0	6.0	0.0	0.0	0.3	1.0	0.0	0.0	Yes	
13	ACT aft	(31) EC31 (Da) Direct without lug asym, t=10						0.5	0.0	90.0	1.8	1.8	355.0	0.0	
	fwd	(31) EC31 (Da) Direct without lug asym, t=10						0.5	0.0	90.0	1.8	1.8	355.0	0.0	
	YIELD aft fwd	0.0	0.0	0.0	0.0	0.0	0.0	0.0	145.5	3.7	2.0	2.0	0.0	Yes	
	WELD aft fwd	0.0	0.0	0.0	0.0	4.0	6.0	0.0	0.0	0.3	1.0	0.0	0.0	Yes	
14	ACT aft	(31) EC31 (Da) Direct without lug asym, t=10						0.5	0.0	90.0	1.8	1.8	355.0	0.0	
	fwd	(31) EC31 (Da) Direct without lug asym, t=10						0.5	0.0	90.0	1.8	1.8	355.0	0.0	
	YIELD aft fwd	0.0	0.0	0.0	0.0	0.0	0.0	0.0	145.5	5.1	2.7	2.7	0.0	Yes	
	WELD aft fwd	0.0	0.0	0.0	0.0	4.0	6.0	0.0	0.0	0.3	1.0	0.0	0.0	Yes	
16	ACT aft	(31) EC31 (Da) Direct without lug asym, t=10						0.5	0.0	90.0	1.8	1.8	355.0	0.0	
	fwd	(31) EC31 (Da) Direct without lug asym, t=10						0.5	0.0	90.0	1.8	1.8	355.0	0.0	
	YIELD aft fwd	0.0	0.0	0.0	0.0	0.0	0.0	0.0	145.5	5.1	2.7	2.7	0.0	Yes	
	WELD aft fwd	0.0	0.0	0.0	0.0	4.0	6.0	0.0	0.0	0.3	1.0	0.0	0.0	Yes	
17	ACT aft	(31) EC31 (Da) Direct without lug asym, t=10						0.5	0.0	90.0	1.8	1.8	355.0	0.0	
	fwd	(31) EC31 (Da) Direct without lug asym, t=10						0.5	0.0	90.0	1.8	1.8	355.0	0.0	
	YIELD aft fwd	0.0	0.0	0.0	0.0	0.0	0.0	0.0	145.5	5.1	2.7	2.7	0.0	Yes	
	WELD aft fwd	0.0	0.0	0.0	0.0	4.0	6.0	0.0	0.0	0.3	1.0	0.0	0.0	Yes	
18	ACT aft	(31) EC31 (Da) Direct without lug asym, t=10						0.5	0.0	90.0	1.8	1.8	355.0	0.0	
	fwd	(31) EC31 (Da) Direct without lug asym, t=10						0.5	0.0	90.0	1.8	1.8	355.0	0.0	
	YIELD aft fwd	0.0	0.0	0.0	0.0	0.0	0.0	0.0	145.5	5.1	2.7	2.7	0.0	Yes	
	WELD aft fwd	0.0	0.0	0.0	0.0	4.0	6.0	0.0	0.0	0.3	1.0	0.0	0.0	Yes	
19	ACT aft	(31) EC31 (Da) Direct without lug asym, t=10						0.5	0.0	90.0	1.8	1.8	355.0	0.0	
	fwd	(31) EC31 (Da) Direct without lug asym, t=10						0.5	0.0	90.0	1.8	1.8	355.0	0.0	
	YIELD aft fwd	0.0	0.0	0.0	0.0	0.0	0.0	0.0	145.5	5.1	2.7	2.7	0.0	Yes	
	WELD aft fwd	0.0	0.0	0.0	0.0	4.0	6.0	0.0	0.0	0.3	1.0	0.0	0.0	Yes	
20	ACT aft	(31) EC31 (Da) Direct without lug asym, t=10						0.5	0.0	90.0	1.8	1.8	355.0	0.0	
	fwd	(31) EC31 (Da) Direct without lug asym, t=10						0.5	0.0	90.0	1.8	1.8	355.0	0.0	
	YIELD aft fwd	0.0	0.0	0.0	0.0	0.0	0.0	0.0	145.5	5.1	2.7	2.7	0.0	Yes	
	WELD aft fwd	0.0	0.0	0.0	0.0	4.0	6.0	0.0	0.0	0.3	1.0	0.0	0.0	Yes	
21	ACT aft	(31) EC31 (Da) Direct without lug asym, t=10						0.5	0.0	90.0	1.8	1.8	355.0	0.0	
	fwd	(31) EC31 (Da) Direct without lug asym, t=10						0.5	0.0	90.0	1.8	1.8	355.0	0.0	
	YIELD aft fwd	0.0	0.0	0.0	0.0	0.0	0.0	0.0	145.5	5.1	2.7	2.7	0.0	Yes	
	WELD aft fwd	0.0	0.0	0.0	0.0	4.0	6.0	0.0	0.0	0.3	1.0	0.0	0.0	Yes	

ID	ACT aft fwd	End conn Shear conn						t _c PSM [mm]	t _c web stiff [mm]	PSM web angle φ _w [deg]	S1 [m]	S2 [m]	R _{eH} PSM [N/mm ²]	R _{eH} web stiff [N/mm ²]	OK?
		σ _w perm [N/mm ²]		σ _w [N/mm ²]		σ _{wc} perm [N/mm ²]									
WELD aft fwd	l _{leg} web stiff [mm]	l _{leg} brkt [mm]		l _{leg} direct [mm]		l _{leg} lug [mm]		f _{weld}	f _c	l _s [mm]	d _{wc} [mm]	OK?			
		req	act	req	act	req	act						req	act	
22	ACT aft	(31) EC31 (Da) Direct without lug asym, t=10						0.5	0.0	90.0	1.8	1.8	355.0	0.0	
	fwd	(31) EC31 (Da) Direct without lug asym, t=10						0.5	0.0	90.0	1.8	1.8	355.0	0.0	
	YIELD aft	0.0	0.0	0.0	0.0	0.0	0.0	0.0	145.5	5.1	2.7	2.7	0.0	Yes	
	fwd	0.0	0.0	0.0	0.0	0.0	0.0	0.0	145.5	5.1	2.7	2.7	0.0		
WELD aft	0.0	0.0	0.0	0.0	4.0	6.0	0.0	0.0	0.3	1.0	0.0	0.0	Yes		
fwd	0.0	0.0	0.0	0.0	4.0	6.0	0.0	0.0	0.3	1.0	0.0	0.0			
24	ACT aft	(31) EC31 (Da) Direct without lug asym, t=10						0.5	0.0	90.0	1.8	1.8	355.0	0.0	
	fwd	(31) EC31 (Da) Direct without lug asym, t=10						0.5	0.0	90.0	1.8	1.8	355.0	0.0	
	YIELD aft	0.0	0.0	0.0	0.0	0.0	0.0	0.0	145.5	5.1	2.7	2.7	0.0	Yes	
	fwd	0.0	0.0	0.0	0.0	0.0	0.0	0.0	145.5	5.1	2.7	2.7	0.0		
WELD aft	0.0	0.0	0.0	0.0	4.0	6.0	0.0	0.0	0.3	1.0	0.0	0.0	Yes		
fwd	0.0	0.0	0.0	0.0	4.0	6.0	0.0	0.0	0.3	1.0	0.0	0.0			
3	ACT aft	(31) EC31 (Da) Direct without lug asym, t=10						0.5	0.0	90.0	1.8	1.8	355.0	0.0	
	fwd	(31) EC31 (Da) Direct without lug asym, t=10						0.5	0.0	90.0	1.8	1.8	355.0	0.0	
	YIELD aft	0.0	0.0	0.0	0.0	0.0	0.0	0.0	145.5	5.1	2.7	2.7	0.0	Yes	
	fwd	0.0	0.0	0.0	0.0	0.0	0.0	0.0	145.5	5.1	2.7	2.7	0.0		
WELD aft	0.0	0.0	0.0	0.0	4.0	6.0	0.0	0.0	0.3	1.0	0.0	0.0	Yes		
fwd	0.0	0.0	0.0	0.0	4.0	6.0	0.0	0.0	0.3	1.0	0.0	0.0			
25	ACT aft	(31) EC31 (Da) Direct without lug asym, t=10						0.5	0.0	90.0	1.8	1.8	355.0	0.0	
	fwd	(31) EC31 (Da) Direct without lug asym, t=10						0.5	0.0	90.0	1.8	1.8	355.0	0.0	
	YIELD aft	0.0	0.0	0.0	0.0	0.0	0.0	0.0	145.5	5.1	2.7	2.7	0.0	Yes	
	fwd	0.0	0.0	0.0	0.0	0.0	0.0	0.0	145.5	5.1	2.7	2.7	0.0		
WELD aft	0.0	0.0	0.0	0.0	4.0	6.0	0.0	0.0	0.3	1.0	0.0	0.0	Yes		
fwd	0.0	0.0	0.0	0.0	4.0	6.0	0.0	0.0	0.3	1.0	0.0	0.0			
26	ACT aft	(31) EC31 (Da) Direct without lug asym, t=10						0.5	0.0	90.0	1.8	1.8	355.0	0.0	
	fwd	(31) EC31 (Da) Direct without lug asym, t=10						0.5	0.0	90.0	1.8	1.8	355.0	0.0	
	YIELD aft	0.0	0.0	0.0	0.0	0.0	0.0	0.0	145.5	5.1	2.7	2.7	0.0	Yes	
	fwd	0.0	0.0	0.0	0.0	0.0	0.0	0.0	145.5	5.1	2.7	2.7	0.0		
WELD aft	0.0	0.0	0.0	0.0	4.0	6.0	0.0	0.0	0.3	1.0	0.0	0.0	Yes		
fwd	0.0	0.0	0.0	0.0	4.0	6.0	0.0	0.0	0.3	1.0	0.0	0.0			
4	ACT aft	(31) EC31 (Da) Direct without lug asym, t=10						0.5	0.0	90.0	1.8	1.8	355.0	0.0	
	fwd	(31) EC31 (Da) Direct without lug asym, t=10						0.5	0.0	90.0	1.8	1.8	355.0	0.0	
	YIELD aft	0.0	0.0	0.0	0.0	0.0	0.0	0.0	145.5	5.1	2.7	2.7	0.0	Yes	
	fwd	0.0	0.0	0.0	0.0	0.0	0.0	0.0	145.5	5.1	2.7	2.7	0.0		
WELD aft	0.0	0.0	0.0	0.0	4.0	6.0	0.0	0.0	0.3	1.0	0.0	0.0	Yes		
fwd	0.0	0.0	0.0	0.0	4.0	6.0	0.0	0.0	0.3	1.0	0.0	0.0			
6	ACT aft	(31) EC31 (Da) Direct without lug asym, t=10						0.5	0.0	90.0	1.8	1.8	355.0	0.0	
	fwd	(31) EC31 (Da) Direct without lug asym, t=10						0.5	0.0	90.0	1.8	1.8	355.0	0.0	
	YIELD aft	0.0	0.0	0.0	0.0	0.0	0.0	0.0	145.5	5.1	2.7	2.7	0.0	Yes	
	fwd	0.0	0.0	0.0	0.0	0.0	0.0	0.0	145.5	5.1	2.7	2.7	0.0		
WELD aft	0.0	0.0	0.0	0.0	4.0	6.0	0.0	0.0	0.3	1.0	0.0	0.0	Yes		
fwd	0.0	0.0	0.0	0.0	4.0	6.0	0.0	0.0	0.3	1.0	0.0	0.0			
7	ACT aft	(31) EC31 (Da) Direct without lug asym, t=10						0.5	0.0	90.0	1.8	1.8	355.0	0.0	
	fwd	(31) EC31 (Da) Direct without lug asym, t=10						0.5	0.0	90.0	1.8	1.8	355.0	0.0	
	YIELD aft	0.0	0.0	0.0	0.0	0.0	0.0	0.0	145.5	5.1	2.7	2.7	0.0	Yes	
	fwd	0.0	0.0	0.0	0.0	0.0	0.0	0.0	145.5	5.1	2.7	2.7	0.0		
WELD aft	0.0	0.0	0.0	0.0	4.0	6.0	0.0	0.0	0.3	1.0	0.0	0.0	Yes		
fwd	0.0	0.0	0.0	0.0	4.0	6.0	0.0	0.0	0.3	1.0	0.0	0.0			
8	ACT aft	(31) EC31 (Da) Direct without lug asym, t=10						0.5	0.0	90.0	1.8	1.8	355.0	0.0	
	fwd	(31) EC31 (Da) Direct without lug asym, t=10						0.5	0.0	90.0	1.8	1.8	355.0	0.0	
	YIELD aft	0.0	0.0	0.0	0.0	0.0	0.0	0.0	145.5	5.1	2.7	2.7	0.0	Yes	
	fwd	0.0	0.0	0.0	0.0	0.0	0.0	0.0	145.5	5.1	2.7	2.7	0.0		
WELD aft	0.0	0.0	0.0	0.0	4.0	6.0	0.0	0.0	0.3	1.0	0.0	0.0	Yes		
fwd	0.0	0.0	0.0	0.0	4.0	6.0	0.0	0.0	0.3	1.0	0.0	0.0			

ID	ACT aft fwd	End conn Shear conn						t _c PSM [mm]	t _c web stiff [mm]	PSM web angle φ _w [deg]	S1 [m]	S2 [m]	R _{eH} PSM [N/mm ²]	R _{eH} web stiff [N/mm ²]	OK?
		σ _w perm [N/mm ²]		σ _w [N/mm ²]		σ _{wc} perm [N/mm ²]									
WELD aft fwd	l _{leg} web stiff [mm]	l _{leg} brkt [mm]		l _{leg} direct [mm]		l _{leg} lug [mm]		f _{weld}	f _c	l _s [mm]	d _{we} [mm]	OK?			
		req	act	req	act	req	act						req	act	
10	ACT aft	(31) EC31 (Da) Direct without lug asym, t=10						0.5	0.0	90.0	1.8	1.8	355.0	0.0	
	fwd	(31) EC31 (Da) Direct without lug asym, t=10						0.5	0.0	90.0	1.8	1.8	355.0	0.0	
	YIELD aft	0.0	0.0	0.0	0.0	0.0	0.0	0.0	145.5	5.1	2.7	2.7	0.0	Yes	
	fwd	0.0	0.0	0.0	0.0	0.0	0.0	0.0	145.5	5.1	2.7	2.7	0.0		
	WELD aft	0.0	0.0	0.0	0.0	4.0	6.0	0.0	0.3	1.0	0.0	0.0		Yes	
	fwd	0.0	0.0	0.0	0.0	4.0	6.0	0.0	0.3	1.0	0.0	0.0			
11	ACT aft	(31) EC31 (Da) Direct without lug asym, t=10						0.5	0.0	90.0	1.8	1.8	355.0	0.0	
	fwd	(31) EC31 (Da) Direct without lug asym, t=10						0.5	0.0	90.0	1.8	1.8	355.0	0.0	
	YIELD aft	0.0	0.0	0.0	0.0	0.0	0.0	0.0	145.5	5.1	2.7	2.7	0.0	Yes	
	fwd	0.0	0.0	0.0	0.0	0.0	0.0	0.0	145.5	5.1	2.7	2.7	0.0		
	WELD aft	0.0	0.0	0.0	0.0	4.0	6.0	0.0	0.3	1.0	0.0	0.0		Yes	
	fwd	0.0	0.0	0.0	0.0	4.0	6.0	0.0	0.3	1.0	0.0	0.0			
12	ACT aft	(31) EC31 (Da) Direct without lug asym, t=10						0.5	0.0	90.0	1.8	1.8	355.0	0.0	
	fwd	(31) EC31 (Da) Direct without lug asym, t=10						0.5	0.0	90.0	1.8	1.8	355.0	0.0	
	YIELD aft	0.0	0.0	0.0	0.0	0.0	0.0	0.0	145.5	4.2	2.2	2.2	0.0	Yes	
	fwd	0.0	0.0	0.0	0.0	0.0	0.0	0.0	145.5	4.2	2.2	2.2	0.0		
	WELD aft	0.0	0.0	0.0	0.0	4.0	6.0	0.0	0.3	1.0	0.0	0.0		Yes	
	fwd	0.0	0.0	0.0	0.0	4.0	6.0	0.0	0.3	1.0	0.0	0.0			

Deck_4800_4800 at #99

38	ACT aft	(31) EC31 (Da) Direct without lug asym, t=10						1.5	0.0	90.0	1.8	1.8	355.0	0.0	
	fwd	(31) EC31 (Da) Direct without lug asym, t=10						1.5	0.0	90.0	1.8	1.8	355.0	0.0	
	YIELD aft	0.0	0.0	0.0	0.0	0.0	0.0	0.0	145.5	6.8	4.3	4.3	0.0	Yes	
	fwd	0.0	0.0	0.0	0.0	0.0	0.0	0.0	145.5	6.8	4.3	4.3	0.0		
	WELD aft	0.0	0.0	0.0	0.0	4.0	6.0	0.0	0.3	1.0	0.0	0.0		Yes	
	fwd	0.0	0.0	0.0	0.0	4.0	6.0	0.0	0.3	1.0	0.0	0.0			
39	ACT aft	(31) EC31 (Da) Direct without lug asym, t=10						1.5	0.0	90.0	1.8	1.8	355.0	0.0	
	fwd	(31) EC31 (Da) Direct without lug asym, t=10						1.5	0.0	90.0	1.8	1.8	355.0	0.0	
	YIELD aft	0.0	0.0	0.0	0.0	0.0	0.0	0.0	145.5	9.5	6.1	6.1	0.0	Yes	
	fwd	0.0	0.0	0.0	0.0	0.0	0.0	0.0	145.5	9.5	6.1	6.1	0.0		
	WELD aft	0.0	0.0	0.0	0.0	4.0	6.0	0.0	0.3	1.0	0.0	0.0		Yes	
	fwd	0.0	0.0	0.0	0.0	4.0	6.0	0.0	0.3	1.0	0.0	0.0			
50	ACT aft	(31) EC31 (Da) Direct without lug asym, t=10						1.5	0.0	90.0	1.8	1.8	355.0	0.0	
	fwd	(31) EC31 (Da) Direct without lug asym, t=10						1.5	0.0	90.0	1.8	1.8	355.0	0.0	
	YIELD aft	0.0	0.0	0.0	0.0	0.0	0.0	0.0	145.5	9.5	6.1	6.1	0.0	Yes	
	fwd	0.0	0.0	0.0	0.0	0.0	0.0	0.0	145.5	9.5	6.1	6.1	0.0		
	WELD aft	0.0	0.0	0.0	0.0	4.0	6.0	0.0	0.3	1.0	0.0	0.0		Yes	
	fwd	0.0	0.0	0.0	0.0	4.0	6.0	0.0	0.3	1.0	0.0	0.0			
51	ACT aft	(31) EC31 (Da) Direct without lug asym, t=10						1.5	0.0	90.0	1.8	1.8	355.0	0.0	
	fwd	(31) EC31 (Da) Direct without lug asym, t=10						1.5	0.0	90.0	1.8	1.8	355.0	0.0	
	YIELD aft	0.0	0.0	0.0	0.0	0.0	0.0	0.0	145.5	9.5	6.1	6.1	0.0	Yes	
	fwd	0.0	0.0	0.0	0.0	0.0	0.0	0.0	145.5	9.5	6.1	6.1	0.0		
	WELD aft	0.0	0.0	0.0	0.0	4.0	6.0	0.0	0.3	1.0	0.0	0.0		Yes	
	fwd	0.0	0.0	0.0	0.0	4.0	6.0	0.0	0.3	1.0	0.0	0.0			
52	ACT aft	(31) EC31 (Da) Direct without lug asym, t=10						1.5	0.0	90.0	1.8	1.8	355.0	0.0	
	fwd	(31) EC31 (Da) Direct without lug asym, t=10						1.5	0.0	90.0	1.8	1.8	355.0	0.0	
	YIELD aft	0.0	0.0	0.0	0.0	0.0	0.0	0.0	145.5	9.5	6.1	6.1	0.0	Yes	
	fwd	0.0	0.0	0.0	0.0	0.0	0.0	0.0	145.5	9.5	6.1	6.1	0.0		
	WELD aft	0.0	0.0	0.0	0.0	4.0	6.0	0.0	0.3	1.0	0.0	0.0		Yes	
	fwd	0.0	0.0	0.0	0.0	4.0	6.0	0.0	0.3	1.0	0.0	0.0			

ID	ACT aft fwd	End conn Shear conn						t _c PSM [mm]	t _c web stiff [mm]	PSM web angle φ _w [deg]	S1 [m]	S2 [m]	R _{eH} PSM [N/mm ²]	R _{eH} web stiff [N/mm ²]	OK?
		σ _w perm [N/mm ²]		σ _w [N/mm ²]		σ _{wc} perm [N/mm ²]									
WELD aft fwd	l _{leg} web stiff [mm]	l _{leg} brkt [mm]		l _{leg} direct [mm]		l _{leg} lug [mm]		f _{weld}	f _c	l _s [mm]	d _{wc} [mm]			OK?	
		req	act	req	act	req	act								req
53	ACT aft	(31) EC31 (Da) Direct without lug asym, t=10						1.5	0.0	90.0	1.8	1.8	355.0	0.0	
	fwd	(31) EC31 (Da) Direct without lug asym, t=10						1.5	0.0	90.0	1.8	1.8	355.0	0.0	
	YIELD aft	0.0	0.0	0.0	0.0	0.0	0.0	0.0	145.5	9.5	6.1	6.1	0.0	Yes	
	fwd	0.0	0.0	0.0	0.0	0.0	0.0	0.0	145.5	9.5	6.1	6.1	0.0		
	WELD aft	0.0	0.0	0.0	0.0	4.0	6.0	0.0	0.3	1.0	0.0	0.0		Yes	
	fwd	0.0	0.0	0.0	0.0	4.0	6.0	0.0	0.3	1.0	0.0	0.0			
40	ACT aft	(31) EC31 (Da) Direct without lug asym, t=10						1.5	0.0	90.0	1.8	1.8	355.0	0.0	
	fwd	(31) EC31 (Da) Direct without lug asym, t=10						1.5	0.0	90.0	1.8	1.8	355.0	0.0	
	YIELD aft	0.0	0.0	0.0	0.0	0.0	0.0	0.0	145.5	9.5	6.1	6.1	0.0	Yes	
	fwd	0.0	0.0	0.0	0.0	0.0	0.0	0.0	145.5	9.5	6.1	6.1	0.0		
	WELD aft	0.0	0.0	0.0	0.0	4.0	6.0	0.0	0.3	1.0	0.0	0.0		Yes	
	fwd	0.0	0.0	0.0	0.0	4.0	6.0	0.0	0.3	1.0	0.0	0.0			
43	ACT aft	(31) EC31 (Da) Direct without lug asym, t=10						1.5	0.0	90.0	1.8	1.8	355.0	0.0	
	fwd	(31) EC31 (Da) Direct without lug asym, t=10						1.5	0.0	90.0	1.8	1.8	355.0	0.0	
	YIELD aft	0.0	0.0	0.0	0.0	0.0	0.0	0.0	145.5	7.9	5.0	5.0	0.0	Yes	
	fwd	0.0	0.0	0.0	0.0	0.0	0.0	0.0	145.5	7.9	5.0	5.0	0.0		
	WELD aft	0.0	0.0	0.0	0.0	4.0	6.0	0.0	0.3	1.0	0.0	0.0		Yes	
	fwd	0.0	0.0	0.0	0.0	4.0	6.0	0.0	0.3	1.0	0.0	0.0			
44	ACT aft	(31) EC31 (Da) Direct without lug asym, t=10						1.5	0.0	90.0	1.8	1.8	355.0	0.0	
	fwd	(31) EC31 (Da) Direct without lug asym, t=10						1.5	0.0	90.0	1.8	1.8	355.0	0.0	
	YIELD aft	0.0	0.0	0.0	0.0	0.0	0.0	0.0	145.5	7.0	4.5	4.5	0.0	Yes	
	fwd	0.0	0.0	0.0	0.0	0.0	0.0	0.0	145.5	7.0	4.5	4.5	0.0		
	WELD aft	0.0	0.0	0.0	0.0	4.0	6.0	0.0	0.3	1.0	0.0	0.0		Yes	
	fwd	0.0	0.0	0.0	0.0	4.0	6.0	0.0	0.3	1.0	0.0	0.0			
45	ACT aft	(31) EC31 (Da) Direct without lug asym, t=10						1.5	0.0	90.0	1.8	1.8	355.0	0.0	
	fwd	(31) EC31 (Da) Direct without lug asym, t=10						1.5	0.0	90.0	1.8	1.8	355.0	0.0	
	YIELD aft	0.0	0.0	0.0	0.0	0.0	0.0	0.0	145.5	9.5	6.1	6.1	0.0	Yes	
	fwd	0.0	0.0	0.0	0.0	0.0	0.0	0.0	145.5	9.5	6.1	6.1	0.0		
	WELD aft	0.0	0.0	0.0	0.0	4.0	6.0	0.0	0.3	1.0	0.0	0.0		Yes	
	fwd	0.0	0.0	0.0	0.0	4.0	6.0	0.0	0.3	1.0	0.0	0.0			
46	ACT aft	(31) EC31 (Da) Direct without lug asym, t=10						1.5	0.0	90.0	1.8	1.8	355.0	0.0	
	fwd	(31) EC31 (Da) Direct without lug asym, t=10						1.5	0.0	90.0	1.8	1.8	355.0	0.0	
	YIELD aft	0.0	0.0	0.0	0.0	0.0	0.0	0.0	145.5	9.5	6.1	6.1	0.0	Yes	
	fwd	0.0	0.0	0.0	0.0	0.0	0.0	0.0	145.5	9.5	6.1	6.1	0.0		
	WELD aft	0.0	0.0	0.0	0.0	4.0	6.0	0.0	0.3	1.0	0.0	0.0		Yes	
	fwd	0.0	0.0	0.0	0.0	4.0	6.0	0.0	0.3	1.0	0.0	0.0			
47	ACT aft	(31) EC31 (Da) Direct without lug asym, t=10						1.5	0.0	90.0	1.8	1.8	355.0	0.0	
	fwd	(31) EC31 (Da) Direct without lug asym, t=10						1.5	0.0	90.0	1.8	1.8	355.0	0.0	
	YIELD aft	0.0	0.0	0.0	0.0	0.0	0.0	0.0	145.5	9.5	6.1	6.1	0.0	Yes	
	fwd	0.0	0.0	0.0	0.0	0.0	0.0	0.0	145.5	9.5	6.1	6.1	0.0		
	WELD aft	0.0	0.0	0.0	0.0	4.0	6.0	0.0	0.3	1.0	0.0	0.0		Yes	
	fwd	0.0	0.0	0.0	0.0	4.0	6.0	0.0	0.3	1.0	0.0	0.0			
48	ACT aft	(31) EC31 (Da) Direct without lug asym, t=10						1.5	0.0	90.0	1.8	1.8	355.0	0.0	
	fwd	(31) EC31 (Da) Direct without lug asym, t=10						1.5	0.0	90.0	1.8	1.8	355.0	0.0	
	YIELD aft	0.0	0.0	0.0	0.0	0.0	0.0	0.0	145.5	9.5	6.1	6.1	0.0	Yes	
	fwd	0.0	0.0	0.0	0.0	0.0	0.0	0.0	145.5	9.5	6.1	6.1	0.0		
	WELD aft	0.0	0.0	0.0	0.0	4.0	6.0	0.0	0.3	1.0	0.0	0.0		Yes	
	fwd	0.0	0.0	0.0	0.0	4.0	6.0	0.0	0.3	1.0	0.0	0.0			
49	ACT aft	(31) EC31 (Da) Direct without lug asym, t=10						1.5	0.0	90.0	1.8	1.8	355.0	0.0	
	fwd	(31) EC31 (Da) Direct without lug asym, t=10						1.5	0.0	90.0	1.8	1.8	355.0	0.0	
	YIELD aft	0.0	0.0	0.0	0.0	0.0	0.0	0.0	145.5	9.5	6.1	6.1	0.0	Yes	
	fwd	0.0	0.0	0.0	0.0	0.0	0.0	0.0	145.5	9.5	6.1	6.1	0.0		
	WELD aft	0.0	0.0	0.0	0.0	4.0	6.0	0.0	0.3	1.0	0.0	0.0		Yes	
	fwd	0.0	0.0	0.0	0.0	4.0	6.0	0.0	0.3	1.0	0.0	0.0			

ID	ACT aft fwd	End conn Shear conn						t _c PSM [mm]	t _c web stiff [mm]	PSM web angle φ _w [deg]	S1 [m]	S2 [m]	R _{eH} PSM [N/mm ²]	R _{eH} web stiff [N/mm ²]	OK?
		σ _w perm [N/mm ²]		σ _w [N/mm ²]		σ _{wc} perm [N/mm ²]									
WELD aft fwd	l _{leg} web stiff [mm]	l _{leg} brkt [mm]		l _{leg} direct [mm]		l _{leg} lug [mm]		f _{weld}	f _c	l _s [mm]	d _{wc} [mm]			OK?	
		req	act	req	act	req	act								req

Deck_8100_8100 at #99

27	ACT aft	(31) EC31 (Da) Direct without lug asym, t=10						1.5	0.0	90.0	1.8	1.8	355.0	0.0	
	fwd	(31) EC31 (Da) Direct without lug asym, t=10						1.5	0.0	90.0	1.8	1.8	355.0	0.0	
	YIELD aft	0.0	0.0	0.0	0.0	0.0	0.0	0.0	145.5	3.0	1.9	1.9	0.0	Yes	
	fwd	0.0	0.0	0.0	0.0	0.0	0.0	0.0	145.5	3.0	1.9	1.9	0.0		
WELD aft	0.0	0.0	0.0	0.0	4.0	6.0	0.0	0.0	0.3	1.0	0.0	0.0	Yes		
fwd	0.0	0.0	0.0	0.0	4.0	6.0	0.0	0.0	0.3	1.0	0.0	0.0			
19	ACT aft	(31) EC31 (Da) Direct without lug asym, t=10						1.5	0.0	90.0	1.8	1.8	355.0	0.0	
	fwd	(31) EC31 (Da) Direct without lug asym, t=10						1.5	0.0	90.0	1.8	1.8	355.0	0.0	
	YIELD aft	0.0	0.0	0.0	0.0	0.0	0.0	0.0	145.5	3.0	1.9	1.9	0.0	Yes	
	fwd	0.0	0.0	0.0	0.0	0.0	0.0	0.0	145.5	3.0	1.9	1.9	0.0		
WELD aft	0.0	0.0	0.0	0.0	4.0	6.0	0.0	0.0	0.3	1.0	0.0	0.0	Yes		
fwd	0.0	0.0	0.0	0.0	4.0	6.0	0.0	0.0	0.3	1.0	0.0	0.0			
32	ACT aft	(31) EC31 (Da) Direct without lug asym, t=10						1.5	0.0	90.0	1.8	1.8	355.0	0.0	
	fwd	(31) EC31 (Da) Direct without lug asym, t=10						1.5	0.0	90.0	1.8	1.8	355.0	0.0	
	YIELD aft	0.0	0.0	0.0	0.0	0.0	0.0	0.0	145.5	2.2	1.4	1.4	0.0	Yes	
	fwd	0.0	0.0	0.0	0.0	0.0	0.0	0.0	145.5	2.2	1.4	1.4	0.0		
WELD aft	0.0	0.0	0.0	0.0	4.0	6.0	0.0	0.0	0.3	1.0	0.0	0.0	Yes		
fwd	0.0	0.0	0.0	0.0	4.0	6.0	0.0	0.0	0.3	1.0	0.0	0.0			
33	ACT aft	(31) EC31 (Da) Direct without lug asym, t=10						1.5	0.0	90.0	1.8	1.8	355.0	0.0	
	fwd	(31) EC31 (Da) Direct without lug asym, t=10						1.5	0.0	90.0	1.8	1.8	355.0	0.0	
	YIELD aft	0.0	0.0	0.0	0.0	0.0	0.0	0.0	145.5	3.0	1.9	1.9	0.0	Yes	
	fwd	0.0	0.0	0.0	0.0	0.0	0.0	0.0	145.5	3.0	1.9	1.9	0.0		
WELD aft	0.0	0.0	0.0	0.0	4.0	6.0	0.0	0.0	0.3	1.0	0.0	0.0	Yes		
fwd	0.0	0.0	0.0	0.0	4.0	6.0	0.0	0.0	0.3	1.0	0.0	0.0			
35	ACT aft	(31) EC31 (Da) Direct without lug asym, t=10						1.5	0.0	90.0	1.8	1.8	355.0	0.0	
	fwd	(31) EC31 (Da) Direct without lug asym, t=10						1.5	0.0	90.0	1.8	1.8	355.0	0.0	
	YIELD aft	0.0	0.0	0.0	0.0	0.0	0.0	0.0	145.5	3.0	1.9	1.9	0.0	Yes	
	fwd	0.0	0.0	0.0	0.0	0.0	0.0	0.0	145.5	3.0	1.9	1.9	0.0		
WELD aft	0.0	0.0	0.0	0.0	4.0	6.0	0.0	0.0	0.3	1.0	0.0	0.0	Yes		
fwd	0.0	0.0	0.0	0.0	4.0	6.0	0.0	0.0	0.3	1.0	0.0	0.0			
36	ACT aft	(31) EC31 (Da) Direct without lug asym, t=10						1.5	0.0	90.0	1.8	1.8	355.0	0.0	
	fwd	(31) EC31 (Da) Direct without lug asym, t=10						1.5	0.0	90.0	1.8	1.8	355.0	0.0	
	YIELD aft	0.0	0.0	0.0	0.0	0.0	0.0	0.0	145.5	3.0	1.9	1.9	0.0	Yes	
	fwd	0.0	0.0	0.0	0.0	0.0	0.0	0.0	145.5	3.0	1.9	1.9	0.0		
WELD aft	0.0	0.0	0.0	0.0	4.0	6.0	0.0	0.0	0.3	1.0	0.0	0.0	Yes		
fwd	0.0	0.0	0.0	0.0	4.0	6.0	0.0	0.0	0.3	1.0	0.0	0.0			
37	ACT aft	(31) EC31 (Da) Direct without lug asym, t=10						1.5	0.0	90.0	1.8	1.8	355.0	0.0	
	fwd	(31) EC31 (Da) Direct without lug asym, t=10						1.5	0.0	90.0	1.8	1.8	355.0	0.0	
	YIELD aft	0.0	0.0	0.0	0.0	0.0	0.0	0.0	145.5	3.0	1.9	1.9	0.0	Yes	
	fwd	0.0	0.0	0.0	0.0	0.0	0.0	0.0	145.5	3.0	1.9	1.9	0.0		
WELD aft	0.0	0.0	0.0	0.0	4.0	6.0	0.0	0.0	0.3	1.0	0.0	0.0	Yes		
fwd	0.0	0.0	0.0	0.0	4.0	6.0	0.0	0.0	0.3	1.0	0.0	0.0			
38	ACT aft	(31) EC31 (Da) Direct without lug asym, t=10						1.5	0.0	90.0	1.8	1.8	355.0	0.0	
	fwd	(31) EC31 (Da) Direct without lug asym, t=10						1.5	0.0	90.0	1.8	1.8	355.0	0.0	
	YIELD aft	0.0	0.0	0.0	0.0	0.0	0.0	0.0	145.5	3.0	1.9	1.9	0.0	Yes	
	fwd	0.0	0.0	0.0	0.0	0.0	0.0	0.0	145.5	3.0	1.9	1.9	0.0		
WELD aft	0.0	0.0	0.0	0.0	4.0	6.0	0.0	0.0	0.3	1.0	0.0	0.0	Yes		
fwd	0.0	0.0	0.0	0.0	4.0	6.0	0.0	0.0	0.3	1.0	0.0	0.0			

ID	ACT aft fwd	End conn Shear conn						t _c PSM [mm]	t _c web stiff [mm]	PSM web angle φ _w [deg]	S1 [m]	S2 [m]	R _{eH} PSM [N/mm ²]	R _{eH} web stiff [N/mm ²]	OK?
		σ _w perm [N/mm ²]		σ _w [N/mm ²]		σ _{wc} perm [N/mm ²]									
WELD aft fwd	l _{leg} web stiff [mm]	l _{leg} brkt [mm]		l _{leg} direct [mm]		l _{leg} lug [mm]		f _{weld}	f _c	l _s [mm]	d _{wc} [mm]			OK?	
		req	act	req	act	req	act								req
39	ACT aft	(31) EC31 (Da) Direct without lug asym, t=10						1.5	0.0	90.0	1.8	1.8	355.0	0.0	
	fwd	(31) EC31 (Da) Direct without lug asym, t=10						1.5	0.0	90.0	1.8	1.8	355.0	0.0	
	YIELD aft	0.0	0.0	0.0	0.0	0.0	0.0	0.0	145.5	3.0	1.9	1.9	0.0	Yes	
	fwd	0.0	0.0	0.0	0.0	0.0	0.0	0.0	145.5	3.0	1.9	1.9	0.0		
WELD aft	0.0	0.0	0.0	0.0	4.0	6.0	0.0	0.0	0.3	1.0	0.0	0.0	Yes		
fwd	0.0	0.0	0.0	0.0	4.0	6.0	0.0	0.0	0.3	1.0	0.0	0.0			
40	ACT aft	(31) EC31 (Da) Direct without lug asym, t=10						1.5	0.0	90.0	1.8	1.8	355.0	0.0	
	fwd	(31) EC31 (Da) Direct without lug asym, t=10						1.5	0.0	90.0	1.8	1.8	355.0	0.0	
	YIELD aft	0.0	0.0	0.0	0.0	0.0	0.0	0.0	145.5	3.0	1.9	1.9	0.0	Yes	
	fwd	0.0	0.0	0.0	0.0	0.0	0.0	0.0	145.5	3.0	1.9	1.9	0.0		
WELD aft	0.0	0.0	0.0	0.0	4.0	6.0	0.0	0.0	0.3	1.0	0.0	0.0	Yes		
fwd	0.0	0.0	0.0	0.0	4.0	6.0	0.0	0.0	0.3	1.0	0.0	0.0			
41	ACT aft	(31) EC31 (Da) Direct without lug asym, t=10						1.5	0.0	90.0	1.8	1.8	355.0	0.0	
	fwd	(31) EC31 (Da) Direct without lug asym, t=10						1.5	0.0	90.0	1.8	1.8	355.0	0.0	
	YIELD aft	0.0	0.0	0.0	0.0	0.0	0.0	0.0	145.5	3.0	1.9	1.9	0.0	Yes	
	fwd	0.0	0.0	0.0	0.0	0.0	0.0	0.0	145.5	3.0	1.9	1.9	0.0		
WELD aft	0.0	0.0	0.0	0.0	4.0	6.0	0.0	0.0	0.3	1.0	0.0	0.0	Yes		
fwd	0.0	0.0	0.0	0.0	4.0	6.0	0.0	0.0	0.3	1.0	0.0	0.0			
43	ACT aft	(31) EC31 (Da) Direct without lug asym, t=10						1.5	0.0	90.0	1.8	1.8	355.0	0.0	
	fwd	(31) EC31 (Da) Direct without lug asym, t=10						1.5	0.0	90.0	1.8	1.8	355.0	0.0	
	YIELD aft	0.0	0.0	0.0	0.0	0.0	0.0	0.0	145.5	3.0	1.9	1.9	0.0	Yes	
	fwd	0.0	0.0	0.0	0.0	0.0	0.0	0.0	145.5	3.0	1.9	1.9	0.0		
WELD aft	0.0	0.0	0.0	0.0	4.0	6.0	0.0	0.0	0.3	1.0	0.0	0.0	Yes		
fwd	0.0	0.0	0.0	0.0	4.0	6.0	0.0	0.0	0.3	1.0	0.0	0.0			
20	ACT aft	(31) EC31 (Da) Direct without lug asym, t=10						1.5	0.0	90.0	1.8	1.8	355.0	0.0	
	fwd	(31) EC31 (Da) Direct without lug asym, t=10						1.5	0.0	90.0	1.8	1.8	355.0	0.0	
	YIELD aft	0.0	0.0	0.0	0.0	0.0	0.0	0.0	145.5	3.0	1.9	1.9	0.0	Yes	
	fwd	0.0	0.0	0.0	0.0	0.0	0.0	0.0	145.5	3.0	1.9	1.9	0.0		
WELD aft	0.0	0.0	0.0	0.0	4.0	6.0	0.0	0.0	0.3	1.0	0.0	0.0	Yes		
fwd	0.0	0.0	0.0	0.0	4.0	6.0	0.0	0.0	0.3	1.0	0.0	0.0			
44	ACT aft	(31) EC31 (Da) Direct without lug asym, t=10						1.5	0.0	90.0	1.8	1.8	355.0	0.0	
	fwd	(31) EC31 (Da) Direct without lug asym, t=10						1.5	0.0	90.0	1.8	1.8	355.0	0.0	
	YIELD aft	0.0	0.0	0.0	0.0	0.0	0.0	0.0	145.5	3.0	1.9	1.9	0.0	Yes	
	fwd	0.0	0.0	0.0	0.0	0.0	0.0	0.0	145.5	3.0	1.9	1.9	0.0		
WELD aft	0.0	0.0	0.0	0.0	4.0	6.0	0.0	0.0	0.3	1.0	0.0	0.0	Yes		
fwd	0.0	0.0	0.0	0.0	4.0	6.0	0.0	0.0	0.3	1.0	0.0	0.0			
45	ACT aft	(31) EC31 (Da) Direct without lug asym, t=10						1.5	0.0	90.0	1.8	1.8	355.0	0.0	
	fwd	(31) EC31 (Da) Direct without lug asym, t=10						1.5	0.0	90.0	1.8	1.8	355.0	0.0	
	YIELD aft	0.0	0.0	0.0	0.0	0.0	0.0	0.0	145.5	3.0	1.9	1.9	0.0	Yes	
	fwd	0.0	0.0	0.0	0.0	0.0	0.0	0.0	145.5	3.0	1.9	1.9	0.0		
WELD aft	0.0	0.0	0.0	0.0	4.0	6.0	0.0	0.0	0.3	1.0	0.0	0.0	Yes		
fwd	0.0	0.0	0.0	0.0	4.0	6.0	0.0	0.0	0.3	1.0	0.0	0.0			
22	ACT aft	(31) EC31 (Da) Direct without lug asym, t=10						1.5	0.0	90.0	1.8	1.8	355.0	0.0	
	fwd	(31) EC31 (Da) Direct without lug asym, t=10						1.5	0.0	90.0	1.8	1.8	355.0	0.0	
	YIELD aft	0.0	0.0	0.0	0.0	0.0	0.0	0.0	145.5	3.0	1.9	1.9	0.0	Yes	
	fwd	0.0	0.0	0.0	0.0	0.0	0.0	0.0	145.5	3.0	1.9	1.9	0.0		
WELD aft	0.0	0.0	0.0	0.0	4.0	6.0	0.0	0.0	0.3	1.0	0.0	0.0	Yes		
fwd	0.0	0.0	0.0	0.0	4.0	6.0	0.0	0.0	0.3	1.0	0.0	0.0			
24	ACT aft	(31) EC31 (Da) Direct without lug asym, t=10						1.5	0.0	90.0	1.8	1.8	355.0	0.0	
	fwd	(31) EC31 (Da) Direct without lug asym, t=10						1.5	0.0	90.0	1.8	1.8	355.0	0.0	
	YIELD aft	0.0	0.0	0.0	0.0	0.0	0.0	0.0	145.5	3.0	1.9	1.9	0.0	Yes	
	fwd	0.0	0.0	0.0	0.0	0.0	0.0	0.0	145.5	3.0	1.9	1.9	0.0		
WELD aft	0.0	0.0	0.0	0.0	4.0	6.0	0.0	0.0	0.3	1.0	0.0	0.0	Yes		
fwd	0.0	0.0	0.0	0.0	4.0	6.0	0.0	0.0	0.3	1.0	0.0	0.0			

ID	ACT aft fwd	End conn Shear conn						t _c PSM [mm]	t _c web stiff [mm]	PSM web angle φ _w [deg]	S1 [m]	S2 [m]	R _{eH} PSM [N/mm ²]	R _{eH} web stiff [N/mm ²]	OK?
		σ _w perm [N/mm ²]		σ _w [N/mm ²]		σ _{wc} perm [N/mm ²]									
WELD aft fwd	l _{leg} web stiff [mm]	l _{leg} brkt [mm]		l _{leg} direct [mm]		l _{leg} lug [mm]		f _{weld}	f _c	l _s [mm]	d _{we} [mm]			OK?	
		req	act	req	act	req	act								req
26	ACT aft	(31) EC31 (Da) Direct without lug asym, t=10						1.5	0.0	90.0	1.8	1.8	355.0	0.0	
	fwd	(31) EC31 (Da) Direct without lug asym, t=10						1.5	0.0	90.0	1.8	1.8	355.0	0.0	
	YIELD aft fwd	0.0 0.0	0.0 0.0	0.0 0.0	0.0 0.0	0.0 0.0	0.0 0.0	0.0 0.0	145.5 145.5	3.0 3.0	1.9 1.9	1.9 1.9	0.0 0.0	Yes	
	WELD aft fwd	0.0 0.0	0.0 0.0	0.0 0.0	4.0 4.0	6.0 6.0	0.0 0.0	0.0 0.0	0.3 1.0	1.0 1.0	0.0 0.0	0.0 0.0		Yes	
27	ACT aft	(31) EC31 (Da) Direct without lug asym, t=10						1.5	0.0	90.0	1.8	1.8	355.0	0.0	
	fwd	(31) EC31 (Da) Direct without lug asym, t=10						1.5	0.0	90.0	1.8	1.8	355.0	0.0	
	YIELD aft fwd	0.0 0.0	0.0 0.0	0.0 0.0	0.0 0.0	0.0 0.0	0.0 0.0	0.0 0.0	145.5 145.5	3.0 3.0	1.9 1.9	1.9 1.9	0.0 0.0	Yes	
	WELD aft fwd	0.0 0.0	0.0 0.0	0.0 0.0	4.0 4.0	6.0 6.0	0.0 0.0	0.0 0.0	0.3 1.0	1.0 1.0	0.0 0.0	0.0 0.0		Yes	
29	ACT aft	(31) EC31 (Da) Direct without lug asym, t=10						1.5	0.0	90.0	1.8	1.8	355.0	0.0	
	fwd	(31) EC31 (Da) Direct without lug asym, t=10						1.5	0.0	90.0	1.8	1.8	355.0	0.0	
	YIELD aft fwd	0.0 0.0	0.0 0.0	0.0 0.0	0.0 0.0	0.0 0.0	0.0 0.0	0.0 0.0	145.5 145.5	3.0 3.0	1.9 1.9	1.9 1.9	0.0 0.0	Yes	
	WELD aft fwd	0.0 0.0	0.0 0.0	0.0 0.0	4.0 4.0	6.0 6.0	0.0 0.0	0.0 0.0	0.3 1.0	1.0 1.0	0.0 0.0	0.0 0.0		Yes	
30	ACT aft	(31) EC31 (Da) Direct without lug asym, t=10						1.5	0.0	90.0	1.8	1.8	355.0	0.0	
	fwd	(31) EC31 (Da) Direct without lug asym, t=10						1.5	0.0	90.0	1.8	1.8	355.0	0.0	
	YIELD aft fwd	0.0 0.0	0.0 0.0	0.0 0.0	0.0 0.0	0.0 0.0	0.0 0.0	0.0 0.0	145.5 145.5	3.0 3.0	1.9 1.9	1.9 1.9	0.0 0.0	Yes	
	WELD aft fwd	0.0 0.0	0.0 0.0	0.0 0.0	4.0 4.0	6.0 6.0	0.0 0.0	0.0 0.0	0.3 1.0	1.0 1.0	0.0 0.0	0.0 0.0		Yes	
31	ACT aft	(31) EC31 (Da) Direct without lug asym, t=10						1.5	0.0	90.0	1.8	1.8	355.0	0.0	
	fwd	(31) EC31 (Da) Direct without lug asym, t=10						1.5	0.0	90.0	1.8	1.8	355.0	0.0	
	YIELD aft fwd	0.0 0.0	0.0 0.0	0.0 0.0	0.0 0.0	0.0 0.0	0.0 0.0	0.0 0.0	145.5 145.5	2.5 2.5	1.6 1.6	1.6 1.6	0.0 0.0	Yes	
	WELD aft fwd	0.0 0.0	0.0 0.0	0.0 0.0	4.0 4.0	6.0 6.0	0.0 0.0	0.0 0.0	0.3 1.0	1.0 1.0	0.0 0.0	0.0 0.0		Yes	
54	ACT aft	(31) EC31 (Da) Direct without lug asym, t=10						1.5	0.0	90.0	1.8	1.8	355.0	0.0	
	fwd	(31) EC31 (Da) Direct without lug asym, t=10						1.5	0.0	90.0	1.8	1.8	355.0	0.0	
	YIELD aft fwd	0.0 0.0	0.0 0.0	0.0 0.0	0.0 0.0	0.0 0.0	0.0 0.0	0.0 0.0	145.5 145.5	7.5 7.5	6.1 6.1	6.1 6.1	0.0 0.0	Yes	
	WELD aft fwd	0.0 0.0	0.0 0.0	0.0 0.0	4.0 4.0	6.0 6.0	0.0 0.0	0.0 0.0	0.3 1.0	1.0 1.0	0.0 0.0	0.0 0.0		Yes	
46	ACT aft	(31) EC31 (Da) Direct without lug asym, t=10						1.5	0.0	90.0	1.8	1.8	355.0	0.0	
	fwd	(31) EC31 (Da) Direct without lug asym, t=10						1.5	0.0	90.0	1.8	1.8	355.0	0.0	
	YIELD aft fwd	0.0 0.0	0.0 0.0	0.0 0.0	0.0 0.0	0.0 0.0	0.0 0.0	0.0 0.0	145.5 145.5	7.5 7.5	6.1 6.1	6.1 6.1	0.0 0.0	Yes	
	WELD aft fwd	0.0 0.0	0.0 0.0	0.0 0.0	4.0 4.0	6.0 6.0	0.0 0.0	0.0 0.0	0.3 1.0	1.0 1.0	0.0 0.0	0.0 0.0		Yes	
58	ACT aft	(31) EC31 (Da) Direct without lug asym, t=10						0.5	0.0	90.0	1.8	1.8	355.0	0.0	
	fwd	(31) EC31 (Da) Direct without lug asym, t=10						0.5	0.0	90.0	1.8	1.8	355.0	0.0	
	YIELD aft fwd	0.0 0.0	0.0 0.0	0.0 0.0	0.0 0.0	0.0 0.0	0.0 0.0	0.0 0.0	184.5 184.5	113.5 113.5	102.4 102.4	102.4 102.4	0.0 0.0	Yes	
	WELD aft fwd	0.0 0.0	0.0 0.0	0.0 0.0	5.5 5.5	6.0 6.0	0.0 0.0	0.0 0.0	0.3 1.0	1.0 1.0	95.0 95.0	0.0 0.0		Yes	

Inner bottom at #99

ID	ACT aft fwd	End conn Shear conn						t _c PSM [mm]	t _c web stiff [mm]	PSM web angle φ _w [deg]	S1 [m]	S2 [m]	R _{eH} PSM [N/mm ²]	R _{eH} web stiff [N/mm ²]	OK?
		σ _w perm [N/mm ²]		σ _w [N/mm ²]		σ _{wc} perm [N/mm ²]									
WELD aft fwd	l _{leg} web stiff [mm]	l _{leg} brkt [mm]		l _{leg} direct [mm]		l _{leg} lug [mm]		f _{weld}	f _c	l _s [mm]	d _{we} [mm]			OK?	
		req	act	req	act	req	act								req
59	ACT aft	(31) EC31 (Da) Direct without lug asym, t=10						0.5	0.0	90.0	1.8	1.8	355.0	0.0	
	fwd	(31) EC31 (Da) Direct without lug asym, t=10						0.5	0.0	90.0	1.8	1.8	355.0	0.0	
	YIELD aft	0.0	0.0	0.0	0.0	0.0	0.0	0.0	184.5	113.5	102.4	102.4	0.0	Yes	
	fwd	0.0	0.0	0.0	0.0	0.0	0.0	0.0	184.5	113.5	102.4	102.4	0.0		
	WELD aft	0.0	0.0	0.0	0.0	5.5	6.0	0.0	0.3	1.0	95.0	0.0		Yes	
	fwd	0.0	0.0	0.0	0.0	5.5	6.0	0.0	0.3	1.0	95.0	0.0			
60	ACT aft	(31) EC31 (Da) Direct without lug asym, t=10						0.5	0.0	90.0	1.8	1.8	355.0	0.0	
	fwd	(31) EC31 (Da) Direct without lug asym, t=10						0.5	0.0	90.0	1.8	1.8	355.0	0.0	
	YIELD aft	0.0	0.0	0.0	0.0	0.0	0.0	0.0	184.5	113.5	102.4	102.4	0.0	Yes	
	fwd	0.0	0.0	0.0	0.0	0.0	0.0	0.0	184.5	113.5	102.4	102.4	0.0		
	WELD aft	0.0	0.0	0.0	0.0	5.5	6.0	0.0	0.3	1.0	95.0	0.0		Yes	
	fwd	0.0	0.0	0.0	0.0	5.5	6.0	0.0	0.3	1.0	95.0	0.0			
61	ACT aft	(31) EC31 (Da) Direct without lug asym, t=10						0.5	0.0	90.0	1.8	1.8	355.0	0.0	
	fwd	(31) EC31 (Da) Direct without lug asym, t=10						0.5	0.0	90.0	1.8	1.8	355.0	0.0	
	YIELD aft	0.0	0.0	0.0	0.0	0.0	0.0	0.0	184.5	113.5	102.4	102.4	0.0	Yes	
	fwd	0.0	0.0	0.0	0.0	0.0	0.0	0.0	184.5	113.5	102.4	102.4	0.0		
	WELD aft	0.0	0.0	0.0	0.0	5.5	6.0	0.0	0.3	1.0	95.0	0.0		Yes	
	fwd	0.0	0.0	0.0	0.0	5.5	6.0	0.0	0.3	1.0	95.0	0.0			
62	ACT aft	(31) EC31 (Da) Direct without lug asym, t=10						0.5	0.0	90.0	1.8	1.8	355.0	0.0	
	fwd	(31) EC31 (Da) Direct without lug asym, t=10						0.5	0.0	90.0	1.8	1.8	355.0	0.0	
	YIELD aft	0.0	0.0	0.0	0.0	0.0	0.0	0.0	184.5	113.5	102.4	102.4	0.0	Yes	
	fwd	0.0	0.0	0.0	0.0	0.0	0.0	0.0	184.5	113.5	102.4	102.4	0.0		
	WELD aft	0.0	0.0	0.0	0.0	5.5	6.0	0.0	0.3	1.0	95.0	0.0		Yes	
	fwd	0.0	0.0	0.0	0.0	5.5	6.0	0.0	0.3	1.0	95.0	0.0			
64	ACT aft	(31) EC31 (Da) Direct without lug asym, t=10						1.5	0.0	90.0	1.8	1.8	355.0	0.0	
	fwd	(31) EC31 (Da) Direct without lug asym, t=10						1.5	0.0	90.0	1.8	1.8	355.0	0.0	
	YIELD aft	0.0	0.0	0.0	0.0	0.0	0.0	0.0	145.5	6.2	6.1	6.1	0.0	Yes	
	fwd	0.0	0.0	0.0	0.0	0.0	0.0	0.0	145.5	6.2	6.1	6.1	0.0		
	WELD aft	0.0	0.0	0.0	0.0	4.0	6.0	0.0	0.3	1.0	0.0	0.0		Yes	
	fwd	0.0	0.0	0.0	0.0	4.0	6.0	0.0	0.3	1.0	0.0	0.0			
65	ACT aft	(31) EC31 (Da) Direct without lug asym, t=10						1.5	0.0	90.0	1.8	1.8	355.0	0.0	
	fwd	(31) EC31 (Da) Direct without lug asym, t=10						1.5	0.0	90.0	1.8	1.8	355.0	0.0	
	YIELD aft	0.0	0.0	0.0	0.0	0.0	0.0	0.0	145.5	6.2	6.1	6.1	0.0	Yes	
	fwd	0.0	0.0	0.0	0.0	0.0	0.0	0.0	145.5	6.2	6.1	6.1	0.0		
	WELD aft	0.0	0.0	0.0	0.0	4.0	6.0	0.0	0.3	1.0	0.0	0.0		Yes	
	fwd	0.0	0.0	0.0	0.0	4.0	6.0	0.0	0.3	1.0	0.0	0.0			
66	ACT aft	(31) EC31 (Da) Direct without lug asym, t=10						1.5	0.0	90.0	1.8	1.8	355.0	0.0	
	fwd	(31) EC31 (Da) Direct without lug asym, t=10						1.5	0.0	90.0	1.8	1.8	355.0	0.0	
	YIELD aft	0.0	0.0	0.0	0.0	0.0	0.0	0.0	145.5	6.2	6.1	6.1	0.0	Yes	
	fwd	0.0	0.0	0.0	0.0	0.0	0.0	0.0	145.5	6.2	6.1	6.1	0.0		
	WELD aft	0.0	0.0	0.0	0.0	4.0	6.0	0.0	0.3	1.0	0.0	0.0		Yes	
	fwd	0.0	0.0	0.0	0.0	4.0	6.0	0.0	0.3	1.0	0.0	0.0			
67	ACT aft	(31) EC31 (Da) Direct without lug asym, t=10						1.5	0.0	90.0	1.8	1.8	355.0	0.0	
	fwd	(31) EC31 (Da) Direct without lug asym, t=10						1.5	0.0	90.0	1.8	1.8	355.0	0.0	
	YIELD aft	0.0	0.0	0.0	0.0	0.0	0.0	0.0	145.5	6.2	6.1	6.1	0.0	Yes	
	fwd	0.0	0.0	0.0	0.0	0.0	0.0	0.0	145.5	6.2	6.1	6.1	0.0		
	WELD aft	0.0	0.0	0.0	0.0	4.0	6.0	0.0	0.3	1.0	0.0	0.0		Yes	
	fwd	0.0	0.0	0.0	0.0	4.0	6.0	0.0	0.3	1.0	0.0	0.0			
68	ACT aft	(31) EC31 (Da) Direct without lug asym, t=10						1.5	0.0	90.0	1.8	1.8	355.0	0.0	
	fwd	(31) EC31 (Da) Direct without lug asym, t=10						1.5	0.0	90.0	1.8	1.8	355.0	0.0	
	YIELD aft	0.0	0.0	0.0	0.0	0.0	0.0	0.0	145.5	5.6	5.5	5.5	0.0	Yes	
	fwd	0.0	0.0	0.0	0.0	0.0	0.0	0.0	145.5	5.6	5.5	5.5	0.0		
	WELD aft	0.0	0.0	0.0	0.0	4.0	6.0	0.0	0.3	1.0	0.0	0.0		Yes	
	fwd	0.0	0.0	0.0	0.0	4.0	6.0	0.0	0.3	1.0	0.0	0.0			

ID	ACT aft fwd	End conn Shear conn						t _c PSM [mm]	t _c web stiff [mm]	PSM web angle φ _w [deg]	S1 [m]	S2 [m]	R _{eH} PSM [N/mm ²]	R _{eH} web stiff [N/mm ²]	OK?
		σ _w perm [N/mm ²]		σ _w [N/mm ²]		σ _{wc} perm [N/mm ²]									
WELD aft fwd	l _{leg} web stiff [mm]	l _{leg} brkt [mm]		l _{leg} direct [mm]		l _{leg} lug [mm]		f _{weld}	f _c	l _s [mm]	d _{we} [mm]	OK?			
		req	act	req	act	req	act						req	act	
48	ACT aft	(31) EC31 (Da) Direct without lug asym, t=10						1.5	0.0	90.0	1.8	1.8	355.0	0.0	
	fwd	(31) EC31 (Da) Direct without lug asym, t=10						1.5	0.0	90.0	1.8	1.8	355.0	0.0	
	YIELD aft	0.0	0.0	0.0	0.0	0.0	0.0	0.0	145.5	7.5	6.1	6.1	0.0	Yes	
	fwd	0.0	0.0	0.0	0.0	0.0	0.0	0.0	145.5	7.5	6.1	6.1	0.0		
WELD aft	0.0	0.0	0.0	0.0	4.0	6.0	0.0	0.0	0.3	1.0	0.0	0.0	Yes		
fwd	0.0	0.0	0.0	0.0	4.0	6.0	0.0	0.0	0.3	1.0	0.0	0.0			
49	ACT aft	(31) EC31 (Da) Direct without lug asym, t=10						1.5	0.0	90.0	1.8	1.8	355.0	0.0	
	fwd	(31) EC31 (Da) Direct without lug asym, t=10						1.5	0.0	90.0	1.8	1.8	355.0	0.0	
	YIELD aft	0.0	0.0	0.0	0.0	0.0	0.0	0.0	145.5	7.5	6.1	6.1	0.0	Yes	
	fwd	0.0	0.0	0.0	0.0	0.0	0.0	0.0	145.5	7.5	6.1	6.1	0.0		
WELD aft	0.0	0.0	0.0	0.0	4.0	6.0	0.0	0.0	0.3	1.0	0.0	0.0	Yes		
fwd	0.0	0.0	0.0	0.0	4.0	6.0	0.0	0.0	0.3	1.0	0.0	0.0			
50	ACT aft	(31) EC31 (Da) Direct without lug asym, t=10						1.5	0.0	90.0	1.8	1.8	355.0	0.0	
	fwd	(31) EC31 (Da) Direct without lug asym, t=10						1.5	0.0	90.0	1.8	1.8	355.0	0.0	
	YIELD aft	0.0	0.0	0.0	0.0	0.0	0.0	0.0	145.5	7.5	6.1	6.1	0.0	Yes	
	fwd	0.0	0.0	0.0	0.0	0.0	0.0	0.0	145.5	7.5	6.1	6.1	0.0		
WELD aft	0.0	0.0	0.0	0.0	4.0	6.0	0.0	0.0	0.3	1.0	0.0	0.0	Yes		
fwd	0.0	0.0	0.0	0.0	4.0	6.0	0.0	0.0	0.3	1.0	0.0	0.0			
52	ACT aft	(31) EC31 (Da) Direct without lug asym, t=10						0.5	0.0	90.0	1.8	1.8	355.0	0.0	
	fwd	(31) EC31 (Da) Direct without lug asym, t=10						0.5	0.0	90.0	1.8	1.8	355.0	0.0	
	YIELD aft	0.0	0.0	0.0	0.0	0.0	0.0	0.0	184.5	113.5	102.4	102.4	0.0	Yes	
	fwd	0.0	0.0	0.0	0.0	0.0	0.0	0.0	184.5	113.5	102.4	102.4	0.0		
WELD aft	0.0	0.0	0.0	0.0	5.5	6.0	0.0	0.0	0.3	1.0	95.0	0.0	Yes		
fwd	0.0	0.0	0.0	0.0	5.5	6.0	0.0	0.0	0.3	1.0	95.0	0.0			
53	ACT aft	(31) EC31 (Da) Direct without lug asym, t=10						0.5	0.0	90.0	1.8	1.8	355.0	0.0	
	fwd	(31) EC31 (Da) Direct without lug asym, t=10						0.5	0.0	90.0	1.8	1.8	355.0	0.0	
	YIELD aft	0.0	0.0	0.0	0.0	0.0	0.0	0.0	184.5	113.5	102.4	102.4	0.0	Yes	
	fwd	0.0	0.0	0.0	0.0	0.0	0.0	0.0	184.5	113.5	102.4	102.4	0.0		
WELD aft	0.0	0.0	0.0	0.0	5.5	6.0	0.0	0.0	0.3	1.0	95.0	0.0	Yes		
fwd	0.0	0.0	0.0	0.0	5.5	6.0	0.0	0.0	0.3	1.0	95.0	0.0			
54	ACT aft	(31) EC31 (Da) Direct without lug asym, t=10						0.5	0.0	90.0	1.8	1.8	355.0	0.0	
	fwd	(31) EC31 (Da) Direct without lug asym, t=10						0.5	0.0	90.0	1.8	1.8	355.0	0.0	
	YIELD aft	0.0	0.0	0.0	0.0	0.0	0.0	0.0	184.5	113.5	102.4	102.4	0.0	Yes	
	fwd	0.0	0.0	0.0	0.0	0.0	0.0	0.0	184.5	113.5	102.4	102.4	0.0		
WELD aft	0.0	0.0	0.0	0.0	5.5	6.0	0.0	0.0	0.3	1.0	95.0	0.0	Yes		
fwd	0.0	0.0	0.0	0.0	5.5	6.0	0.0	0.0	0.3	1.0	95.0	0.0			
55	ACT aft	(31) EC31 (Da) Direct without lug asym, t=10						0.5	0.0	90.0	1.8	1.8	355.0	0.0	
	fwd	(31) EC31 (Da) Direct without lug asym, t=10						0.5	0.0	90.0	1.8	1.8	355.0	0.0	
	YIELD aft	0.0	0.0	0.0	0.0	0.0	0.0	0.0	184.5	113.5	102.4	102.4	0.0	Yes	
	fwd	0.0	0.0	0.0	0.0	0.0	0.0	0.0	184.5	113.5	102.4	102.4	0.0		
WELD aft	0.0	0.0	0.0	0.0	5.5	6.0	0.0	0.0	0.3	1.0	95.0	0.0	Yes		
fwd	0.0	0.0	0.0	0.0	5.5	6.0	0.0	0.0	0.3	1.0	95.0	0.0			
56	ACT aft	(31) EC31 (Da) Direct without lug asym, t=10						0.5	0.0	90.0	1.8	1.8	355.0	0.0	
	fwd	(31) EC31 (Da) Direct without lug asym, t=10						0.5	0.0	90.0	1.8	1.8	355.0	0.0	
	YIELD aft	0.0	0.0	0.0	0.0	0.0	0.0	0.0	184.5	113.5	102.4	102.4	0.0	Yes	
	fwd	0.0	0.0	0.0	0.0	0.0	0.0	0.0	184.5	113.5	102.4	102.4	0.0		
WELD aft	0.0	0.0	0.0	0.0	5.5	6.0	0.0	0.0	0.3	1.0	95.0	0.0	Yes		
fwd	0.0	0.0	0.0	0.0	5.5	6.0	0.0	0.0	0.3	1.0	95.0	0.0			

Girder6000 at #99

ID	ACT aft fwd	End conn Shear conn						t _e PSM [mm]	t _e web stiff [mm]	PSM web angle φ _w [deg]	S1 [m]	S2 [m]	R _{eH} PSM [N/mm ²]	R _{eH} web stiff [N/mm ²]	
		σ _w perm [N/mm ²]		σ _w [N/mm ²]		σ _{wc} perm [N/mm ²]									
WELD aft fwd	l _{leg} web stiff [mm]		l _{leg} brkt [mm]		l _{leg} direct [mm]		l _{leg} lug [mm]		f _{weld}	f _c	l _s [mm]	d _{we} [mm]			OK?
	req	act	req	act	req	act	req	act							
0	ACT aft	(31) EC31 (Da) Direct without lug asym, t=10						0.5	0.0	90.0	1.8	1.8	355.0	0.0	
	fwd	(3) EC3 (Da) Direct without lug asym, t=10						0.5	0.0	90.0	1.8	1.8	355.0	235.0	
	YIELD aft	0.0		0.0		0.0		0.0	145.5	17.4	9.1	9.1	0.0	Yes	
	fwd	195.1		0.0		136.3		0.0	145.5	NaN	9.1	NaN	NaN		
	WELD aft	0.0	0.0	0.0	0.0	4.0	6.0	0.0	0.0	0.3	1.0	0.0	0.0	Yes	
	fwd	3.5	6.0	0.0	0.0	4.0	6.0	0.0	0.0	0.3	1.0	0.0	0.0		
1	ACT aft	(31) EC31 (Da) Direct without lug asym, t=10						0.5	0.0	90.0	1.8	1.8	355.0	0.0	
	fwd	(3) EC3 (Da) Direct without lug asym, t=10						0.5	0.0	90.0	1.8	1.8	355.0	235.0	
	YIELD aft	0.0		0.0		0.0		0.0	145.5	16.7	8.7	8.7	0.0	Yes	
	fwd	195.1		0.0		136.3		0.0	145.5	NaN	8.7	NaN	NaN		
	WELD aft	0.0	0.0	0.0	0.0	4.0	6.0	0.0	0.0	0.3	1.0	0.0	0.0	Yes	
	fwd	3.5	6.0	0.0	0.0	4.0	6.0	0.0	0.0	0.3	1.0	0.0	0.0		

4. ZAKLJUČAK

U ovome radu dan je pregled relevantnih pravila za dimenzioniranje brodske konstrukcije izložene opterećenju od leda. Osnovna ideja ovog rada jest zadovoljavanje uvjeta lokalne i globalne čvrstoće uz maksimalnu moguću uštedu na materijalu, a cilj rada jest izrada nacrtu glavnog rebra broda. Proveden je postupak dimenzioniranja glavnog rebra istraživačkog broda koristeći softver Nauticus Hull primjenom pravila klasifikacijske kuće Det Norske Veritas (DNV). Kroz detaljnu analizu i primjenu pravila, dobivene su optimalne dimenzije glavnog rebra koje zadovoljavaju sve propisane sigurnosne i tehničke zahtjeve. Proračunom odabranog modela na kriterij uzdužne čvrstoće je ispunjen prema pravilima DNV-a i klasnoj notaciji ICE-1C. Rezultati ovog rada pokazuju da je računalni softver Nauticus Hull prikladan alat za precizno i efikasno dimenzioniranje brodskih konstrukcija koji omogućuje zadovoljavanje visokih standarda sigurnosti. Korištenjem DNV pravila osigurana je visoka pouzdanost rezultata što je ključno za projektiranje istraživačkih brodova koji često djeluju u zahtjevnim uvjetima. Projektiranje provedeno u ovom radu može poslužiti kao osnova za daljnji razvoj i unaprjeđenje metoda dimenzioniranja brodskih struktura, posebno u kontekstu integracije novih materijala i tehnologija.

LITERATURA

- [1] DNV GL: Rules for classification of ships, 2015.
- [2] DNV: Nauticus Hull User Manual, 2024.
- [3] De Naval: „DIVE/ROV Support Vessel“, s interneta, <https://www.de-naval.hr/en/projects/dive-rov>, pristupljeno 27.srpnja 2024.
- [4] Dvornik, J.: „Konstrukcija broda“, Pomorski fakultet u Splitu, Split, 2013.
- [5] Andrić, J.: „Metodologija konceptualnog projektiranja brodskih konstrukcija s interakcijom trup-nadgrađe“, Doktorski rad, Fakultet Strojarstva i brodogradnje, Zagreb, 2007.
- [6] Bucci, V., Marino, A.: „On the design of ice-strengthened superyachts“, International Conference on Marine Research and Transportation ICMRT '07, Italy, 2007.

POPIS SLIKA

Slika 1. Primjer rasporeda prostora trupa istraživačkog broda	4
Slika 2. Prikaz područja ledenog pojasa.....	8
Slika 3. Označavanje „Ice“ klase na trupu broda	9
Slika 4. Korisničko sučelje u Nauticus Hull-u	11
Slika 5. Izbornik sa svojstvima materijala.....	12
Slika 6. Glavni raspored strukture	13
Slika 7. Definirani ledeni pojas	13
Slika 8. Dijagram momenata savijanja na mirnoj vodi	16
Slika 9. Dijagram momenata savijanja na valu	16
Slika 10. Dijagram sila smicanja na mirnoj vodi	18
Slika 11. Dijagram sila smicanja na valu	19
Slika 12. Definirane pozicije geometrije presjeka.....	20
Slika 13. Prikaz geometrije presjeka okvirnog rebra	21
Slika 14. Izbornik pravila za provođenje strukturne analize	22
Slika 15. Korisničko sučelje nakon provedene analize	23
Slika 16. Prikaz usvojene strukture nakon analize	24
Slika 17. Izbornik za izradu izvještaja.....	25
Slika 18. Dijagram udjela mase konstrukcijskih elemenata.....	28

POPIS TABLICA

Tablica 1. Klase za područja plovidbe vodom infestiranom ledom prema debljini leda	7
Tablica 2. Definicija klasa za područja plovidbe vodom prekriven ledom.....	7
Tablica 3. Momenti savijanja na mirnoj vodi	15
Tablica 4. Momenti savijanja na valovima	15
Tablica 5. Sile smicanja na mirnoj vodi	18
Tablica 6. Sile smicanja na valu	18
Tablica 7. Pozicije nepropusnih pregrada po duljini.....	26
Tablica 8. Definicija materijala po poziciji na boku	27
Tablica 9. Mase elemenata strukture	28
Tablica 10. Dimenzije panela na brodu.....	29
Tablica 11. Dimenzije T nosača na boku broda	31
Tablica 12. Dimenzije T nosača na palubi ($z=4800$ mm)	32
Tablica 13. Dimenzije T nosača na palubi ($z=8100$ mm)	33
Tablica 14. Dimenzije T nosača na palubi čvrstoće	34
Tablica 15. Dimenzije uzdužnih ukrepa	35
Tablica 16. Dimenzije rebara poprečnog presjeka	36
Tablica 17. Dimenzije sponja porečnog presjeka.....	37
Tablica 18. Dimenzije rebrenica poprečnog presjeka	38
Tablica 19. Rezultati proračuna uzdužne čvrstoće	41

POPIS SIMBOLA

<i>Oznaka</i>	<i>Mjerna jedinica</i>	<i>Opis</i>
B	[m]	Projektna širina
C_B		Blok koeficijent
C_W		Koeficijent vala
D	[m]	Projektna dubina
D_{LL}	[m]	Projektna dubina nadvođa
f_m		Faktor materijala
f_{nl-vh}		Koeficijent nelinearnih efekata u progibu
f_{nl-vs}		Koeficijent nelinearnih efekata u pregibu
f_p		Faktor opterećenja
f_R		Faktor povezan s operativnim profilom
f_r		Faktor odbitka vezan uz ograničenja službe
f_{q-neg}		Distribucijski faktor po duljini broda za pozitivne smične sile
f_{q-pos}		Distribucijski faktor po duljini broda za negativne smične sile
f_{qs}		Distribucijski faktor po duljini broda =0,8
f_{sw}		Distribucijski faktor po duljini broda= 1,0
h	[m]	Projektna debljina leda
h_0	[m]	Maksimalna debljina leda
I_y	[m ⁴]	Vertikalni moment inercije
I_{y-gr}	[m ⁴]	Ukupni moment inercije oko neutralne linije
I_{yR-gr}	[m ⁴]	Moment inercije trupa brodo oko horizontalne osi
I_z	[m ⁴]	Horizontalni moment inercije
k		Koeficijent materijala
L	[m]	Duljina prema pravilima
L_{LL}	[m]	Duljina nadvođa
L_{pp}	[m]	Duljina između perpendikulara
M_{sv}	[kNm]	Dopušteni vertikalni moment savijanja na mirnoj vodi
$M_{sw-h-min}$	[kNm]	Minimalni moment savijanja na mirnoj vodi u progibu
$M_{sw-s-min}$	[kNm]	Minimalni moment savijanja na mirnoj vodi u pregibu
M_{wh}	[kNm]	Moment savijanja horizontalnog vala
M_{wv}	[kNm]	Vertikalni moment savijanja na valu
M_{wv-h}	[kNm]	Vertikalni moment savijanja na valu u progibu

M_{wv-s}	[kNm]	Vertikalni moment savijanja na valu u pregibu
$M_{wv-h-mid}$	[kNm]	Moment savijanja uslijed horizontalnog vala za procjenu čvrstoće na paralelnom srednjaku u uvjetima progiba
$M_{wv-s-mid}$	[kNm]	Moment savijanja uslijed horizontalnog vala za procjenu čvrstoće na paralelnom srednjaku u uvjetima progiba
$Q_{sw-neg-min}$	[kN]	Minimalna negativna smična sila na mirnoj vodi
$Q_{sw-pos-min}$	[kN]	Minimalna pozitivna smična sila na mirnoj vodi
Q_{wv-neg}	[kN]	Negativne sile smicanja vertikalnog vala
Q_{wv-pos}	[kN]	Pozitivne sile smicanja vertikalnog vala
T	[m]	Projektni gaz broda
V	[čv]	Maksimalna radna brzina broda
V_D	[m]	Udaljenost do palube po z-osi
x	[m]	Pozicija krmenog kraja vodne linije za duljinu nadgrađa
Z_{B-gr}	[m ³]	Moment otpora broda na dnu
Z_D	[m]	Z koordinata visine palube čvrstoće
Z_{D-gr}	[m ³]	Moment otpora broda na palubi
Z_n	[m]	Visina neutralne linije
Z_{n-gr}	[m]	Z koordinata na neutralnoj liniji poprečnog presjeka
Z_{R-gr}	[m ³]	Ukupni minimalni moment otpora presjeka paralelnog srednjaka
σ_{perm}	[N/mm ²]	Dopušteno naprezanje

SAŽETAK

U ovome radu projektirano je glavno rebro istraživačkog broda za plovidbu na područjima mora koja su prekrivena (ili sadrže led) ledom do debljine 0.4 m. Promatratne su značajke istraživačkog broda te je analiziran referentni model elemenata strukture glavnog rebra istraživačkog broda proračunatog prema pravilima DNV-a („Det Norske Veritas“). Za potrebe proračuna uzeti su osnovni podatci o brodu koji su dani na kraju završnog rada kao Prilog A. Nakon modeliranja proveden je proračun elemenata strukture trupa istraživačkog broda te je analiziran primjenom programskog alata Nauticus Hull s implementiranim pravilima DNV Rules for Classification of Ships. Na temelju rezultata proračuna dimenzionirano je glavno rebro te je izrađen nacrt poprečnog presjeka paralelnog srednjaka broda uz dodatak nepropusne pregrade. U sklopu rada objašnjen je postupak dimenzioniranja i izrade računalnog modela broda za analizu prema odrađenim proračunima i izrađenome nacrtu.

Ključne riječi: istraživački brod, Det Norske Veritas, projektiranje brodske konstrukcije, analiza strukture, granična čvrstoća, ice class, ICE-1C/E1

SUMMARY

In this paper, the main frame of a research vessel designed for navigation in the Baltic region is designed. With the observation of the characteristics of a research vessel a reference model of the of the main frame structure elements, calculated according to DNV („Det Norske Veritas“) rules, is analyzed. For calculation purposes basic data about the vessel was provided at the end of the final paper as Attachment A. After modeling, a calculation of the structural elements of the research vessel's hull was conducted and it was analyzed using the Nauticus Hull software tool in accordance with the implementation of DNV Rules for Classification of Ships. Based on the calculation results, the main frame was dimensioned, and a drawing of the main section, including a detail of a watertight bulkhead, was created. The paper explains the process of dimensioning and creating the ship's computational model for analysis based on the performed calculations and the created drawing.

Keywords: research vessel, Det Norske Veritas, ship structure design, structural analysis, ultimate strength, ice class, ICE-1C/E1

PRILOG A

OPĆI PODATCI O BRODU:

Duljina između perpendikulara, L_{PP}	[m]:	123.695
Duljina prema pravilima, L	[m]:	119.984
Duljina nadvođa, L_{LL}	[m]:	123.754
X-pozicija za krmni kraj vodene linije za duljinu nadgrađa .	[m]:	115.000
Projektna širina, B	[m]:	25.000
Projektna dubina, D	[m]:	11.300
Projektna dubina nadvođa, D_{LL}	[m]:	11.300
Konstruktivski gaz, T_{SC}	[m]:	7.200
Projektni gaz, T_{Design}	[m]:	7.200
Minimalni balastni gaz T_{BAL}	[m]:	6.750
Projektni gaz pri udarima vala na pramcu (pri praznim balastnim tankovima), T_{F-e}	[m]:	7.000
Projektni gaz pri udarima vala na pramcu (pri punim balastnim tankovima), T_{F-f}	[m]:	7.000
Blok koeficijent, C_B	:	0.650
Maksimalna radna brzina, V	[knots]:	15.000
Broj kontinuiranih paluba iznad 0.7D od osnovice	:	2
Plovilo ima više od ti kontinuirane palube?.....	:	Da
Tip nadvođa	:	A
Ugrađena bočna kobilica?.....	:	Ne
Ship with high speed and/or large flare?	:	Ne
Klasifikacijske oznake prema zahtjevu brodovlasnika:		
DNV Diving support vessel Ice(1C)		

MAIN SECTION
FRAME SPACING a=600

TYPICAL - FRAME #100

WEB FRAME #99
each 1800 mm (3rd frame)

Typ. WT-Bulkhead (Frame 112 shown)

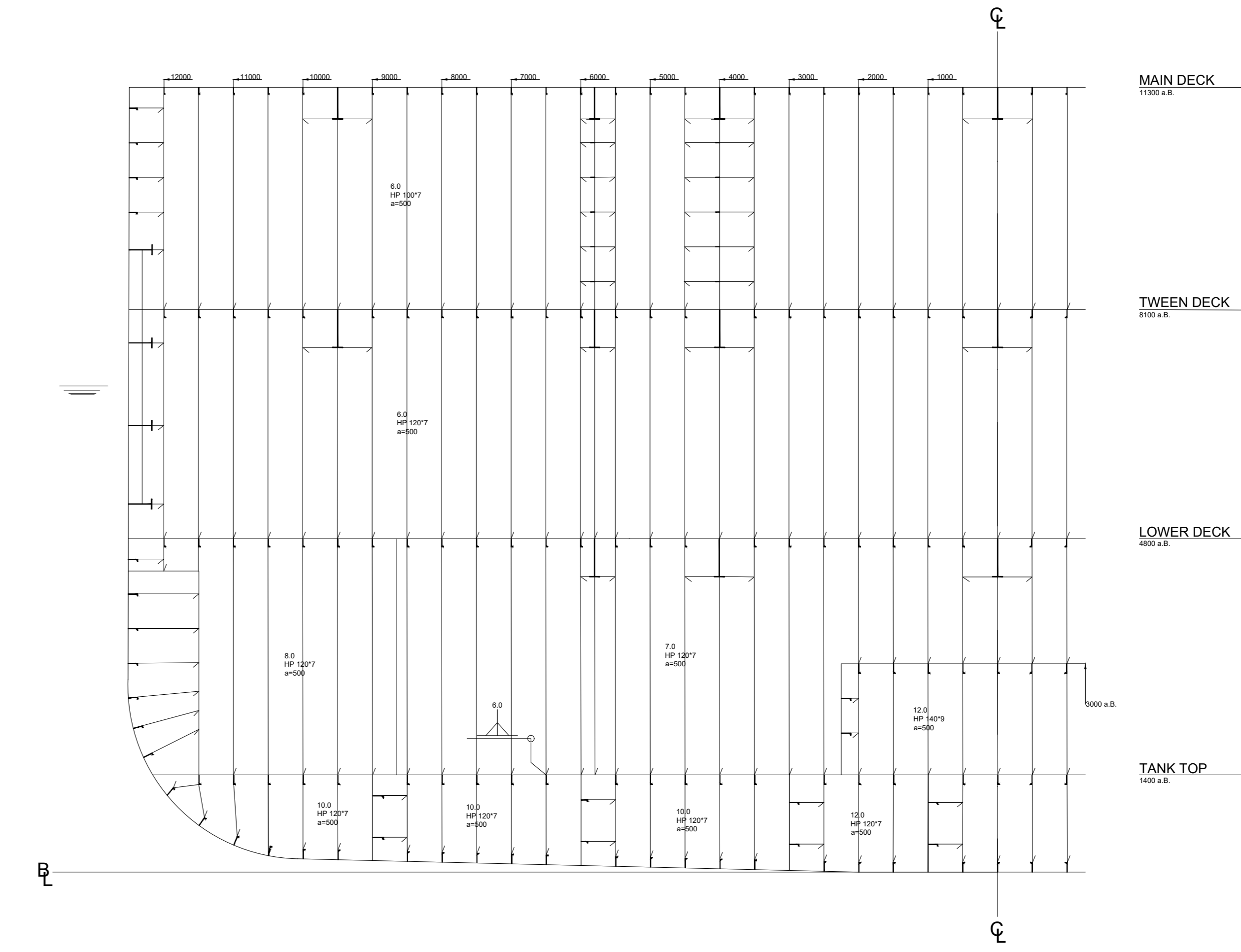
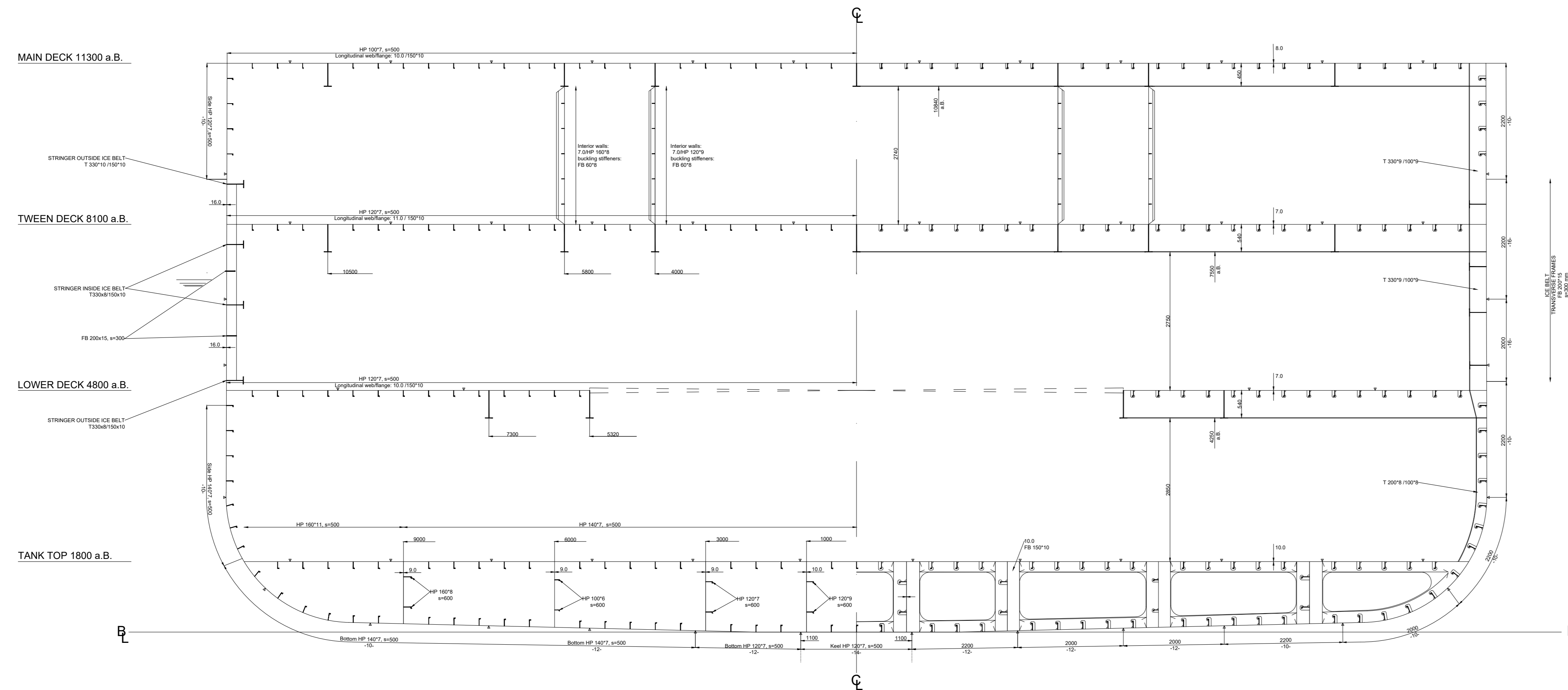

DETAIL OF ICE BELT

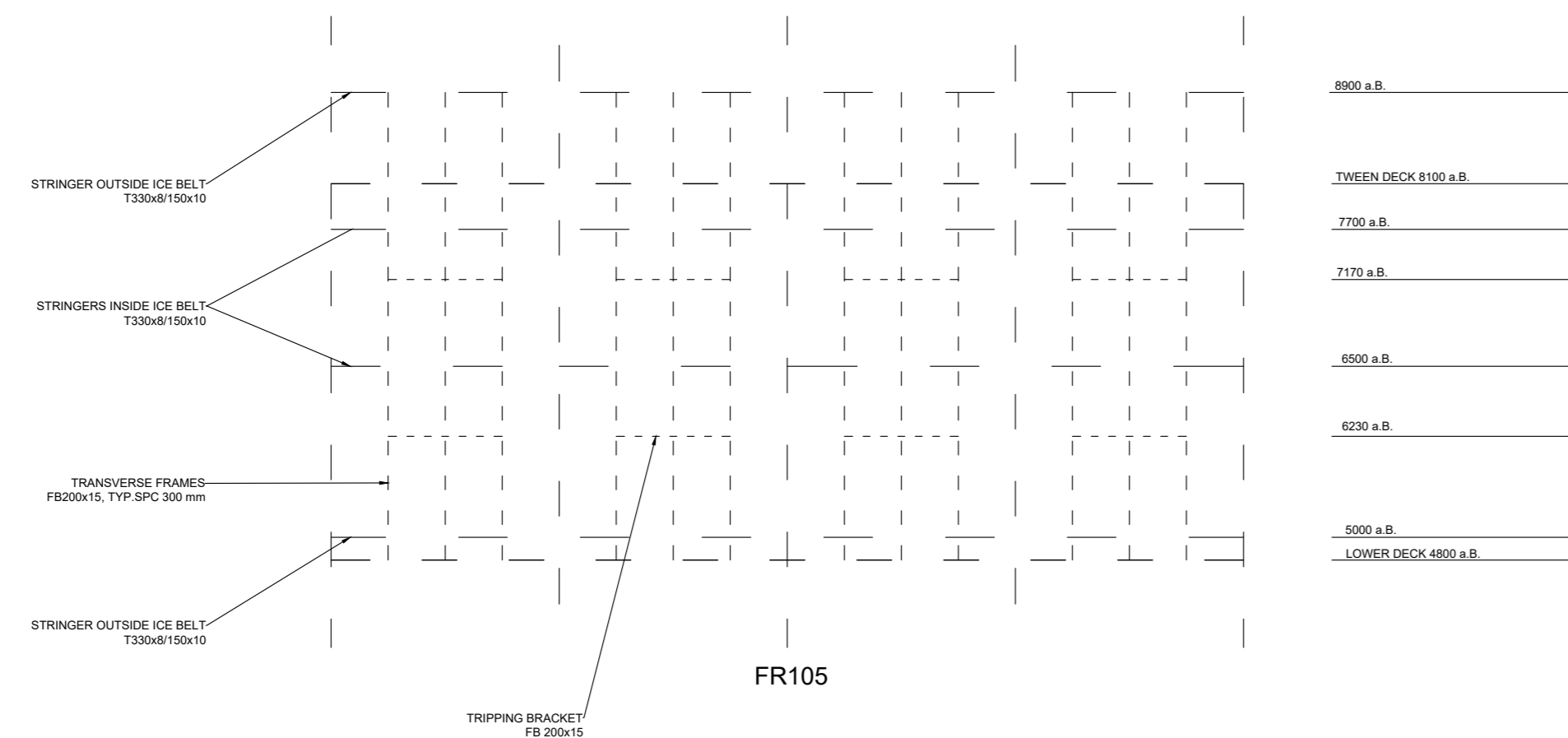

Definition of Stringer-dimensions

Stringer h^t, FB x^ty means:

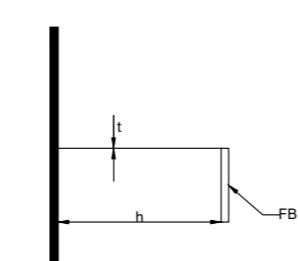

Definition of Webframe-dimensions

T H^tU^t X^tY means:

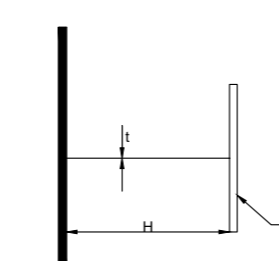

MAIN DIMENSIONS

LOA	127.000 m
LPP	117.00 m
LWL	120.00 m
RULE LENGTH	115.00 m
BREADTH MOULDED	25.00 m
DEPTH TO MAINDECK	11.30 m
DESIGN DRAUGHT	7.00 m
SCANTLING DRAUGHT	7.20 m

DISPLACEMENT (AT DESIGN DRAUGHT)	1488 t
DISPLACEMENT (AT SCANTLING DRAUGHT)	15425 t

SCANTLING SPEED	15 knots
CB	0.65

CLASS NOTATION

ICE-1C/E1

Datum	30.07.2024.	Ime i prezime	Maria Šuper	Potpis	Format: A0	Mjerilo: 1:50
Nacrtao:	30.07.2024.	Provjerio:	10.09.2024.	Albert Zamarin	List / listova: 1 / 1	Šk. god.: 2023./2024.
Odobrio:		Materijal:	VL-36		Broj crteža: 1	
Tehnički fakultet Rijeka		Naziv: Main Section				