

# Radionički nacrt stojnog dijela LM.22-DT.57

---

**Matovina, Luka**

**Supplement / Prilog**

*Publication year / Godina izdavanja:* **2022**

*Permanent link / Trajna poveznica:* <https://urn.nsk.hr/urn:nbn:hr:190:426503>

*Rights / Prava:* [Attribution 4.0 International](#)/[Imenovanje 4.0 međunarodna](#)

*Download date / Datum preuzimanja:* **2025-01-19**



*Repository / Repozitorij:*

[Repository of the University of Rijeka, Faculty of Engineering](#)



$\sqrt{\text{Ra } 6.3}$

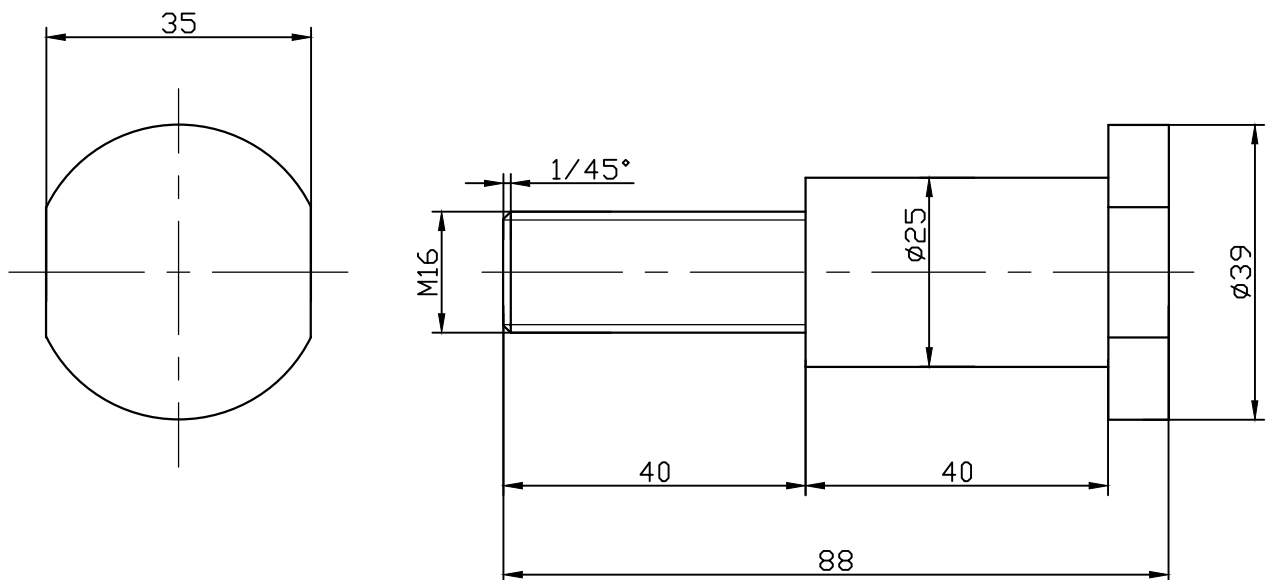

NAPOMENE:

1) Poboľjšati na  $30^{+2}$  HRC

Ime i prezime: L.Matovina		Datum: 1.6.2022	Masa (kg): 0,08	Mjerilo: 1:1
 Sveučilište u Rijeci TEHNIČKI FAKULTET 51000 RIJEKA, Vukovarska 58, HRVATSKA	Prilog 1	Materijal: 42CrMo4	Količina: 1	
	Naziv dijela: LM.22-DT57			