

Sklop CA

Donadić, Dorian

Supplement / Prilog

Publication year / Godina izdavanja: **2022**

Permanent link / Trajna poveznica: <https://urn.nsk.hr/urn:nbn:hr:190:181747>

Rights / Prava: [Attribution 4.0 International](#)/[Imenovanje 4.0 međunarodna](#)

Download date / Datum preuzimanja: **2025-02-18**



Repository / Repozitorij:

[Repository of the University of Rijeka, Faculty of Engineering](#)



CA034

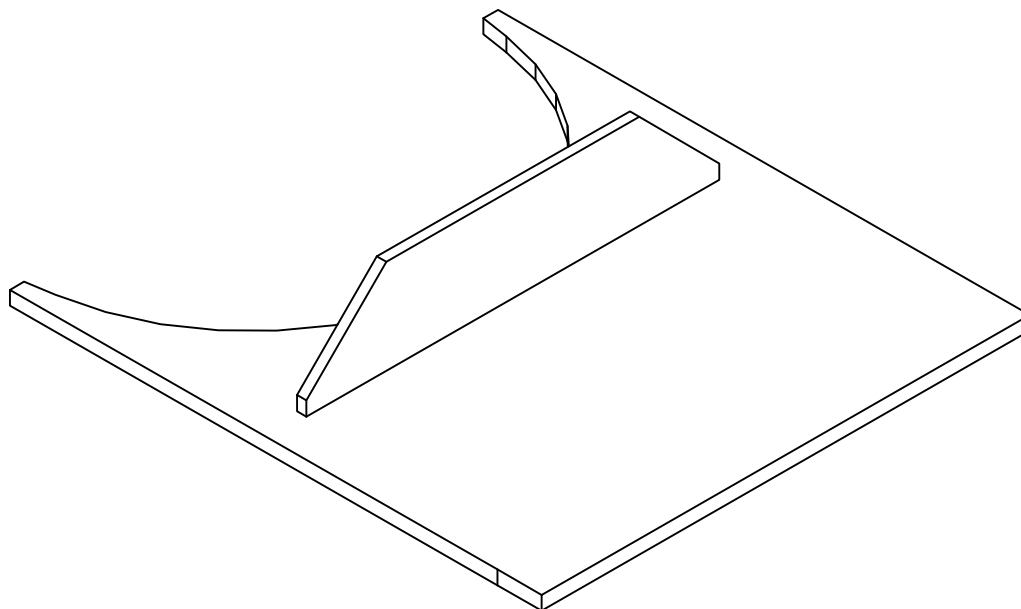

OZNAKA	RAD.MARKA	NAZIV	BROJ	DIMENZIJE	KV.MAT.	MASA [kg]
CT3410-BLP43D/S1P	637	profil	1	FB10: 100x10.0 L=438.72	A	2.9
CT3410-BLP43D-1P	142	lim	1	14.50	AH36	23.1

A4TEHNOL

SEKCIJA:	S13	S23					GRADNJA: 722,723	NACRT BROJ: 4-341-010	LIST: LISTOVA:	TEZINA: 26.009 TEZISTE X: FR109+251.
BROJ SKLOPOVA:	1	1					SKLOP: 3410-VT01-T13-S13-CA034 K1L			TEZISTE Y: 957 TEZISTE Z: 4487
							DATUM:			