

Navoz

Donadić, Dorian

Supplement / Prilog

Publication year / Godina izdavanja: **2022**

Permanent link / Trajna poveznica: <https://urn.nsk.hr/urn:nbn:hr:190:320627>

Rights / Prava: [Attribution 4.0 International](#)/[Imenovanje 4.0 međunarodna](#)

Download date / Datum preuzimanja: **2024-11-27**



Repository / Repozitorij:

[Repository of the University of Rijeka, Faculty of Engineering](#)



NAVOZ

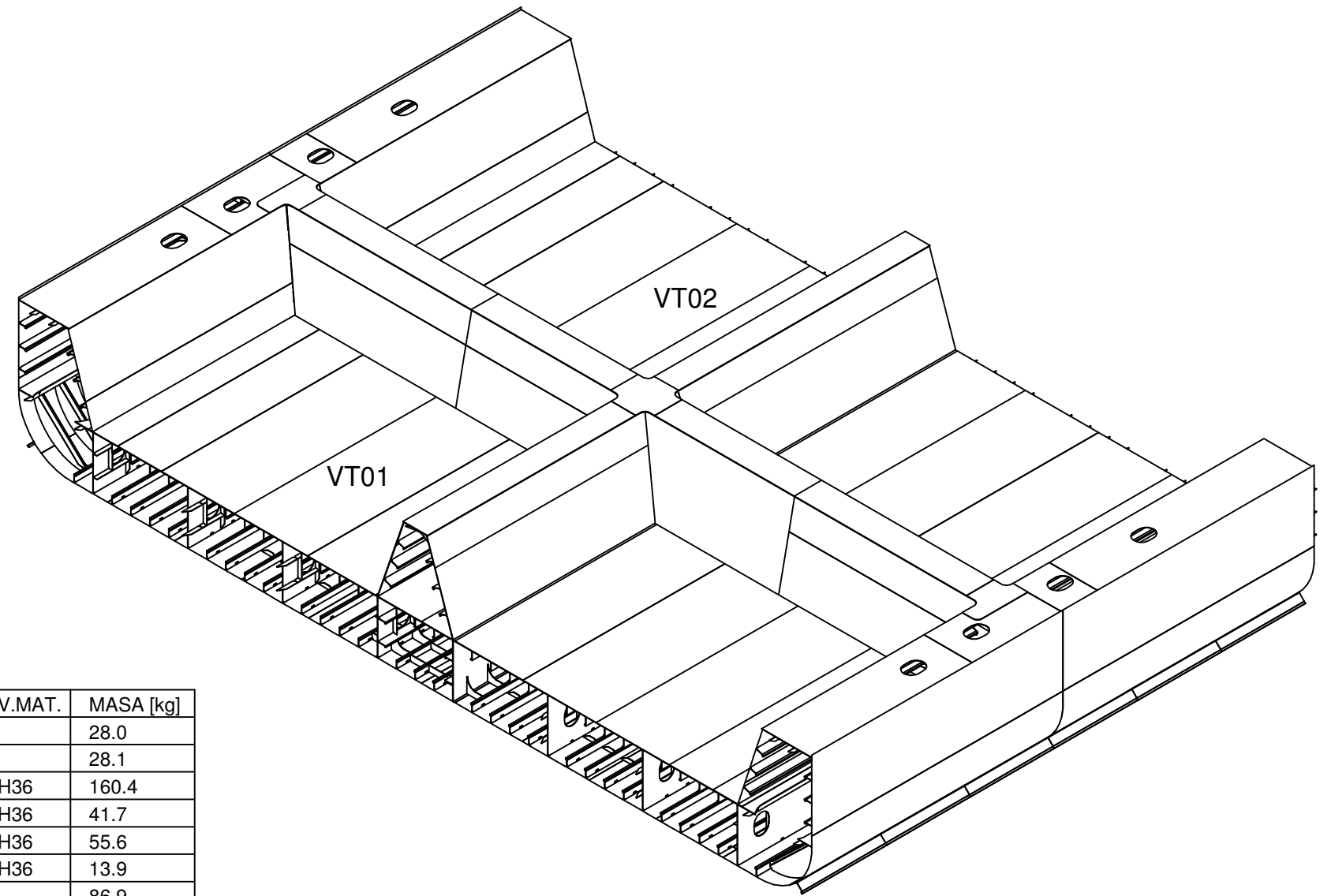

| OZNAKA | RAD.MARKA | NAZIV | BROJ | DIMENZIJE | KV.MAT. | MASA [kg] |
|--------------------|-----------|------------|------|-------------------------|---------|-----------|
| CT3410-Z5300B/S2* | 659 | profil | 4 | FB10: 150x10.0 L=696.50 | A | 28.0 |
| CT3410-Z5300B/S2* | 554 | profil | 4 | FB10: 150x10.0 L=698.00 | A | 28.1 |
| CT3410-* | 190 | lim | 122 | 13.00 | AH36 | 160.4 |
| CT3410-Y* | 553 | profil | 6 | FB10: 150x10.0 L=697.00 | AH36 | 41.7 |
| CT3410-Y* | 553 | profil | 8 | FB10: 150x10.0 L=696.00 | AH36 | 55.6 |
| CT3410-Y5390A/S37* | 552 | profil | 2 | FB10: 150x10.0 L=697.00 | AH36 | 13.9 |
| CT3410-X122* | 809 | bracket pl | 23 | 12.0 | A | 86.9 |
| CT3410-X1* | 810 | bracket pl | 21 | 12.0 | A | 74.3 |
| CT3410-* | 823 | bracket pl | 47 | 12.0 | A | 165.1 |
| CT3410-X110D-1* | 825 | bracket pl | 6 | 12.0 | A | 21.9 |
| CT3410-Z2150/S* | 551 | profil | 2 | FB10: 160x12.0 L=596.00 | A | 14.6 |
| CT3410-Z2150/S* | 550 | profil | 2 | FB10: 160x12.0 L=596.00 | A | 14.6 |
| CT3410-Z2150/S* | 551 | profil | 2 | FB10: 160x12.0 L=598.00 | A | 14.6 |
| CT3410-Z2150/S8* | 550 | profil | 2 | FB10: 160x12.0 L=598.00 | A | 14.6 |
| CT3410-YKOSO19-1SP | 68 | lim | 1 | 17.50 | AH36 | 61.1 |
| VT01 | | sklop | 1 | | | 251691.7 |
| VT02 | | sklop | 1 | | | 195768.5 |
| MP001_KALJL | | sklop | 1 | | | 87.1 |
| MP001_KALJD | | sklop | 1 | | | 87.1 |
| | POZ.1 | ČEP | 2 | 1320785 | | |
| | POZ.1 | PRSTEN | 2 | 1317679 | | |
| | POZ.1 | BRTVA | 2 | 1317733 | | |

| | | | |
|----------------------|--------------------------|------------|------------------------|
| GRADNJA: 722, 723 | NACRT BROJ: 4-341-010 | LIST: 1 | TEZINA: 448429.796 |
| | | LISTOVA: 1 | TEZISTE X: FR110+335.0 |
| SKLOP: 3410 | | | TEZISTE Y: -1 |
| DATUM: | | | TEZISTE Z: 1927 |