

VT02 dvodna

Donadić, Dorian

Supplement / Prilog

Publication year / Godina izdavanja: **2022**

Permanent link / Trajna poveznica: <https://urn.nsk.hr/urn:nbn:hr:190:689612>

Rights / Prava: [Attribution 4.0 International](#)/[Imenovanje 4.0 međunarodna](#)

Download date / Datum preuzimanja: **2024-07-17**



Repository / Repozitorij:

[Repository of the University of Rijeka, Faculty of Engineering](#)



VT02

OZNAKA	RAD.MARKA	NAZIV	BROJ	DIMENZIJE	KV.MAT.	MASA [kg]
CT3410-PVOB/S*	514	profile	8	FB10: 150x15.0 L=0.00	AH36	64.9
CT3410-PVOB/S97*	514	profile	2	FB10: 150x15.0 L=0.00	AH36	16.7
CT3410-PVOB/S71*	511	profile	2	FB10: 80x15.0 L=50.00	AH36	194.6
CT3410-PVOB/S69*	513	profile	2	HP20: 370x15.0 L=50.00	AH36	1250.5
CT3410-Z0A-2*	217	lim	2	15.00	A	24.9
CT3410-Z0A-1*	215	lim	2	15.00	A	24.9
CT3410-X122I-1*	279	lim	2	13.00	AH36	20.9
CT3410-X1*	805	bracket pl	81	12.0	A	328.9
CT3410-X1*	808	bracket pl	12	15.5	AH36	0.0
CT3410-X1*	806	bracket pl	24	13.0	AH36	0.0
CT3410-X1*	286	lim	18	15.00	AH36	367.5
CT3410-X1*	285	lim	18	15.00	AH36	642.2
CT3410-X1*	284	lim	18	15.00	AH36	443.2
CT3410-X118N-1*	265	lim	2	13.00	AH36	20.9
CT3410-X11*	809	bracket pl	30	12.0	A	113.4
CT3410-X11*	810	bracket pl	24	12.0	A	84.9
CT3410-X114I-1*	228	lim	2	13.00	AH36	20.9
P121		sklop	1			21756.0
P221		sklop	1			16658.3
KP12		sklop	1			55875.2
KP22		sklop	1			41729.7
T02		sklop	1			15687.2
T12		sklop	1			14434.1
T22		sklop	1			14434.1
MP009_UZVD		sklop	1			5787.2
MP009_UZVL		sklop	1			5787.2
	10A12	pločica	9			
	10B12	pločica	9			
	10A13	pločica	12			
	10B13	pločica	12			
	10A13 AH36	pločica	12		AH36	
	10B13 AH36	pločica	12		AH36	
	10A15.5 AH36	pločica	12		AH36	
	10B15.5 AH36	pločica	12		AH36	

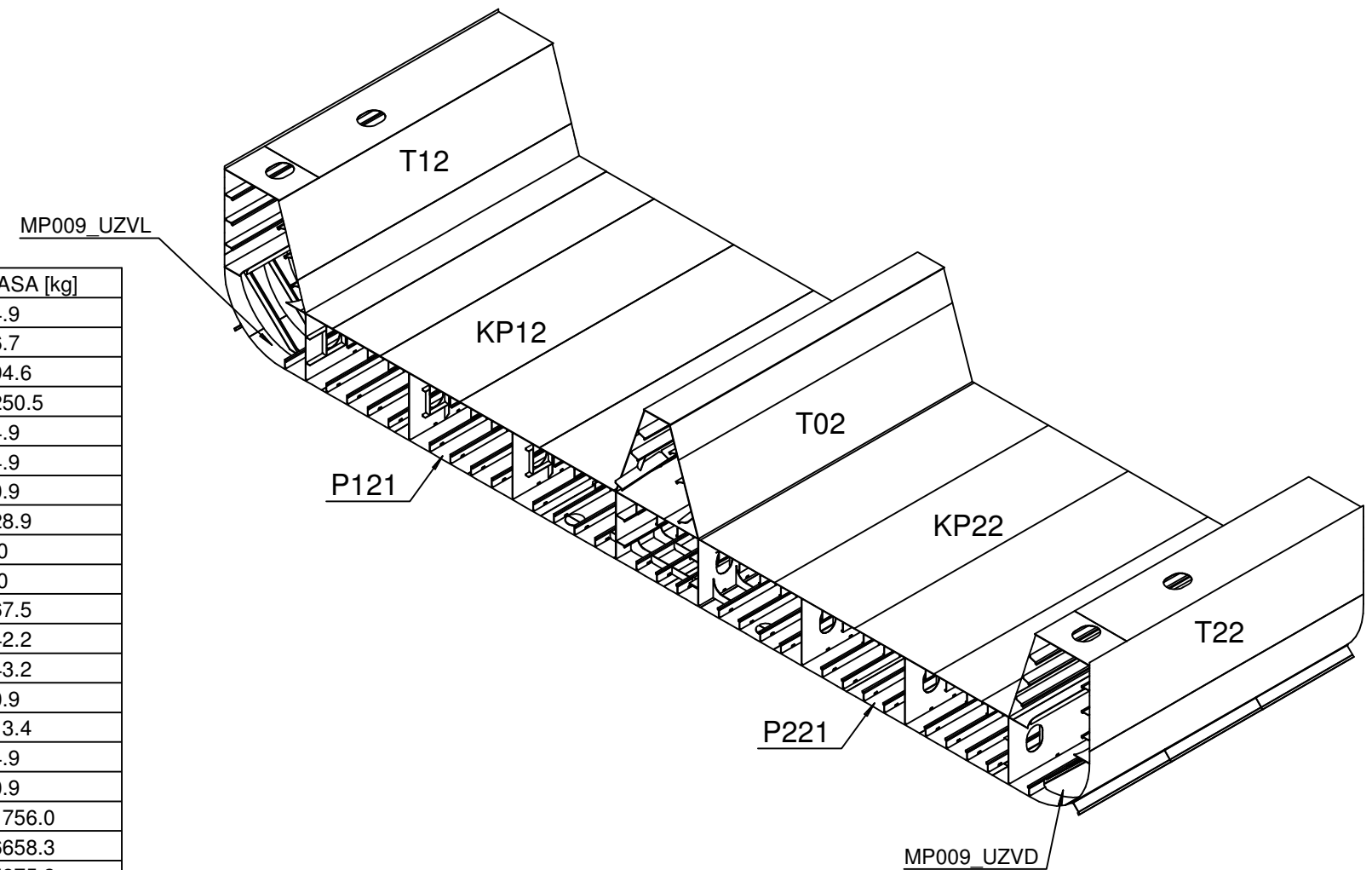

GRADNJA: 722, 723	NACRT BROJ: 4-341-010	LIST: 2	TEZINA: 195768.494
SKLOP: 3410-VT02		LISTOVA: 2	TEZISTE X: FR117-337.0
DATUM:			TEZISTE Y: 0
			TEZISTE Z: 1738