

# Kinematička i dinamička analiza Wattovog 6segmentnog mehanizma

---

Kukić, Karlo

Undergraduate thesis / Završni rad

2022

Degree Grantor / Ustanova koja je dodijelila akademski / stručni stupanj: **University of Rijeka, Faculty of Engineering / Sveučilište u Rijeci, Tehnički fakultet**

Permanent link / Trajna poveznica: <https://um.nsk.hr/um:nbn:hr:190:185353>

Rights / Prava: [Attribution 4.0 International](#)/[Imenovanje 4.0 međunarodna](#)

Download date / Datum preuzimanja: **2024-12-02**



Repository / Repozitorij:

[Repository of the University of Rijeka, Faculty of Engineering](#)



SVEUČILIŠTE U RIJECI

**TEHNIČKI FAKULTET**

Preddiplomski sveučilišni studij strojarstva

Završni rad

**KINEMATIČKA I DINAMIČKA ANALIZA WATT**

**6SEGMENTNOG MEHANIZMA**

Rijeka, rujan 2022.

Karlo Kukić

0069076628

SVEUČILIŠTE U RIJECI  
TEHNIČKI FAKULTET  
Preddiplomski sveučilišni studij strojarstva

Završni rad  
**KINEMATIČKA I DINAMIČKA ANALIZA WATT  
6SEGMENTNOG MEHANIZMA**

Mentor: prof. dr. sc. Roberto Žigulić

Rijeka, rujan 2022.

Karlo Kukić  
0069076628

Rijeka, 12. ožujka 2021.

Zavod: **Zavod za tehničku mehaniku**  
Predmet: **Dinamika**  
Grana: **2.15.06 tehnička mehanika (mekanika krutih i deformabilnih tijela)**

## ZADATAK ZA ZAVRŠNI RAD

Pristupnik: **Karlo Kukić (0069076628)**  
Studij: **Preddiplomski sveučilišni studij strojarstva**

Zadatak: **Kinematička i dinamička analiza Wattovog 6segmentnog mehanizma/  
Kinematic and dynamic analysis of Watt 6bar mechanism**

### Opis zadatka:

Proučiti dostupnu literaturu u kojoj se opisuje kinematička i dinamička analiza kako jednostavnijih tipova mehanizama (klipni mehanizmi, zglobni četverokuti, mehanizmi s koincidentnom točkom...) tako i složenijih tipova mehanizama tj. mehanizama s više članova. Proučiti i ispitati moguće primjene ravninskih mehanizama s više članova (Stephensovi i Wattovi mehanizmi), te njihove prednosti i nedostatke. Definirati kinematičke zakonitosti i jednadžbe Wattove porodice mehanizama te odrediti pomake, brzine, i ubrzanja kao i odgovarajuće kutne veličine njihovih članova. Iznijeti teorijske postavke dinamičke analize s izrazima za određivanje nepoznatih sila u zglobovima i osloncima te testirati izrađeno programsko rješenje temeljeno na Excel/VBA platformi na više primjera, varirajući pritom dimenzije pojedinih članova mehanizama i njegova opterećenja.

Rad mora biti napisan prema Uputama za pisanje diplomskih / završnih radova koje su objavljene na mrežnim stranicama studija.

  
Zadatak uručen pristupniku: 15. ožujka 2021.

Mentor:

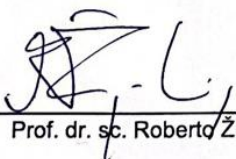
  
Prof. dr. sc. Roberto Žigulić

Predsjednik povjerenstva za  
završni ispit:

  
Prof. dr. sc. Kristian Lenić

# IZJAVA

Sukladno članku 8. pravilnika o završnom radu i završnom ispitu na preddiplomskom sveučilišnom studiju i stručnom studiju Tehničkog fakulteta Sveučilišta u Rijeci, izjavljujem da sam samostalno izradio ovaj završni rad na temu „Kinematička i dinamička analiza Wattova 6segmentnog mehanizma“, koristeći navedenu literaturu i znanje stečeno na Tehničkom fakultetu u Rijeci, pod vodstvom mentora prof. dr. sc. Roberta Žigulića.

Rijeka, sranj 2021

---

Karlo Kukić  
0069076628

## ZAHVALA

Zahvaljujem se mentoru, prof. dr. sc. Robertu Žiguliću, na odvojenom vremenu i pomoći tijekom pisanja ovog završnog rada. Također se zahvaljujem za pomoć pri odabiru teme ovog završnog rada te pojašnjavanju problema proizašlih prilikom rješavanja zadatka.

# SADRŽAJ

1. UVOD .....	1
2. KINEMATIČKA ANALIZA .....	3
2.1. Ulazni podaci.....	5
2.2. Analiza položaja.....	6
2.3. Analiza kutnih brzina .....	11
2.4. Analiza kutnih ubrzanja .....	12
3. DINAMIČKA ANALIZA.....	14
3.1. Težišta elemenata mehanizma.....	14
3.2. Ubrzanja težišta .....	16
3.3. Inercijske sile.....	17
3.4. Maseni momenti tromosti.....	18
3.5. Analiza sila.....	19
4. MODELIRANJE WATTOVIG I. TIPA MEHANIZMA U MICROSOFT EXCEL-U ..	23
4.1. Analiza položaja.....	23
4.2. Analiza kutnih brzina .....	32
4.3. Analiza kutnih ubrzanja .....	33
4.4. Analiza sila.....	34
5. PRIKAZ GIBANJA WATT I. MEHANIZMA U EXCELLU .....	38
5.1 Oslonci i segmenti mehanizma .....	38
5.2 Prikaz gibanja mehanizma (otvoreno-otvorena konfiguracija).....	39
5.3 Prikaz gibanja mehanizma (otvoreno-zatvorena konfiguracija) .....	41
5.4 Prikaz gibanja mehanizma (zatvoreno-otvorena konfiguracija) .....	43
5.5 Prikaz gibanja mehanizma (zatvoreno-zatvorena konfiguracija).....	45
6. ZAKLJUČAK .....	47
LITERATURA.....	48
POPIS SLIKA .....	49

POPIS OZNAKA .....	51
SAŽETAK.....	52
SUMMARY .....	53



## 1. UVOD

Mehanizam je uređaj koji prenosi ulazne sile i gibanja u određene izlazne sile i gibanja. Sastoje se od pokretnih dijelova koji uključuju remene, zupčanike, zglobne spojeve, bregasta vratila i slično. Glavna karakteristika mehanizama nekog stroja je da svi članovi imaju ograničeno gibanja koja mogu izvoditi samo na određeni način jedan u odnosu na drugoga.

Funkcija mehanizama sastavljenih od više članova je pretvaranje rotacijskog gibanja pogonskog segmenta u kompleksna ili jednostavna ravninska gibanja točaka, poluga ili ploča. Primjer korištenja takvog oblika mehanizma je Klannov mehanizam koji se koristi kao noge nekih hodajućih strojeva.

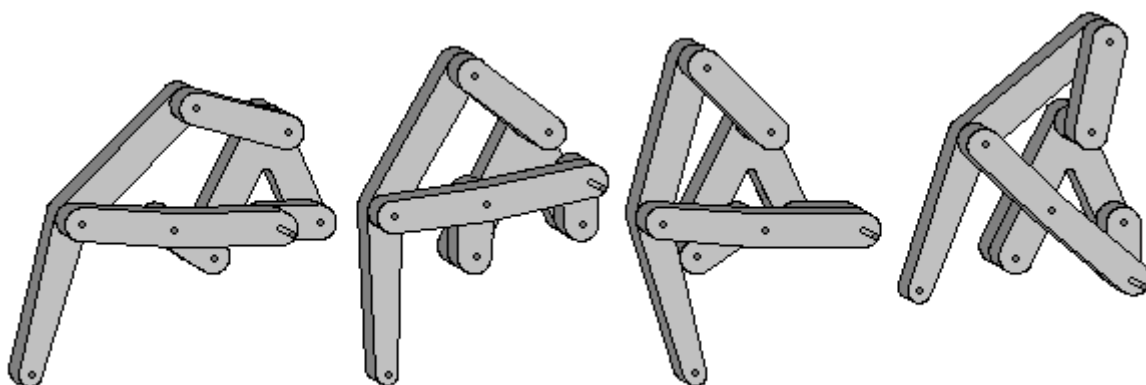

*Slika 1.1. Klannov hodajući mehanizam*

Wattov mehanizam je vrsta mehanizma koji se sastoji od centralne točke mehanizma koja se prilikom gibanja pomiče po skoro ravnoj liniji. Izmislio ga je James Watt, škotski izumitelj, inženjer i kemičar. Watt je opisao Wattov mehanizam prilikom patentiranja Wattovog parnog motora 1784. godine. Postoje dvije vrste Wattovog mehanizma: Watt I. i Watt II. Oba wattova mehanizam sastoji se od 7 zglobova i 6 poluga. Razlikuju se u tome šta Watt I. mehanizam ima četiri dvozglobe poluge i dvije trozglobne ploče dok Watt II. mehanizam ima pet dvozglobnih poluga i jednu trozglobnu ploču.

Za razliku od Stephensonovog 6-segmentnog mehanizma u kojem su ploče razdvojene dvozglobnim polugama, u Wattovom mehanizmu trozglobne ploče su međusobno spojene, a dvozglobne poluge su spojene u parove. Wattovi mehanizmi se izvode u 2 konfiguracije, Stephensonovi mehanizmi u tri konfiguracije (slike 1.2, 1.3 i 1.4).

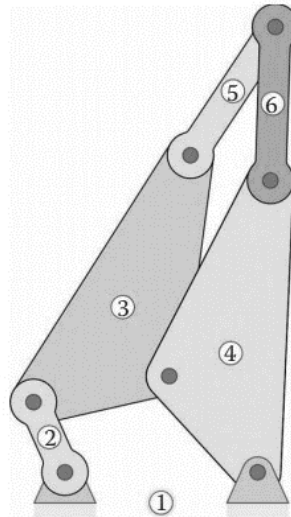
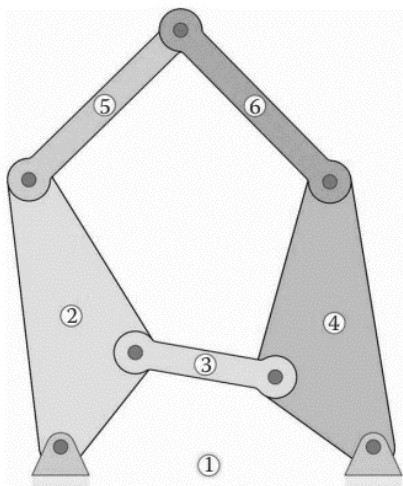

*Slika 1.2. Stephensonov I. tip i Wattov I. tip mehanizma*

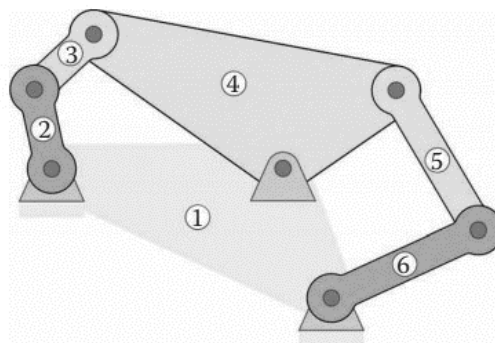
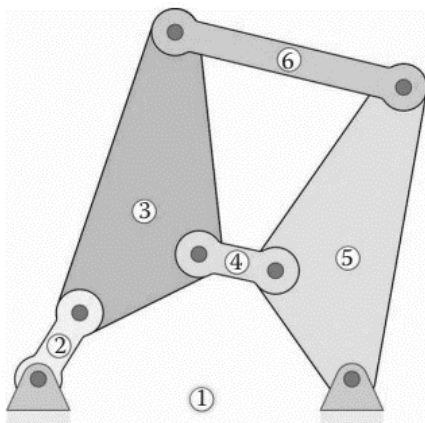

*Slika 1.3. Stephensonov II. tip i Wattov II. tip mehanizma*

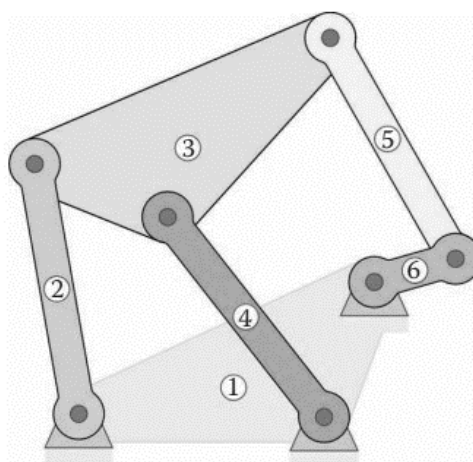

*Slika 1.4. Stephensonov III. tip mehanizma*

## 2. KINEMATIČKA ANALIZA

Kinematička analiza se koristi za definiranje vremenskog intervala u kojem se događaju promjene položaja, brzine i ubrzanja točaka, ne uzimajući u obzir sila koje djeluju na pojedine elemente. Kinematička analiza se može izvršiti grafičkim putem koji se može koristiti za izračunavanje jednostavnijih mehanizama ili analitičkim putem kojim se uz pomoć računala mogu dobiti rezultati za puno kompleksnije i zahtjevnije mehanizme.

Kinematička analiza Wattovog mehanizma prikazanog na slici 2.1 provoditi će se preko analitičke Ravenove metode kojom se primjer rješava postavljanjem vektorskih jednadžbi koje se raspisuju u oblik kompleksnih brojeva koji se onda pretvaraju u trigonometrijski oblik.

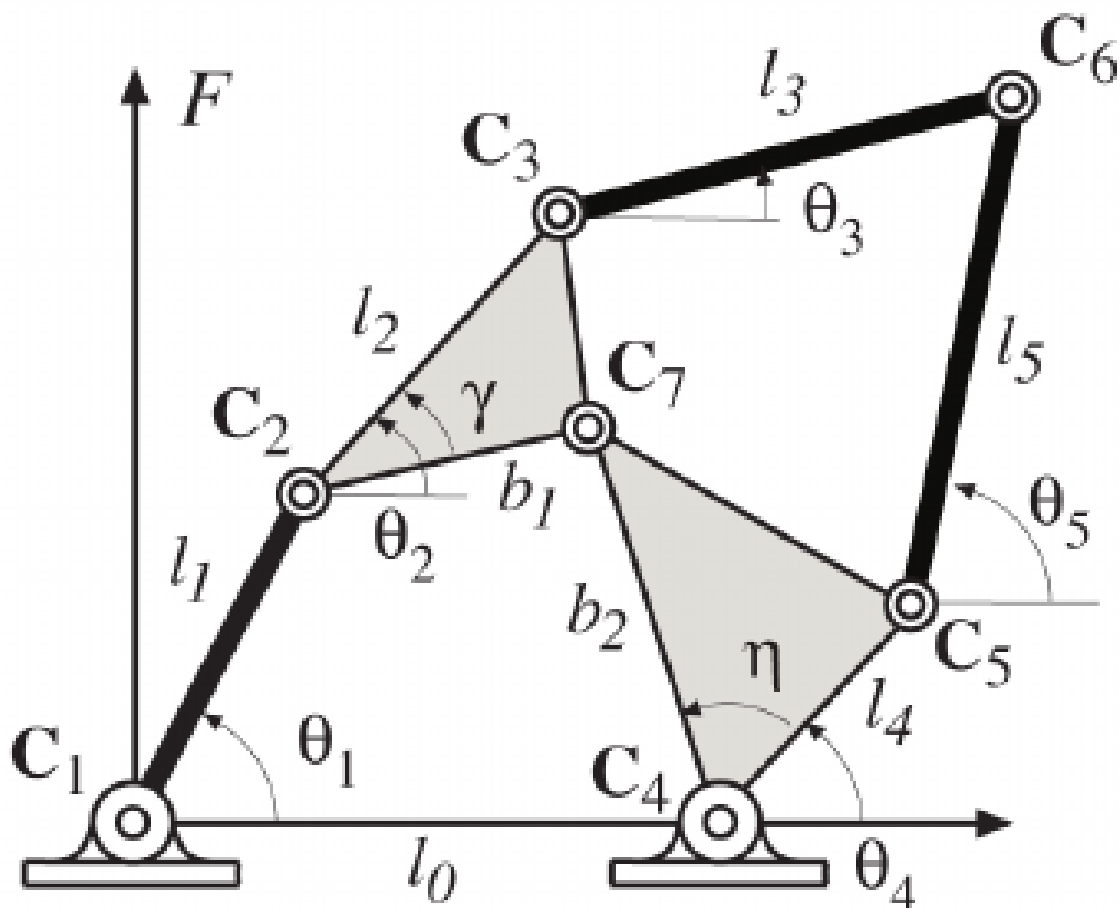

Slika 2.1. Wattov I. mehanizma – primjer

6-segmentni mehanizmi su složeni oblici mehanizama koji se promatraju kao dva odvojena 4-segmentna mehanizma, te postoje u više varijanti s istim vrijednostima duljina elemenata (otvorena i zatvorena konfiguracija).

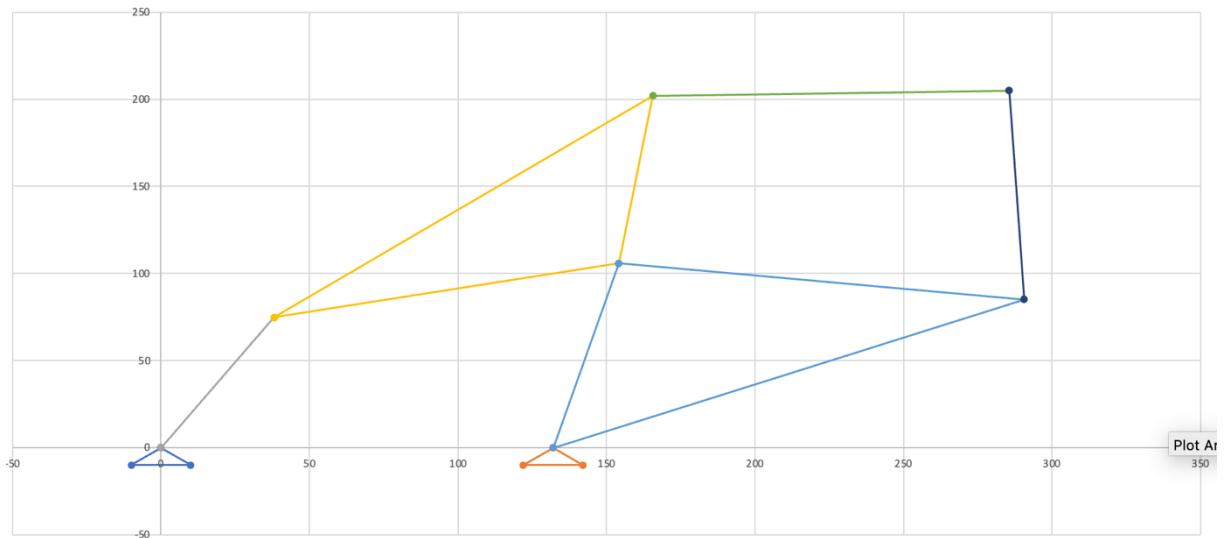

*Slika 2.2. Otvoreno-otvorena konfiguracija Wattovog I. mehanizma*

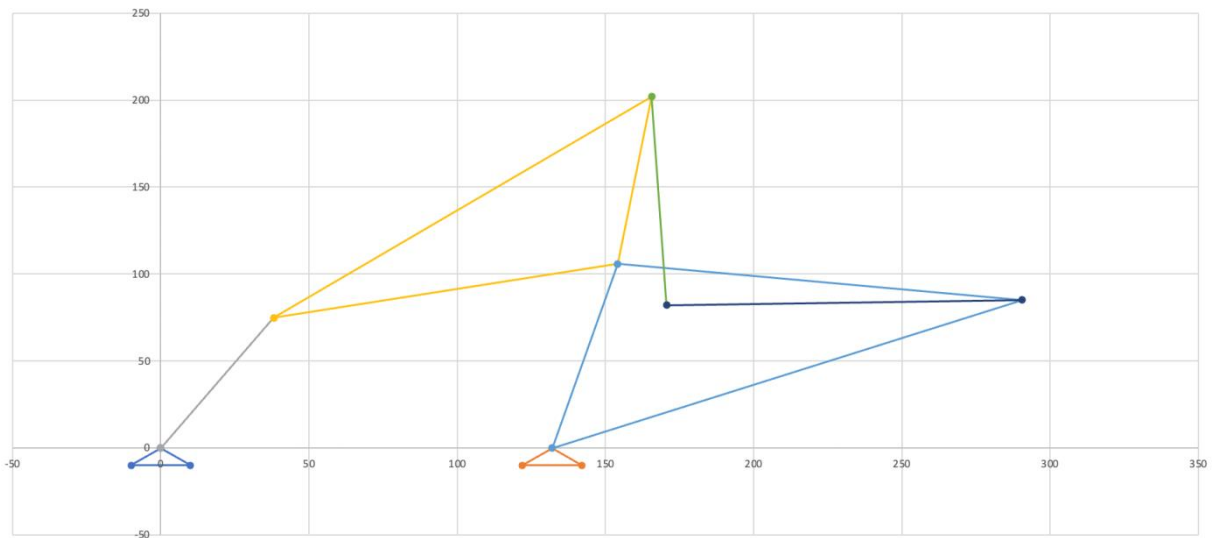

*Slika 2.3. Otvoreno-zatvorena konfiguracija Wattovog I. mehanizma*

## 2.1. Ulazni podaci

Za provođenje kinematičke analize Wattovog mehanizma i postavljanjem vektorske jednadžbe potrebni su ulazni podaci prikazani na slici 2.1., za duljine segmenata ( $r_1$ ,  $r_2$ ,  $r_3$ ,  $r_4$ ,  $r_{BE}$ ,  $r_{DF}$ ,  $r_5$  i  $r_6$ ) i kutove ( $\gamma_3$  i  $\gamma_4$ ), te kutna brzina i kutno ubrzanje pogonskog člana ( $\omega_2$ ,  $\varepsilon_2$ ). Za početak se određuje početni položaj mehanizma s kutom  $\theta_2 = 0^\circ$  prikazanog na slici 2.5.

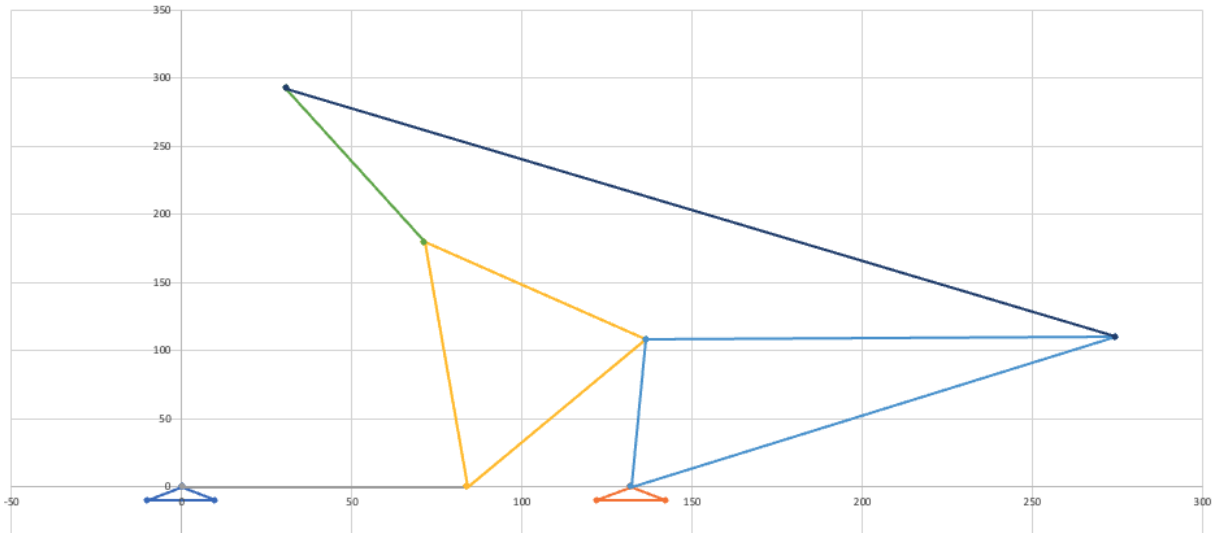

*Slika 2.4. Početni položaj mehanizma*

Mehanizam se pokreće okretanjem pogonskog člana oko točke A koja je smještena na ishodištu koordinatnog sustava. Početna kutna brzina pogonske ploče je  $\omega_2 = 1$ , a kutno ubrzanje je  $\varepsilon_2 = 1$ . Korištenjem Ravenove metode može se iz ulaznih podataka dobiti vrijednosti položaja, brzine i ubrzanja bilo koje točke mehanizma postavljanjem dvije jednostavne vektorske jednadžbe.

## 2.2. Analiza položaja

Za postavljanje vektorskih jednadžbi položaja pojedinih točaka 4-segmentnog mehanizma (točke A, B, C i D) koristi se zatvoreni poligon vektora prikazan na slici 2.6.

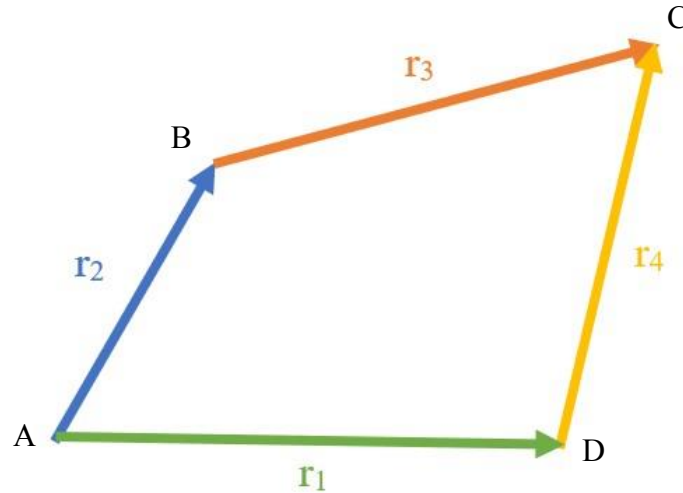

*Slika 2.5. Vektorski prikaz donjeg 4-segmentnog mehanizma*

Iz slike 2.6. slijedi slijedeća vektorska jednadžba:

$$\vec{r}_1 + \vec{r}_4 = \vec{r}_2 + \vec{r}_3 \quad (2.1)$$

$$r_1 * e^{i\theta_1} + r_4 * e^{i\theta_4} = r_2 * e^{i\theta_2} + r_3 * e^{i\theta_3}$$

Raspisivanjem vektorske jednadžbe (2.1) Ravenovom metodom dobivaju se trigonometrijske jednadžbe (2.2) i (2.3).

$$r_1 * \cos \theta_1 + r_4 * \cos \theta_4 = r_2 * \cos \theta_2 + r_3 * \cos \theta_3 \quad (2.2)$$

$$r_1 * \sin \theta_1 + r_4 * \sin \theta_4 = r_2 * \sin \theta_2 + r_3 * \sin \theta_3 \quad (2.3)$$

Vektor  $r_1$  spaja točke A i D koje su nepomični zglobovi na istoj horizontali što znači da je kut  $\theta_1 = 0$ .

$$r_4 * \cos \theta_4 = r_2 * \cos \theta_2 + r_3 * \cos \theta_3 - r_1 \quad (2.4)$$

$$r_4 * \sin \theta_4 = r_2 * \sin \theta_2 + r_3 * \sin \theta_3 \quad (2.5)$$

Kvadriranjem i zbrajanjem jednadžbi (2.4) i (2.5) dobiva se (2.10):

$$r_4 * \cos \theta_4 = r_2 * \cos \theta_2 + r_3 * \cos \theta_3 - r_1 \quad (2.6)$$

$$r_4 * \sin \theta_4 = r_2 * \sin \theta_2 + r_3 * \sin \theta_3 \quad (2.7)$$

$$r_4^2 * \cos^2 \theta_4 = r_2^2 * \cos^2 \theta_2 + 2 * r_2 * r_3 * \cos \theta_2 * \cos \theta_3 + r_3^2 * \cos^2 \theta_3 - 2 * r_1 * r_2 * \cos \theta_2 - 2 * r_1 * r_3 * \cos \theta_3 \quad (2.8)$$

$$r_4^2 * \sin^2 \theta_4 = r_2^2 * \sin^2 \theta_2 + 2 * r_2 * r_3 * \sin \theta_2 * \sin \theta_3 + r_3^2 * \sin^2 \theta_3 \quad (2.9)$$

$$\frac{r_1^2 + r_2^2 + r_3^2 - r_4^2}{2 * r_2 * r_3} + \cos \theta_2 * \cos \theta_3 + \sin \theta_2 * \sin \theta_3 - \frac{r_1}{r_3} * \cos \theta_2 - \frac{r_1}{r_2} * \cos \theta_3 = 0 \quad (2.10)$$

Uvođenjem konstanti  $k_1$ ,  $k_2$  i  $k_3$  i njihovim ubacivanjem ubacujemo u jednadžbu (2.10), dobiva se:

$$k_1 = \frac{r_1^2 + r_2^2 + r_3^2 - r_4^2}{2 * r_2 * r_3} \quad (2.11)$$

$$k_2 = \frac{r_1}{r_3} \quad (2.12)$$

$$k_3 = \frac{r_1}{r_2} \quad (2.13)$$

$$k_1 + \cos \theta_2 * \cos \theta_3 + \sin \theta_2 * \sin \theta_3 - k_2 * \cos \theta_2 - k_3 * \cos \theta_3 = 0 \quad (2.14)$$

Slijedi univerzalna zamjena sinusa i kosinusa za kut  $\theta_3$  (2.15), (2.16):

$$k_1 + \cos \theta_2 * \frac{1 - t^2}{1 + t^2} + \sin \theta_2 * \frac{2t}{1 + t^2} - k_2 * \cos \theta_2 - k_3 * \frac{1 - t^2}{1 + t^2} = 0 \quad (2.15)$$

$$k_1 * (1 + t^2) + \cos \theta_2 * (1 - t^2) + \sin \theta_2 * 2t - k_2 * \cos \theta_2 * (1 + t^2) - k_3 * (1 - t^2) = 0 \quad (2.16)$$

Koeficijentima uz  $t^2$  pridružuje se A, uz t koeficijent pridružuje se B, a ostalima C (2.17), (2.18), (2.19):

$$A = k_1 - \cos \theta_2 - k_2 * \cos \theta_2 + k_3 \quad (2.17)$$

$$B = 2 * \sin \theta_2 \quad (2.18)$$

$$C = k_1 + \cos \theta_2 - k_2 * \cos \theta_2 - k_3 \quad (2.19)$$

Dobivamo kut  $\theta_3$  s 2 moguća rješenja (2.20):

$$\theta_3 = 2 * \text{atan}\left(\frac{-B \pm \sqrt{B^2 - 4 * A * C}}{2 * A}\right) \quad (2.20)$$

Istim postupkom dobiva se formulu za kut  $\theta_4$ :

$$r_3 = r_1 + r_4 - r_2 \quad (2.21)$$

$$r_3 * \cos \theta_3 = r_1 + r_4 * \cos \theta_4 - r_2 * \cos \theta_2 \quad (2.22)$$

$$r_3 * \cos \theta_3 = r_4 * \cos \theta_4 - r_2 * \cos \theta_2 \quad (2.23)$$

$$r_3^2 * \cos^2 \theta_3 = r_1^2 + 2r_1 * r_4 * \cos \theta_4 + r_4^2 * \cos^2 \theta_4 - 2r_1 * r_2 * \cos \theta_2 - 2r_2 r_4 * \cos \theta_2 * \cos \theta_4 + r_2^2 * \cos^2 \theta_2 \quad (2.24)$$

$$r_3^2 * \sin^2 \theta_3 = r_4^2 * \sin^2 \theta_4 - 2r_2 * r_4 * \sin \theta_2 * \sin \theta_4 + r_2^2 * \sin^2 \theta_2 \quad (2.25)$$

$$r_1^2 + r_4^2 + r_2^2 - r_3^2 + 2r_1 * r_3 * \cos \theta_4 - 2r_1 * r_2 * \cos \theta_2 - 2r_2 * r_3 * \cos \theta_2 * \cos \theta_4 + \sin \theta_2 * \sin \theta_4 = 0 \mid \div (2 * r_2 * r_4) \quad (2.26)$$

$$\frac{r_1^2 + r_4^2 + r_2^2 - r_3^2}{2r_2 * r_4} + \frac{r_1}{r_2} * \cos \theta_4 - \frac{r_1}{r_4} * \cos \theta_2 - (\cos \theta_2 * \cos \theta_4 + \sin \theta_2 * \sin \theta_4) = 0 \quad (2.27)$$

Uvođenjem konstante  $k_4$ ,  $k_5$  i  $k_6$ :

$$k_4 = \frac{r_1^2 + r_2^2 + r_4^2 - r_3^2}{2 * r_2 * r_4} \quad (2.28)$$

$$k_5 = \frac{r_1}{r_2} \quad (2.29)$$

$$k_6 = \frac{r_1}{r_4} \quad (2.30)$$

Nakon uvrštavanja u jednadžbu (2.27):

$$k_4 + k_5 * \left( \frac{1 - t^2}{1 + t^2} \right) - k_6 * \cos \theta_2 - (\cos \theta_2 * \left( \frac{1 - t^2}{1 - t^2} \right) + \sin \theta_2 * \left( \frac{2t}{1 + t^2} \right)) = 0 \mid * (1 + t^2) \quad (2.31)$$

$$k_4 * (1 + t^2) + k_5 * (1 - t^2) - k_6 * \cos \theta_2 * (1 + t^2) - \cos \theta_2 * (1 - t^2) - \sin \theta_2 * 2 * t = 0 \quad (2.32)$$

Koeficijentima uz  $t^2$  pridružuje se D, uz t pridružuje se E, a ostalima F (2.33), (2.34), (2.35):

$$D = k_4 + \cos \theta_2 - k_6 * \cos \theta_2 - k_5 \quad (2.33)$$

$$E = -2 * \sin \theta_2 \quad (2.34)$$

$$F = k_4 - \cos \theta_2 - k_6 * \cos \theta_2 + k_5 \quad (2.35)$$

Na kraju se dobiva  $\theta_4$  s 2 moguća rješenja (2.36):

$$\theta_4 = 2 * \operatorname{atan}\left(\frac{-E \pm \sqrt{E^2 - 4 * D * F}}{2 * D}\right) \quad (2.36)$$

Nakon što su izračunati kutovi  $\theta_3$  i  $\theta_4$ , trigonometrijom se računaju koordinate točaka zglobova donjeg 4-segmentnog mehanizma. Točka A mehanizma se nalazi u ishodištu koordinatnog sustava i time su njezine koordinate (0, 0) u svim zakretnim položajima mehanizma. Za ostale točke koordinate se rješavaju jednostavnim trigonometrijskim jednadžbama.

$$B_x = r_2 * \cos \theta_2 \quad (2.37)$$

$$B_y = r_2 * \sin \theta_2 \quad (2.38)$$



$$C_x = B_x + r_3 * \cos \theta_3 \quad (2.39)$$

$$C_y = B_y + r_3 * \sin \theta_3 \quad (2.40)$$

$$D_x = r_1 \quad (2.41)$$

$$D_y = 0 \quad (2.42)$$

$$E_x = D_x + r_{DE} * \cos(\theta_4 - \gamma_4) \quad (2.43)$$

$$E_y = r_{DE} * \sin(\theta_4 - \gamma_4) \quad (2.44)$$

$$F_x = r_{AF} * \cos \gamma_2 \quad (2.45)$$

$$F_y = r_{AF} * \sin \gamma_2 \quad (2.46)$$

Koordinate točke G mogu se izračunati tek nakon što se odrede vrijednosti kutova  $\theta_5$  i  $\theta_6$  koje se računaju rješavanjem gornjeg 4-segmentnog mehanizma Ravenovom metodom vektorskog zbroja.

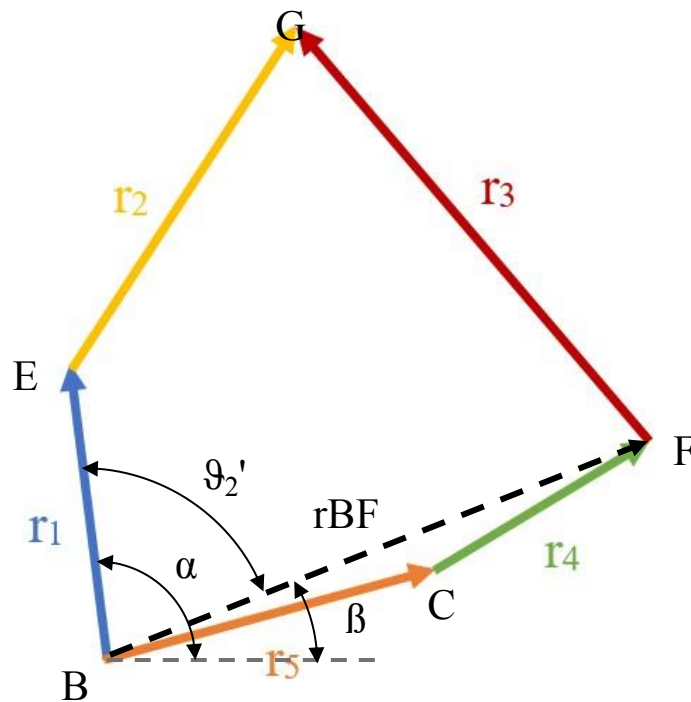

**Slika 2.6.** Vektorski zbroj gornjeg 5-članog mehanizma

Za određivanje vrijednosti kutova  $\theta_5$  i  $\theta_6$  ponoviti ćemo postupak Ravenove metode. Kako bi se moglo započeti s ovim dijelom proračuna potrebno je odrediti vrijednost unutarnjeg kuta  $\theta_2'$  (2.49) koji se dobiva preko kutova  $\alpha$  i  $\beta$  (2.47) i (2.48).

$$\alpha = \arccos \frac{E_x - D_x}{r_{DE}} \quad (2.47)$$

$$\beta = \arccos \frac{F_x - D_x}{r_{DF}} = konst. \quad (2.48)$$

$$\theta'_2 = \alpha + \beta \quad (2.49)$$

Postupak računanja je jednak kao i kod četveročlanog mehanizma gdje su koeficijenti A, B, C, D, E i F u ovom slučaju G, H, I, J, K i L a krajnja formula za kutove  $\theta_5$  i  $\theta_6$  otvorene konfiguracije mehanizma  $\theta_{51}$  (2.50) i  $\theta_{61}$  (2.51) i glasi:

$$\theta_{51} = 2 * \operatorname{atan}\left(\frac{-H + \sqrt{H^2 - 4 * G * F}}{2 * G}\right) + \beta \quad (2.50)$$

$$\theta_{61} = 2 * \operatorname{atan}\left(\frac{-K - \sqrt{K^2 - 4 * J * L}}{2 * J}\right) + \beta \quad (2.51)$$

Za zatvorenu konfiguraciju  $\theta_{52}$  (2.52) i  $\theta_{62}$  (2.53) slijedi:

$$\theta_5 = 2 * \operatorname{atan}\left(\frac{-H - \sqrt{H^2 - 4 * G * F}}{2 * G}\right) + \beta \quad (2.52)$$

$$\theta_6 = 2 * \operatorname{atan}\left(\frac{-K + \sqrt{K^2 - 4 * J * L}}{2 * J}\right) + \beta \quad (2.53)$$

Nakon izračunatih kutova mogu se dobiti koordinate točke G za obje konfiguracije mehanizma (2.54), (2.55), (2.56) i (2.57):

$$G_{x1} = F_x + r_6 * \cos \theta_{61} = E_x + r_5 * \cos \theta_{51} \quad (2.54)$$

$$G_{y1} = F_y + r_6 * \sin \theta_{61} = E_y + r_5 * \sin \theta_{51} \quad (2.55)$$

$$G_{x2} = F_x + r_6 * \cos \theta_{62} = E_x + r_5 * \cos \theta_{52} \quad (2.56)$$

$$G_{y2} = F_y + r_6 * \sin \theta_{62} = E_y + r_5 * \sin \theta_{52} \quad (2.57)$$

### 2.3. Analiza kutnih brzina

Kutne brzine elemenata se mogu izračunati raspisivanjem jednadžbe vektorskog zbroja (2.58) i deriviranjem iste (2.59):

$$r_1 * e^{i\theta_1} + r_4 * e^{i\theta_4} = r_2 * e^{i\theta_2} + r_3 * e^{i\theta_3} / d\theta \quad (2.58)$$

$$r_2 * e^{i\theta_2} * i\theta_2 + r_3 * e^{i\theta_3} * i\theta_3 = r_4 * e^{i\theta_4} * i\theta_4 \quad (2.59)$$

Raspisivanjem u trigonometrijski oblik dobiva se (2.60):

$$\begin{aligned} & * r_4 * \omega_4 * (\cos \theta_4 + i * \sin \theta_4) \\ & = i * r_2 * \omega_2 * (\cos \theta_2 + i * \sin \theta_2) + i * r_3 * \omega_3 * (\cos \theta_3 + i \\ & * \sin \theta_3) \end{aligned} \quad (2.60)$$

Daljnijm sređivanjem dobiva se jednadžba za kutnu brzinu  $\omega_4$  (2.61):

$$\omega_4 = \frac{r_2 * \omega_2 * \sin(\theta_3 - \theta_2)}{r_4 * \sin(\theta_3 - \theta_4)} \quad (2.61)$$

Istim postupkom se dobiju i ostale kutne brzine  $\omega_3$  (2.62) i kutna brzina virtualne poluge  $\omega_{2'}$  (2.63):

$$\omega_3 = \frac{r_2 * \omega_2 * \sin(\theta_4 - \theta_2)}{r_3 * \sin(\theta_3 - \theta_4)} \quad (2.62)$$

$$\omega_{2'} = \frac{r_2 * \omega_2 * \sin(\theta_3 - \theta_2)}{r_4 * \sin(\theta_3 - \theta_4)} \quad (2.63)$$

Kutne brzine otvoreno-otvorenog položaja  $\omega_{51}$  (2.64) i  $\omega_{61}$  (2.65) se dobiju istim postupkom raspisivanjem formule vektorskog zbroja gornjeg 4-segmentnog mehanizma:

$$\omega_{51} = \frac{r_{DE} * \omega_4 * \sin(\theta_{61} - \theta_2')}{r_5 * \sin(\theta_{51} - \theta_{61})} \quad (2.64)$$

$$\omega_{61} = \frac{r_{DE} * \omega_4 * \sin(\theta_{51} - \theta_2')}{r_6 * \sin(\theta_{51} - \theta_{61})} \quad (2.65)$$

Kutne brzine otvoreno-zatvorenog položaja  $\omega_{52}$  (2.66) i  $\omega_{62}$  (2.67) iznose:

$$\omega_{52} = \frac{r_{DE} * \omega_4 * \sin(\theta_{62} - \theta_2')}{r_5 * \sin(\theta_{52} - \theta_{62})} \quad (2.66)$$

$$\omega_{62} = \frac{r_{DE} * \omega_4 * \sin(\theta_{52} - \theta_2')}{r_6 * \sin(\theta_{52} - \theta_{62})} \quad (2.67)$$

## 2.4. Analiza kutnih ubrzanja

Kutna ubrzanja se dobivaju derivacijom izvoda formula za kutne brzine (2.68), (2.69).

$$i * r_4 * \omega_4 * e^{i\theta_4} = i * r_2 * \omega_2 * e^{i\theta_2} + i * r_3 * \omega_3 * e^{i\theta_3} / d\theta \quad (2.68)$$

$$\begin{aligned} i * r_4 * \varepsilon_4 * e^{i\theta_4} - r_4 * \omega_4^2 * e^{i\theta_4} \\ = i * r_2 * \varepsilon_2 * e^{i\theta_2} - r_2 * \omega_2^2 * e^{i\theta_2} + i * r_3 * \varepsilon_3 * e^{i\theta_3} - r_3 * \omega_3^2 \\ * e^{i\theta_3} \end{aligned} \quad (2.69)$$

Raspisivanjem u trigonometrijski oblik i sređivanjem jednadžbe se dobiva (2.71) i (2.72):

$$\begin{aligned} i * r_4 * \varepsilon_4 * (\cos \theta_4 + i * \sin \theta_4) - r_4 * \omega_4^2 * (\cos \theta_4 + i * \sin \theta_4) \\ = i * r_2 * \varepsilon_2 * (\cos \theta_2 + i * \sin \theta_2) - r_2 * \omega_2^2 * (\cos \theta_2 + i * \sin \theta_2) \end{aligned} \quad (2.70)$$

$$\begin{aligned} + i * r_3 * \varepsilon_3 * (\cos \theta_3 + i * \sin \theta_3) - r_3 * \omega_3^2 * (\cos \theta_3 + i * \sin \theta_3) \\ - r_4 * \varepsilon_4 * \sin \theta_4 - r_4 * \omega_4^2 * \cos \theta_4 \\ = -r_2 * \varepsilon_2 * \sin \theta_2 - r_2 * \omega_2^2 * \cos \theta_2 - r_3 * \varepsilon_3 * \sin \theta_3 - r_3 * \omega_3^2 \\ * \cos \theta_3 \end{aligned} \quad (2.71)$$

$$\begin{aligned} r_4 * \varepsilon_4 * \cos \theta_4 - r_4 * \omega_4^2 * \sin \theta_4 \\ = r_2 * \varepsilon_2 * \cos \theta_2 - r_2 * \omega_2^2 * \sin \theta_2 + r_3 * \varepsilon_3 * \cos \theta_3 - r_3 * \omega_3^2 \\ * \sin \theta_3 \end{aligned} \quad (2.72)$$

Daljnijm sređivanjem se dolazi do konačne formule za kutna ubrzanja  $\varepsilon_3$  (2.73)

i  $\varepsilon_4$  (2.74), te kutna ubrzanja virtualne poluge  $\varepsilon_2'$  (2.75):

$$\begin{aligned} \varepsilon_3 \\ = \frac{-r_2 \varepsilon_2 * \sin \theta_2 - r_2 \omega_2^2 * \cos \theta_2 - r_3 \omega_3^2 * \cos \theta_3 + r_4 \varepsilon_4 * \sin \theta_4 + r_4 \omega_4^2 * \cos \theta_4}{r_3 * \sin \theta_3} \end{aligned} \quad (2.73)$$

$$\varepsilon_4 = \frac{r_2 \omega_2^2 * \cos(\theta_3 - \theta_2) - r_2 \varepsilon_2 * \sin(\theta_3 - \theta_2) + r_3 \omega_3^2 - r_4 \omega_4^2 * \cos(\theta_3 - \theta_4)}{r_4 * \sin(\theta_4 - \theta_3)} \quad (2.74)$$

$$\varepsilon_2' = \frac{r_2 \omega_2^2 * \cos(\theta_4 - \theta_2) - r_2 \varepsilon_2 * \sin(\theta_4 - \theta_2) + r_{BF} \omega_2'^2 * \cos(\theta_4 - \theta_2') - r_4 \omega_4^2}{r_{CF} \sin(\theta_4 - \theta_2')} \quad (2.75)$$

Preostale kutna ubrzanja  $\varepsilon_{51}$  (2.76) i  $\varepsilon_{61}$  (2.77) za otvoreno-otvorenu konfiguraciju se dobiju istim postupkom deriviranjem vektorske jednadžbe kutnih brzina gornjeg 4-segmentnog mehanizma:

$$\varepsilon_{51} = \frac{r_{CE} \omega_4^2 \cos(\theta_{61} - \theta_2') - r_{CE} \varepsilon_4 \sin(\theta_{61} - \theta_2') - r_6 \omega_6^2 + r_5 \omega_5^2 \cos(\theta_{61} - \theta_{51})}{r_5 * \sin(\theta_{61} - \theta_{51})} \quad (2.76)$$

$$\varepsilon_{61} = \frac{r_{CE}\omega_4^2 \cos(\theta_{51} - \theta_2') - r_{CE}\varepsilon_4 \sin(\theta_{51} - \theta_2') + r_5\omega_5^2 - r_6\omega_6^2 \cos(\theta_{51} - \theta_{61})}{r_6 * \sin(\theta_{61} - \theta_{51})} \quad (2.77)$$

Za otvoreno-zatvorenu konfiguraciju kutnih ubrzanja  $\varepsilon_{52}$  (2.78) i  $\varepsilon_{62}$  (2.79) su:

$$\begin{aligned} \varepsilon_{52} \\ = \frac{r_{CE}\omega_4^2 \cos(\theta_{62} - \theta_2') - r_{CE}\varepsilon_4 \sin(\theta_{62} - \theta_2') - r_6\omega_6^2 + r_5\omega_5^2 \cos(\theta_{62} - \theta_{52})}{r_5 * \sin(\theta_{62} - \theta_{52})} \end{aligned} \quad (2.78)$$

$$\begin{aligned} \varepsilon_{62} \\ = \frac{r_{CE}\omega_4^2 \cos(\theta_{52} - \theta_2') - r_{CE}\varepsilon_4 \sin(\theta_{52} - \theta_2') + r_5\omega_5^2 - r_6\omega_6^2 \cos(\theta_{52} - \theta_{62})}{r_6 * \sin(\theta_{62} - \theta_{52})} \end{aligned}$$

(2.79)

### 3. DINAMIČKA ANALIZA

Dinamika je grana mehanike koja analizira gibanje tijela i povezuje ih sa silama koje djeluju na njega. Dinamičkom analizom za poznate položaje točaka, brzine i ubrzanja možemo dobiti sile i momente zbog kojih se mehanizam giba. Za izračunavanje sila, potrebne su nam koordinate težišta svih elemenata mehanizma jer se pretpostavlja da je u težištu koncentrirana cjelokupna masa svih čestica tijela.

#### 3.1. Težišta elemenata mehanizma

Wattov mehanizam sastoji od 5 različitih elemenata spojenih zglobovima prikazanim na slici 3.1.

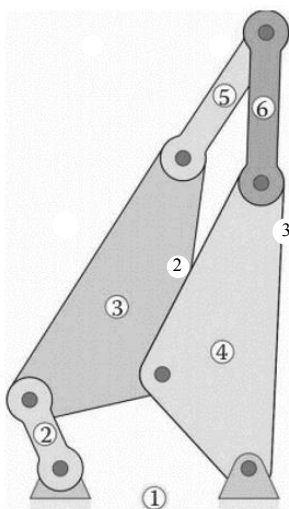

*Slika 3.1. Segmenti Wattovog I. mehanizma*

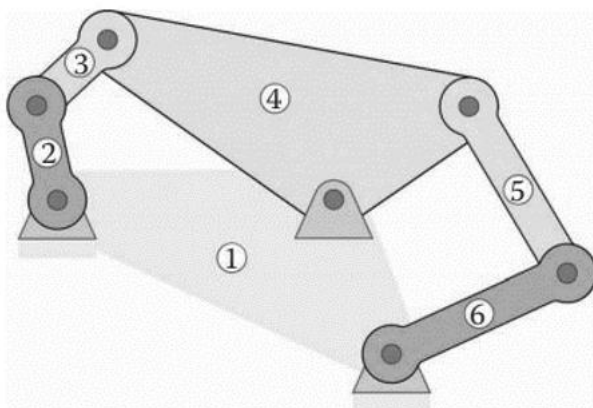

*Slika 3.2. Segmenti Wattovog II. mehanizma*

Težište elementa oblika trokutaste ploče se dobiva zbrajanjem koordinata kutova i dijeljenjem tog broja s 3 (što predstavlja broj kutova ploče), dok se težište poluge dobije zbrojem koordinata točaka zglobova i dijeljenjem s 2.

$$T_{2x} = \frac{A_x + B_x}{2} \quad (3.1)$$

$$T_{2y} = \frac{A_y + B_y}{2} \quad (3.2)$$

$$T_{3x} = \frac{B_x + C_x + E_x}{3} \quad (3.3)$$

$$T_{3y} = \frac{B_y + C_y + E_y}{3} \quad (3.4)$$

$$T_{4x} = \frac{C_x + D_x + F_x}{3} \quad (3.5)$$

$$T_{4y} = \frac{C_y + D_y + F_y}{3} \quad (3.6)$$

$$T_{51x} = \frac{E_x + G_{x1}}{2} \quad (3.7)$$

$$T_{51y} = \frac{E_y + G_{y1}}{2} \quad (3.8)$$

$$T_{52x} = \frac{E_x + G_{x2}}{2} \quad (3.9)$$

$$T_{52y} = \frac{E_y + G_{y2}}{2} \quad (3.10)$$

$$T_{61x} = \frac{F_x + G_{x1}}{2} \quad (3.11)$$

$$T_{61y} = \frac{F_y + G_{y1}}{2} \quad (3.12)$$

$$T_{62x} = \frac{F_x + G_{x2}}{2} \quad (3.13)$$

$$T_{62y} = \frac{F_y + G_{y2}}{2} \quad (3.14)$$

### 3.2. Ubrzanja težišta

Brzine točaka težišta dobivaju se derivacijom vektorske jednadžbe položaja točaka težišta.

Daljnjom deriviranjem brzina dobivaju se jednadžbe za ubrzanja točaka težišta.

*Slika 3.2. Vektori položaja točaka težišta*

$$a_{2x} = -g_2\omega_2^2\cos(\theta_2 + \varphi_1) - g_2\varepsilon_{20}\sin(\theta_2 + \varphi_1) \quad (3.15)$$

$$a_{2y} = -g_2\omega_2^2\sin(\theta_2 + \varphi_1) + g_2\varepsilon_{20}\cos(\theta_2 + \varphi_1) \quad (3.16)$$

$$a_{3x} = -r_2\omega_2^2\cos(\theta_2) - r_2\varepsilon_{20}\sin(\theta_2) - g_3\omega_3^2\cos(\theta_3) - g_3\varepsilon_3\sin(\theta_3) \quad (3.17)$$

$$a_{3y} = -r_2\omega_2^2\sin(\theta_2) + r_2\varepsilon_{20}\cos(\theta_2) - g_3\omega_3^2\sin(\theta_3) + g_3\varepsilon_3\cos(\theta_3) \quad (3.18)$$

$$a_{4x} = -g_4\omega_4^2\cos(\theta_4 + \pi - \varphi_2) - g_4\varepsilon_4\sin(\theta_4 + \pi - \varphi_2) \quad (3.19)$$

$$a_{4y} = -g_4\omega_4^2\sin(\theta_4 + \pi - \varphi_2) + g_4\varepsilon_4\cos(\theta_4 + \pi - \varphi_2) \quad (3.20)$$

$$a_{51x} = -r_{AE}\omega_2^2\cos(\theta_2 + \gamma_2) - r_{AE}\varepsilon_{20}\sin(\theta_2 + \gamma_2) - g_5\omega_{51}^2\cos(\theta_{51}) - g_5\varepsilon_{51}\sin(\theta_{51}) \quad (3.21)$$

$$a_{51y} = -r_{AE}\omega_2^2\sin(\theta_2 + \gamma_2) + r_{AE}\varepsilon_{20}\cos(\theta_2 + \gamma_2) - g_5\omega_{51}^2\sin(\theta_{51}) + g_5\varepsilon_{51}\cos(\theta_{51}) \quad (3.22)$$

$$a_{61x} = -r_{DF}\omega_4^2\cos(\theta_4 - \gamma_2) - r_{DF}\varepsilon_4\sin(\theta_4 - \gamma_2) - g_6\omega_{61}^2\cos(\theta_{61} + \pi) - g_6\varepsilon_{61}\sin(\theta_{61} + \pi) \quad (3.23)$$

$$a_{61y} = -r_{DF}\omega_4^2\sin(\theta_4 - \gamma_2) + r_{DF}\varepsilon_4\cos(\theta_4 - \gamma_2) - g_6\omega_{61}^2\sin(\theta_{61} + \pi) + g_6\varepsilon_{61}\cos(\theta_{61} + \pi) \quad (3.24)$$

$$a_{52x} = -r_{AE}\omega_2^2\cos(\theta_2 + \gamma_2) - r_{AE}\varepsilon_{20}\sin(\theta_2 + \gamma_2) - g_5\omega_{52}^2\cos(\theta_{52}) - g_5\varepsilon_{52}\sin(\theta_{52}) \quad (3.25)$$

$$a_{52y} = -r_{AE}\omega_2^2\sin(\theta_2 + \gamma_2) + r_{AE}\varepsilon_{20}\cos(\theta_2 + \gamma_2) - g_5\omega_{52}^2\sin(\theta_{52}) + g_5\varepsilon_{52}\cos(\theta_{52}) \quad (3.26)$$

$$a_{62x} = -r_{DF}\omega_4^2\cos(\theta_4 - \gamma_2) - r_{DF}\varepsilon_4\sin(\theta_4 - \gamma_2) - g_6\omega_{62}^2\cos(\theta_{62} + \pi) - g_6\varepsilon_{62}\sin(\theta_{62} + \pi) \quad (3.27)$$

$$a_{62y} = -r_{DF}\omega_4^2\sin(\theta_4 - \gamma_2) + r_{DF}\varepsilon_4\cos(\theta_4 - \gamma_2) - g_6\omega_{62}^2\sin(\theta_{62} + \pi) + g_6\varepsilon_{62}\cos(\theta_{62} + \pi) \quad (3.28)$$



### 3.3. Inercijske sile

Inercijske sile se suprotstavljaju promjeni gibanja tijela. Za određivanje inercijskih sila moraju biti poznate mase segmenata i ubrzanja težišta. U ovom su radu uzete slijedeće mase segmenata:

$$m_2 = 0.2 \text{ kg}$$

$$m_3 = 0.1 \text{ kg}$$

$$m_4 = 0.2 \text{ kg}$$

$$m_5 = 0.1 \text{ kg}$$

$$m_6 = 0.1 \text{ kg}$$

Izrazi za komponente inercijskih sila segmenata u smjeru koordinatnih osi glase:

$$F_{in2x} = -m_2 a_{2x} \quad (3.29)$$

$$F_{in2y} = -m_2 a_{2y} \quad (3.30)$$

$$F_{in3x} = -m_3 a_{3x} \quad (3.31)$$

$$F_{in3y} = -m_3 a_{3y} \quad (3.32)$$

$$F_{in4x} = -m_4 a_{4x} \quad (3.33)$$

$$F_{in4y} = -m_4 a_{4y} \quad (3.34)$$

$$F_{in51x} = -m_5 a_{51x} \quad (3.35)$$

$$F_{in51y} = -m_5 a_{51y} \quad (3.36)$$

$$F_{in61x} = -m_6 a_{61x} \quad (3.37)$$

$$F_{in61y} = -m_6 a_{61y} \quad (3.38)$$

$$F_{in52x} = -m_5 a_{52x} \quad (3.39)$$

$$F_{in52y} = -m_5 a_{52y} \quad (3.40)$$

$$F_{in62x} = -m_6 a_{62x} \quad (3.41)$$

$$F_{in62y} = -m_6 a_{62y} \quad (3.42)$$

### 3.4. Maseni momenti tromosti

Za izračunavanje inercijskih momenata svakog segmenta mehanizma, potrebno je izračunati njihove masene momente tromosti koji iznose:

$$J_2 = \frac{m_2 r_2}{12} \quad (3.43)$$

$$J_3 = \frac{m_3}{72} * (3r_{BE} + 4(r_2 \sin(\gamma_2)))^2 \quad (3.44)$$

$$J_4 = \frac{m_4}{72} * (3r_{DF} + 4(r_4 \sin(\gamma_4)))^2 \quad (3.45)$$

$$J_5 = \frac{m_5 r_5}{12} \quad (3.46)$$

$$J_6 = \frac{m_6 r_6}{12} \quad (3.47)$$

Prema tome su inercijski momenti:

$$M_{in2} = -J_2 \varepsilon_{20} \quad (3.48)$$

$$M_{in3} = -J_3 \varepsilon_3 \quad (3.49)$$

$$M_{in4} = -J_4 \varepsilon_4 \quad (3.50)$$

$$M_{in51} = -J_5 \varepsilon_{51} \quad (3.51)$$

$$M_{in61} = -J_6 \varepsilon_{61} \quad (3.52)$$

$$M_{in52} = -J_5 \varepsilon_{52} \quad (3.53)$$

$$M_{in62} = -J_6 \varepsilon_{62} \quad (3.54)$$

### 3.5. Analiza sila

Sile koje se javljaju u zglobovima pri zaokretanju mehanizma, te okretni moment motora  $T_2$  potreban za savladavanje svih sila Stephensonovog I. tipa mehanizma računa se raspisivanjem sila po x i y osi te momenata po z osi za svaki segment kao što je prikazano na slici 3.3.

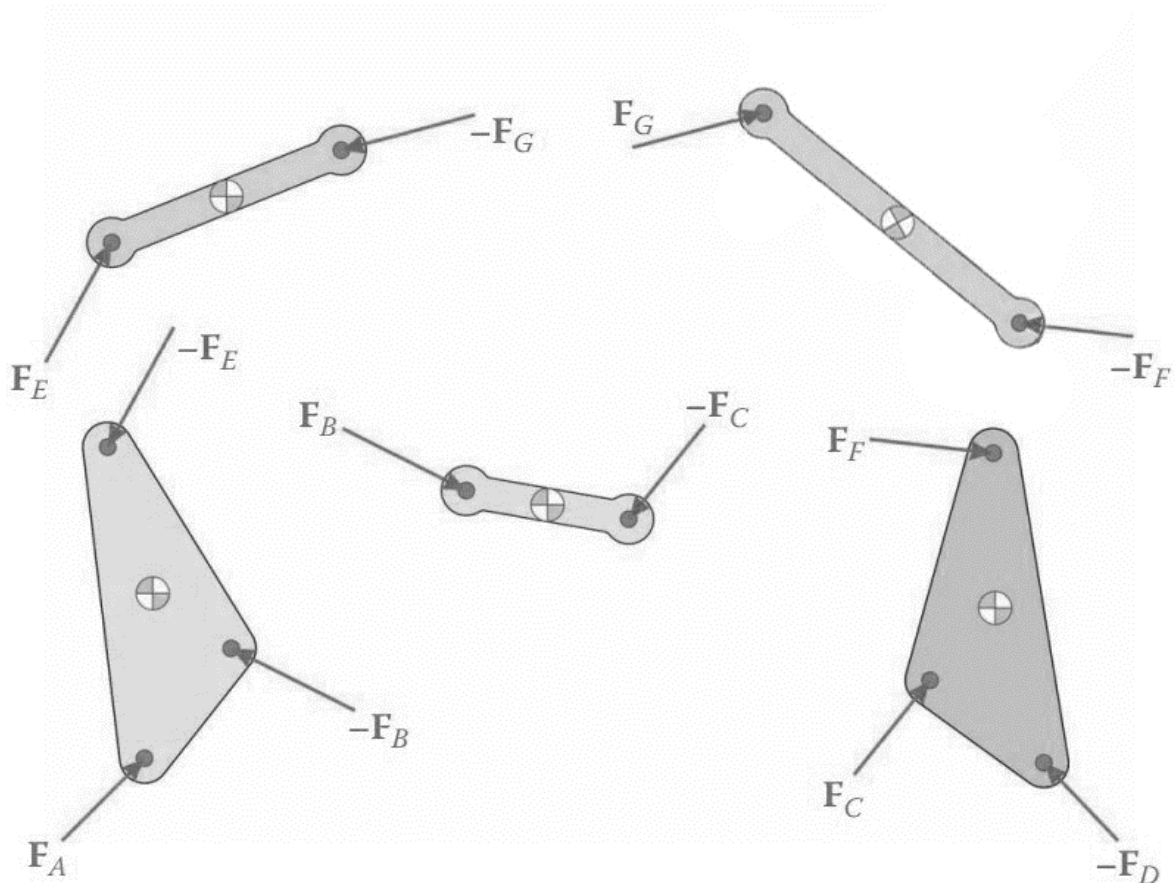

*Slika 3.3. Sile koje se javljaju u pojedinim segmentima*

Za prvi segment vrijedi:

- sile:

$$F_{ax} - F_{bx} = m_2 a_{2x} \quad (3.55)$$

$$F_{ay} - F_{by} = m_2 a_{2y} \quad (3.56)$$

- moment:

$$s_{2a} F_a - s_{2b} F_b = J_2 \varepsilon_2 \quad (3.57)$$

Drugi segment:

- sile:

$$F_{bx} - F_{cx} - F_{ex} = m_3 a_{3x} \quad (3.58)$$

$$F_{by} - F_{cy} - F_{ey} = m_3 a_{3y} \quad (3.59)$$

- moment:

$$s_{3b}F_b - s_{3c}F_c - s_{3e}F_e - T_3 = J_3 \varepsilon_3 \quad (3.60)$$

Treći segment:

- sile:

$$F_{cx} - F_{dx} - F_{fx} = m_4 a_{4x} \quad (3.61)$$

$$F_{cy} - F_{dy} - F_{fy} = m_4 a_{4y} \quad (3.62)$$

- moment:

$$s_{4c}F_c - s_{4d}F_d - s_{4f}F_f - T_4 = J_4 \varepsilon_4 \quad (3.63)$$

Četvrti segment:

- sile:

$$F_{ex} - F_{gx} = m_5 a_{5x} \quad (3.64)$$

$$F_{ey} - F_{gy} = m_5 a_{5y} \quad (3.65)$$

- moment:

$$s_{5e}F_e - s_{5g}F_g = J_5 \varepsilon_5 \quad (3.66)$$

Peti segment:

- sile:

$$F_{gx} - F_{fx} = m_6 a_{6x} \quad (3.67)$$

$$F_{gy} - F_{fy} = m_6 a_{6y} \quad (3.68)$$

- moment:

$$s_{6g}F_g - s_{6f}F_f = J_6 \varepsilon_6 \quad (3.69)$$

Kraskovi sila ( $s_{2a}$ ,  $s_{2b}$ ,  $s_{2e}$ , itd.) se dobiju vektorskim produktom vektora „ $r$ “ i sila u zglobovima (3.70) kao što je prikazano na slici 3.4.

$$s = r \times F = \begin{bmatrix} \vec{i} & \vec{j} & \vec{k} \\ r_x & r_y & 0 \\ F_x & F_y & 0 \end{bmatrix} = (r_x F_y - r_y F_x) \vec{k} \quad (3.70)$$

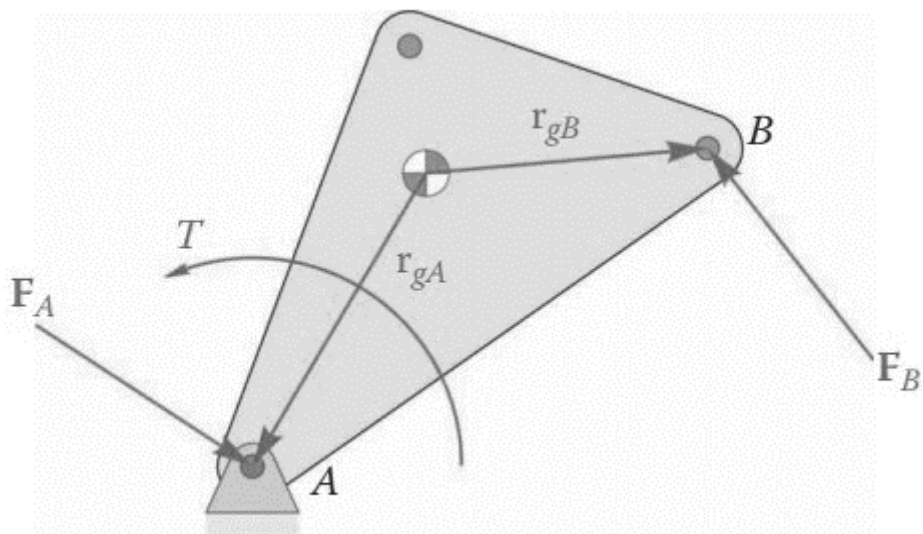

**Slika 3.4.** Vektor „r“ i sile u zglobovima

Naposlijetku se sve dobivene jednačbe sile unose u zajedničku matricu  $\mathbf{Sf} = \mathbf{t}$ .

U matrici  $\mathbf{S}$  se nalaze geometrijski parametri (3.71):

$$\mathbf{S} = \begin{bmatrix}
 1 & 0 & -1 & 0 & 0 & 0 & 0 & 0 & -1 & 0 & 0 & 0 & 0 & 0 & 0 \\
 0 & 1 & 0 & -1 & 0 & 0 & 0 & 0 & 0 & -1 & 0 & 0 & 0 & 0 & 0 \\
 0 & 0 & 1 & 0 & -1 & 0 & 0 & 0 & 0 & 0 & 0 & 0 & 0 & 0 & 0 \\
 0 & 0 & 0 & 1 & 0 & -1 & 0 & 0 & 0 & 0 & 0 & 0 & 0 & 0 & 0 \\
 0 & 0 & 0 & 0 & 1 & 0 & -1 & 0 & 0 & 0 & 1 & 0 & 0 & 0 & 0 \\
 0 & 0 & 0 & 0 & 0 & 1 & 0 & -1 & 0 & 0 & 0 & 1 & 0 & 0 & 0 \\
 0 & 0 & 0 & 0 & 0 & 0 & 0 & 0 & 1 & 0 & 0 & 0 & -1 & 0 & 0 \\
 0 & 0 & 0 & 0 & 0 & 0 & 0 & 0 & 0 & 1 & 0 & 0 & 0 & -1 & 0 \\
 0 & 0 & 0 & 0 & 0 & 0 & 0 & 0 & 0 & 0 & -1 & 0 & 1 & 0 & 0 \\
 0 & 0 & 0 & 0 & 0 & 0 & 0 & 0 & 0 & 0 & 0 & -1 & 0 & 1 & 0 \\
 s_{2ay} & s_{2ax} & s_{2by} & s_{2bx} & 0 & 0 & 0 & 0 & s_{2ey} & s_{2ex} & 0 & 0 & 0 & 0 & 1 \\
 0 & 0 & s_{3by} & s_{3bx} & s_{3cy} & s_{3cx} & 0 & 0 & 0 & 0 & 0 & 0 & 0 & 0 & 0 \\
 0 & 0 & 0 & 0 & s_{4cy} & s_{4cx} & s_{4dy} & s_{4dx} & 0 & 0 & s_{4fy} & s_{4fx} & 0 & 0 & 0 \\
 0 & 0 & 0 & 0 & 0 & 0 & 0 & 0 & s_{51ey} & s_{51ex} & 0 & 0 & s_{51gy} & s_{51gx} & 0 \\
 0 & 0 & 0 & 0 & 0 & 0 & 0 & 0 & 0 & 0 & s_{61fy} & s_{61fx} & s_{61gy} & s_{61gx} & 0
 \end{bmatrix} \quad (3.71)$$

Vektor  $\mathbf{f}$  predstavlja sve sile unutar mehanizma (3.72):

$$\mathbf{f} = \begin{bmatrix} F_{ax} \\ F_{ay} \\ F_{bx} \\ F_{by} \\ F_{cx} \\ F_{cy} \\ F_{dx} \\ F_{dy} \\ F_{ex} \\ F_{ey} \\ F_{fx} \\ F_{fy} \\ F_{gx} \\ F_{gy} \\ T_2 \end{bmatrix} \quad (3.72)$$

$\mathbf{t}$  je vektor inercijalnih sila i momenata (3.73):

$$\mathbf{t} = \begin{bmatrix} m_2 a_{2x} \\ m_2 a_{2y} \\ m_3 a_{3x} \\ m_3 a_{3y} \\ m_4 a_{4x} \\ m_4 a_{4y} \\ m_5 a_{5x} \\ m_5 a_{5y} \\ m_6 a_{6x} \\ m_6 a_{6y} \\ J_2 \varepsilon_2 \\ J_3 \varepsilon_3 \\ J_4 \varepsilon_4 \\ J_5 \varepsilon_5 \\ J_6 \varepsilon_6 \end{bmatrix} \quad (3.73)$$

Za određivanje vrijednosti nepoznatih sila pogonskog momenta potrebno je riješiti nepoznati vektor  $\mathbf{f}$  (3.74):

$$\mathbf{f} = [\mathbf{S}]^{-1} \mathbf{t} \quad (3.74)$$

## 4. MODELIRANJE WATTOVIG I. TIPA MEHANIZMA U MICROSOFT EXCEL-U

Analiza Watoovog I. tipa mehanizma u Microsofot Office Excel-u započinje unošenjem ulaznih podataka mehanizma. Za potpunu sliku promjena položaja, brzina i ubrzanja, te ostalih varijabli pri potpunom okretu mehanizma, računati će se varijable za svakih  $9^\circ$  promjene kuta  $\vartheta_2$  pogonske ploče. Pri tome se dobiva 41 položaja, kutova koja se u Excel-u prikazuje u tablici.

r1 (mm)	r2 (mm)	r3 (mm)	r4 (mm)	rBE (mm)	rDF (mm)	r5 (mm)	r6 (mm)	y3 (deg)	y4 (deg)	θ1 (deg)	ω20	ε2	t1	t2	broj podjela u vremenu
132	84	120	108	180	180	120	120	30	50	0	1	1	4,683255	-2,68326	60
								y3 (rad)	y3 (rad)	θ1 (rad)					
								0,523599	0,872665	0					

**Slika 4.1.** Ulazni podaci Wattovog I. tipa mehanizma

### 4.1. Analiza položaja

Nakon definiranja poznatih dimenzija, računaju se položaji točaka zglobova donjeg 4-segmentnog mehanizma uvrštavanje formula u odgovarajuće ćelije. Radi jednostavnijeg zapisa koristimo konstante  $k_1$ ,  $k_2$ ,  $k_3$ ,  $k_4$ ,  $k_5$  i  $k_6$ , te se pomoću njih dobivaju konstante A, B, C, D, E i F ovisne o kutu pogonske ploče,  $\vartheta_2$ . Uvođenjem formula za kinematičku analizu dobivamo kutove  $\vartheta_{31}$ ,  $\vartheta_{32}$ ,  $\vartheta_{41}$  i  $\vartheta_{42}$ .

k1	k2	k3	k4	k5	k6
1,35	1,1	1,571429	1,198413	1,571429	1,222222

**Slika 4.2.** Konstante

$\theta_2$ [rad]	$\theta_2$ [st]	A	B	C	D	E	F
0	0	0,821429	0	-0,32143	-0,59524	0	0,547619
0,15708	9	0,847283	0,312869	-0,3202	-0,5925	-0,31287	0,574978
0,314159	18	0,92421	0,618034	-0,31653	-0,58436	-0,61803	0,656382
0,471239	27	1,050315	0,907981	-0,31053	-0,57102	-0,90798	0,789827
0,628319	36	1,222493	1,175571	-0,30233	-0,5528	-1,17557	0,972026
0,785398	45	1,436504	1,414214	-0,29214	-0,53015	-1,41421	1,198493
0,942478	54	1,68708	1,618034	-0,28021	-0,50363	-1,61803	1,463652
1,099557	63	1,968049	1,782013	-0,26683	-0,4739	-1,78201	1,760973
1,256637	72	2,272493	1,902113	-0,25233	-0,44169	-1,90211	2,083137
1,413717	81	2,592916	1,975377	-0,23707	-0,40778	-1,97538	2,422209
1,570796	90	2,921429	2	-0,22143	-0,37302	-2	2,769841
1,727876	99	3,249941	1,975377	-0,20579	-0,33825	-1,97538	3,117473
1,884956	108	3,570364	1,902113	-0,19053	-0,30435	-1,90211	3,456546
2,042035	117	3,874809	1,782013	-0,17603	-0,27213	-1,78201	3,778709
2,199115	126	4,155778	1,618034	-0,16265	-0,2424	-1,61803	4,076031
2,356194	135	4,406353	1,414214	-0,15072	-0,21588	-1,41421	4,34119
2,513274	144	4,620364	1,175571	-0,14053	-0,19323	-1,17557	4,567657
2,670354	153	4,792542	0,907981	-0,13233	-0,17501	-0,90798	4,749856
2,827433	162	4,918647	0,618034	-0,12632	-0,16167	-0,61803	4,8833
2,984513	171	4,995574	0,312869	-0,12266	-0,15353	-0,31287	4,964704
3,141593	180	5,021429	2,45E-16	-0,12143	-0,15079	-2,5E-16	4,992063
3,298672	189	4,995574	-0,31287	-0,12266	-0,15353	0,312869	4,964704
3,455752	198	4,918647	-0,61803	-0,12632	-0,16167	0,618034	4,8833
3,612832	207	4,792542	-0,90798	-0,13233	-0,17501	0,907981	4,749856
3,769911	216	4,620364	-1,17557	-0,14053	-0,19323	1,175571	4,567657
3,926991	225	4,406353	-1,41421	-0,15072	-0,21588	1,414214	4,34119
4,08407	234	4,155778	-1,61803	-0,16265	-0,2424	1,618034	4,076031
4,24115	243	3,874809	-1,78201	-0,17603	-0,27213	1,782013	3,778709
4,39823	252	3,570364	-1,90211	-0,19053	-0,30435	1,902113	3,456546
4,555309	261	3,249941	-1,97538	-0,20579	-0,33825	1,975377	3,117473
4,712389	270	2,921429	-2	-0,22143	-0,37302	2	2,769841
4,869469	279	2,592916	-1,97538	-0,23707	-0,40778	1,975377	2,422209
5,026548	288	2,272493	-1,90211	-0,25233	-0,44169	1,902113	2,083137
5,183628	297	1,968049	-1,78201	-0,26683	-0,4739	1,782013	1,760973
5,340708	306	1,68708	-1,61803	-0,28021	-0,50363	1,618034	1,463652
5,497787	315	1,436504	-1,41421	-0,29214	-0,53015	1,414214	1,198493
5,654867	324	1,222493	-1,17557	-0,30233	-0,5528	1,175571	0,972026
5,811946	333	1,050315	-0,90798	-0,31053	-0,57102	0,907981	0,789827
5,969026	342	0,92421	-0,61803	-0,31653	-0,58436	0,618034	0,656382
6,126106	351	0,847283	-0,31287	-0,3202	-0,5925	0,312869	0,574978
6,283185	360	0,821429	-4,9E-16	-0,32143	-0,59524	4,9E-16	0,547619

Slika 4.3. Konstante ovisne o kutu pogonske ploče,  $\vartheta_2$

$\theta_3$ [rad]	$\theta_3$ [rad]	$\theta_3$ [st]	$\theta_3$ [st]
1,11798	-1,11798	64,05552	-64,0555
0,857718	-1,38139	49,14364	-79,1476
0,65485	-1,57913	37,52013	-90,4773
0,513174	-1,68994	29,40272	-96,8267
0,415739	-1,7293	23,8201	-99,0813
0,347158	-1,71853	19,8907	-98,4643
0,297359	-1,67394	17,0374	-95,9099
0,260183	-1,60645	14,90738	-92,0427
0,231866	-1,52317	13,28495	-87,2711
0,210073	-1,42886	12,03632	-81,8676
0,193349	-1,32681	11,0781	-76,0205
0,180814	-1,2194	10,3599	-69,8666
0,172003	-1,10849	9,855033	-63,5121
0,16679	-0,99566	9,556335	-57,0469
0,165383	-0,88237	9,475739	-50,5558
0,168374	-0,77019	9,647091	-44,1289
0,17684	-0,661	10,13216	-37,8725
0,192489	-0,55713	11,02881	-31,921
0,217749	-0,46154	12,47609	-26,4445
0,25556	-0,37766	14,6425	-21,6386
0,308541	-0,30854	17,67807	-17,6781
0,377664	-0,25556	21,63858	-14,6425
0,461544	-0,21775	26,44452	-12,4761
0,557127	-0,19249	31,92104	-11,0288
0,661	-0,17684	37,87249	-10,1322
0,770194	-0,16837	44,12887	-9,64709
0,882365	-0,16538	50,55581	-9,47574
0,995656	-0,16679	57,04689	-9,55633
1,108495	-0,172	63,51207	-9,85503
1,219402	-0,18081	69,86656	-10,3599
1,326808	-0,19335	76,02048	-11,0781
1,42886	-0,21007	81,86762	-12,0363
1,523168	-0,23187	87,27112	-13,285
1,606448	-0,26018	92,04268	-14,9074
1,673944	-0,29736	95,90993	-17,0374
1,718526	-0,34716	98,4643	-19,8907
1,729295	-0,41574	99,08133	-23,8201
1,689944	-0,51317	96,82666	-29,4027
1,579128	-0,65485	90,47735	-37,5201
1,381387	-0,85772	79,14763	-49,1436
1,11798	-1,11798	64,05552	-64,0555

Slika 4.4. Promjena kuta  $\vartheta_3$  u ovisnosti o  $\vartheta_2$



$\theta_{41}$ [rad]	$\theta_{42}$ [rad]	$\theta_{41}$ [st]	$\theta_{42}$ [st]
1,529118	-1,52912	87,61198	-87,612
1,294463	-1,81813	74,16728	-104,171
1,160638	-2,08492	66,49966	-119,457
1,116564	-2,29333	63,97442	-131,398
1,133515	-2,44707	64,94565	-140,207
1,189013	-2,56038	68,12544	-146,699
1,26894	-2,64553	72,70493	-151,577
1,364745	-2,71101	78,19416	-155,329
1,47113	-2,76243	84,28955	-158,276
1,584664	-2,80345	90,79454	-160,626
1,702996	-2,83645	97,57451	-162,517
1,824402	-2,86299	104,5305	-164,037
1,947496	-2,88399	111,5833	-165,24
2,071034	-2,8999	118,6615	-166,152
2,193752	-2,91073	125,6927	-166,773
2,314198	-2,91602	132,5938	-167,076
2,430539	-2,9147	139,2596	-167
2,540357	-2,905	145,5517	-166,444
2,640502	-2,8843	151,2896	-165,258
2,727297	-2,8494	156,2626	-163,259
2,797429	-2,79743	160,2809	-160,281
2,849401	-2,7273	163,2587	-156,263
2,884297	-2,6405	165,2581	-151,29
2,904995	-2,54036	166,444	-145,552
2,914699	-2,43054	167	-139,26
2,916018	-2,3142	167,0755	-132,594
2,910734	-2,19375	166,7728	-125,693
2,8999	-2,07103	166,1521	-118,661
2,883988	-1,9475	165,2403	-111,583
2,862989	-1,8244	164,0372	-104,531
2,836455	-1,703	162,5169	-97,5745
2,80345	-1,58466	160,6258	-90,7945
2,762432	-1,47113	158,2757	-84,2895
2,71101	-1,36475	155,3295	-78,1942
2,645526	-1,26894	151,5775	-72,7049
2,560381	-1,18901	146,699	-68,1254
2,447072	-1,13352	140,2069	-64,9457
2,293334	-1,11656	131,3984	-63,9744
2,084916	-1,16064	119,4569	-66,4997
1,818132	-1,29446	104,1713	-74,1673
1,529118	-1,52912	87,61198	-87,612

Slika 4.5. Promjena kuta  $\vartheta_4$  u ovisnosti o kutu  $\vartheta_2$

Odredivši kutove,  $\vartheta_{31}$ ,  $\vartheta_{32}$ ,  $\vartheta_{41}$  i  $\vartheta_{42}$ , možemo izračunati koordinate točaka donjeg 4-segmentnog mehanizma prema formulama iz kinematičke analize.

Ax	Ay	Bx	By	Cx1	Cy1	Dx	Dy	Ex1	Ey1	Fx1	Fy1	Cx2	Cy2	Ex2	Ey2	Fx2	Fy2
0	0	84	0	136,5	107,9062	132	0	71,26984	179,5493	274,5892	109,856	136,5	-107,906	233,1292	-100,799	-94,9735	-121,347
0	82,96582	13,1405	161,4656	103,9027	132	0	116,8684	189,9189	296,2237	73,69238	105,5599	-104,713	200,706	-123,011	-30,0181	-78,4229	
0	79,88875	25,95743	175,0655	99,04232	132	0	148,7133	192,799	309,5279	53,132	78,889	-94,0384	168,5869	-130,672	-44,9611	-32,9356	
0	74,84455	38,1352	179,3874	97,04861	132	0	166,4647	193,0731	306,6727	43,46797	60,58063	-81,014	145,6771	-127,342	-47,9464	4,392653	
0	67,95743	49,37396	177,7356	97,8379	132	0	174,2155	194,6641	305,9108	46,42249	49,01707	-69,1219	132,2251	-118,762	-45,1514	31,89655	
0	59,39697	59,39697	172,2382	100,2242	132	0	175,3616	197,064	303,068	55,99773	41,73379	-59,296	125,4715	-108,037	-40,4089	51,72203	
0	49,37396	67,95743	164,1076	103,1169	132	0	172,0477	199,6812	298,0509	69,47739	37,01816	-51,4048	122,845	-96,3655	-35,3858	66,1966	
0	38,1352	74,84455	154,0964	105,7154	132	0	165,62	201,9179	290,6433	85,04296	33,85793	-45,0792	122,5217	-84,1489	-30,6953	77,00806	
0	25,95743	79,88875	142,7461	107,464	132	0	156,9889	203,3016	280,7162	101,4076	31,67061	-39,9752	123,277	-71,5342	-26,5221	85,2687	
0	13,1405	82,96582	130,5024	107,9896	132	0	146,8302	205,4941	268,2703	117,6027	30,11578	-35,8274	124,287	-58,6197	-22,8922	91,69734	
0	5,15615	84	117,7639	107,0576	132	0	135,6866	202,2757	253,4336	132,8679	28,989	-32,4459	124,9922	-45,5259	-17,819	96,75868	
0	-13,1405	82,96582	104,9032	104,5455	132	0	124,018	199,5314	236,4484	146,5965	28,16443	-29,7014	125,0166	-32,4145	-17,1614	100,7516	
0	-25,9574	79,88875	92,27185	100,4275	132	0	112,2229	195,2413	217,6586	158,3118	27,56369	-27,5147	124,1211	-19,4915	-15,013	103,8613	
0	-38,1352	74,84455	80,19954	94,76662	132	0	100,6446	189,4751	197,4979	167,6604	27,13909	-25,8494	122,179	-7,00498	-13,3418	106,1874	
0	-49,374	67,95743	68,98869	87,71302	132	0	89,56693	182,3927	176,482	174,4172	26,8652	-24,7118	119,1656	4,755912	-12,1828	107,7558	
0	-59,397	59,39697	58,90607	79,50646	132	0	79,20107	174,2472	155,2027	178,4983	26,7361	-24,156	115,1579	15,45831	-11,6115	108,5161	
0	-67,9574	49,37396	50,17112	70,48429	132	0	69,6632	165,3935	134,3258	179,985	26,76805	-24,2948	110,3461	24,71956	-11,7545	108,3266	
0	-74,8445	38,1352	42,93919	61,0915	132	0	60,94379	156,2341	114,586	179,1557	27,00876	-25,3148	105,0543	32,1012	-12,7989	106,9265	
0	-79,8887	25,95743	37,2776	51,88128	132	0	52,87191	147,5083	96,76164	176,517	27,55517	-27,4823	99,76479	37,12012	-14,9809	103,9068	
0	-82,9658	13,1405	33,13681	43,47494	132	0	45,10509	139,6231	81,59284	172,7979	28,57759	-31,1096	95,12086	39,31554	-15,5166	98,71553	
0	-84	1,03E-14	30,33333	36,44021	132	0	37,1932	133,0872	69,60791	168,8408	30,33333	-36,4402	91,85351	38,41278	-23,4415	90,76312	
0	-82,9658	-13,1405	28,57759	31,10956	132	0	28,74578	127,9996	60,92111	165,3717	33,13681	-43,4749	90,60676	34,53088	-29,4196	79,64741	
0	-79,8887	-25,9574	27,55517	27,48231	132	0	19,60519	124,0458	55,19471	162,7911	37,2776	-51,8813	91,7577	28,24126	-35,7163	65,35487	
0	-74,8445	-38,1352	27,00876	25,31481	132	0	18,97923	120,6788	51,842	161,1667	42,93919	-61,0915	95,37824	20,38149	-41,41	48,29947	
0	-67,9574	-49,374	26,76805	24,29478	132	0	-0,15698	117,3887	50,28182	160,3812	50,17112	-70,4843	101,3288	11,79933	-45,6545	28,96355	
0	-59,397	-59,397	26,7361	24,15597	132	0	-10,1715	113,7413	50,07036	160,2733	58,90607	-79,5065	109,3653	3,207315	-47,8156	8,145725	
0	-49,374	-67,9574	26,8652	24,71182	132	0	-19,8383	109,6028	50,91835	160,704	68,98869	-87,713	119,2003	-4,84871	-47,4916	-13,519	
0	-38,1352	-74,8445	27,13909	25,84938	132	0	-28,8618	104,9164	52,66413	161,573	80,19954	-94,7666	130,5277	-11,973	-44,4869	35,3889	
0	-25,9574	-79,8887	27,56369	27,51465	132	0	-36,984	99,7732	55,24513	162,8149	92,27185	-100,427	143,0309	-17,8974	-38,7811	-56,8667	
0	-13,1405	-82,9658	28,16443	29,7014	132	0	-43,9842	94,37189	58,68062	164,3906	104,9032	-104,546	156,3875	22,4659	-30,5066	-77,4054	
0	-1,5E-14	-84	28,989	32,44586	132	0	49,6766	89,00936	63,06796	166,278	117,7639	-107,058	170,2731	25,6298	-19,9361	-96,5164	
0	13,1405	-82,9658	30,11578	35,82744	132	0	-53,9029	84,08262	68,5925	168,4621	130,5024	-107,99	184,3659	-27,4513	7,74917	-113,779	
0	25,95743	-79,8887	31,67061	39,97517	132	0	-56,5189	80,10394	75,55379	170,2025	142,7461	-107,464	198,3519	-28,1186	6,308753	-128,848	
0	38,1352	-74,8445	33,85793	45,0792	132	0	-57,3639	77,73301	84,4136	173,5959	154,0964	-105,715	211,9263	-27,9761	20,70092	-141,466	
0	49,37396	-67,9574	37,01816	51,40477	132	0	-56,1983	77,83177	95,87532	176,3378	164,1076	-103,117	224,787	-27,5807	34,7437	-151,464	
0	59,39697	-59,397	41,73379	59,29596	132	0	-52,5679	81,54229	111,0022	178,7711	172,2382	-100,224	236,6024	-27,8022	47,14735	-158,745	
0	67,95743	-49,374	49,01707	69,12187	132	0	-45,5187	90,35138	131,35	179,9988	177,7356	-97,8379	246,9114	-29,9688	56,08349	-163,207	
0	74,84455	-38,1352	60,58063	81,010404	132	0	-33,0468	105,9463	158,9214	177,9754	179,3874	-97,0486	254,8348	-36,2588	58,86081	-164,471	
0	79,88875	-25,9574	78,889	94,03841	132	0	-11,4068	129,1719	195,1642	168,5535	175,0655	-99,0422	258,3406	-49,5148	51,68534	-161,089	
0	82,96582	-13,1405	105,5593	104,7134	132	0	23,92523	156,9013	237,3656	145,9387	161,4656	-103,903	253,0117	-72,1693	30,51002	-148,932	
0	0	84	-2,1E-14	136,5	107,9062	132	0	71,26984	179,5493	274,5892	109,856	136,5	-107,906	233,1292	-100,799	-94,9735	-121,347

Slika 4.6. Koordinate točaka

Računanje gornjeg 4-segmentnog mehanizma započinjemo izračunavanjem virtualnih kutova  $\alpha$  i  $\beta$ , ovisno položajima točaka C i E odnosno C i F.

$\alpha 1$	$\beta 1$	$\alpha 2$	$\beta 2$
-0,832217	0,014119	0,073416	0,097476
-1,092478	-0,220536	-0,189991	-0,191538
-1,295347	-0,354361	-0,387732	-0,458322
-1,437022	-0,398435	-0,498548	-0,66674
-1,534457	-0,381484	-0,537899	-0,820478
1,538554	-0,325986	-0,52713	-0,933788
1,488755	-0,246059	-0,482548	-1,018932
1,451579	-0,150254	-0,415052	-1,084417
1,423262	-0,043869	-0,331772	-1,135839
1,401469	0,069665	-0,237463	-1,176856
1,384745	0,187997	-0,135412	-1,209861
1,37221	0,309403	-0,028006	-1,236396
1,363399	0,432497	0,082901	-1,257394
1,358186	0,556035	0,19574	-1,273307
1,356779	0,678753	0,309031	-1,284141
1,35977	0,799198	0,421202	-1,289424
1,368236	0,91554	0,530396	-1,288106
1,383885	1,025358	0,634269	-1,278401
1,409145	1,125503	0,729852	-1,257704
1,446956	1,212297	0,813732	-1,222808
1,499937	1,28243	0,882856	-1,170836
1,56906	1,334402	0,935836	-1,100703
-1,488653	1,369298	0,973647	-1,013909
-1,393069	1,389996	0,998907	-0,913763
-1,289197	1,3997	1,014556	-0,803946
-1,180003	1,401019	1,023023	-0,687604
-1,067831	1,395735	1,026013	-0,567158
-0,95454	1,384901	1,024607	-0,44444
-0,841702	1,368989	1,019393	-0,320902
-0,730795	1,34799	1,010582	-0,197809
-0,623389	1,321456	0,998047	-0,076403
-0,521337	1,288451	0,981323	0,04193
-0,427028	1,247433	0,95953	0,155463
-0,343749	1,196011	0,931213	0,261848
-0,276252	1,130527	0,894037	0,357653
-0,23167	1,045382	0,844238	0,43758
-0,220901	0,932073	0,775657	0,493078
-0,260253	0,778335	0,678222	0,510029
-0,371069	0,569917	0,536546	0,465956
-0,56881	0,303132	0,333678	0,33213
-0,832217	0,014119	0,073416	0,097476

*Slika 4.7. Kut  $\alpha$  i  $\beta$*

Za određivanje koordinata točke G mehanizma za otvorenu i zatvorenu kompoziciju, potrebno je izračunati kutove  $\vartheta_{51}$ ,  $\vartheta_{52}$ ,  $\vartheta_{61}$  i  $\vartheta_{62}$ . Određujemo početni kut gornjeg 4-segmentnog mehanizma koji ovisi o kutovima donjeg 4-segmentnog mehanizma.

$\theta_2'1$ [rad]	$\theta_2'1$ [st]	$\theta_2'2$ [rad]	$\theta_2'2$ [st]
-0,846335	-48,49145	-0,02406	-1,378518
-0,871942	-49,95862	0,001547	0,088655
-0,940986	-53,91452	0,070591	4,044555
-1,038588	-59,50669	0,168193	9,636723
-1,152974	-66,06054	0,282579	16,19057
1,86454	106,8303	0,406658	23,29977
1,734813	99,39748	0,536384	30,73255
1,601833	91,77824	0,669365	38,35179
1,467131	84,06042	0,804066	46,06961
1,331805	76,30679	0,939393	53,82324
1,196748	68,56861	1,07445	61,56143
1,062807	60,89437	1,20839	69,23566
0,930902	53,33677	1,340295	76,79327
0,802151	45,95986	1,469047	84,17018
0,678026	38,84803	1,593171	91,282
0,560571	32,11836	1,710626	98,01168
0,452696	25,93754	1,818502	104,1925
0,358527	20,5421	1,91267	109,5879
0,283642	16,25148	1,987556	113,8786
0,234658	13,44493	2,036539	116,6851
0,217506	12,4622	2,053691	117,6678
0,234658	13,44493	2,036539	116,6851
-2,857951	-163,7485	1,987556	113,8786
-2,783065	-159,4579	1,91267	109,5879
-2,688897	-154,0625	1,818502	104,1925
-2,581022	-147,8816	1,710626	98,01168
-2,463567	-141,152	1,593171	91,282
-2,339442	-134,0401	1,469047	84,17018
-2,21069	-126,6632	1,340295	76,79327
-2,078785	-119,1056	1,20839	69,23566
-1,944845	-111,4314	1,07445	61,56143
-1,809788	-103,6932	0,939393	53,82324
-1,674462	-95,93958	0,804066	46,06961
-1,53976	-88,22176	0,669365	38,35179
-1,406779	-80,60252	0,536384	30,73255
-1,277053	-73,16973	0,406658	23,29977
-1,152974	-66,06054	0,282579	16,19057
-1,038588	-59,50669	0,168193	9,636723
-0,940986	-53,91452	0,070591	4,044555
-0,871942	-49,95862	0,001547	0,088655
-0,846335	-48,49145	-0,02406	-1,378518

*Slika 4.8. Kutovi  $\vartheta'_{21}$  i  $\vartheta'_{22}$*

Potom radimo provjeru dimenzija duljina štapova te uvodimo koordinate G, H, I, J, K i L za zatvorenu i otvorenu kompoziciju te kao i kod donjeg 4-segmentnog mehanizma izračunavamo kutove  $\vartheta_{51}$ ,  $\vartheta_{52}$ ,  $\vartheta_{61}$  i  $\vartheta_{62}$ .

G1	H1	I1	J1	K1	L1
1,223813	-1,497714	-0,301434	-0,301434	1,497714	1,223813
1,265521	-1,53116	-0,298509	-0,298509	1,53116	1,265521
1,382418	-1,616278	-0,29031	-0,29031	1,616278	1,382418
1,557829	-1,723377	-0,278007	-0,278007	1,723377	1,557829
1,776499	-1,827949	-0,26267	-0,26267	1,827949	1,776499
3,272009	1,914333	-0,157777	-0,157777	-1,914333	3,272009
3,000453	1,973159	-0,176823	-0,176823	-1,973159	3,000453
2,715999	1,999037	-0,196775	-0,196775	-1,999037	2,715999
2,426685	1,989263	-0,217067	-0,217067	-1,989263	2,426685
2,140098	1,943154	-0,237167	-0,237167	-1,943154	2,140098
1,86336	1,861712	-0,256577	-0,256577	-1,861712	1,86336
1,603032	1,747449	-0,274836	-0,274836	-1,747449	1,603032
1,364955	1,604318	-0,291535	-0,291535	-1,604318	1,364955
1,15406	1,437706	-0,306326	-0,306326	-1,437706	1,15406
0,974141	1,254514	-0,318946	-0,318946	-1,254514	0,974141
0,827583	1,06334	-0,329225	-0,329225	-1,06334	0,827583
0,71505	0,874782	-0,337118	-0,337118	-0,874782	0,71505
0,635161	0,701791	-0,342721	-0,342721	-0,701791	0,635161
0,58434	0,559707	-0,346286	-0,346286	-0,559707	0,58434
0,557344	0,465021	-0,348179	-0,348179	-0,465021	0,557344
0,549075	0,431591	-0,348759	-0,348759	-0,431591	0,549075
0,557344	0,465021	-0,348179	-0,348179	-0,465021	0,557344
4,71417	-0,559707	-0,056626	-0,056626	0,559707	4,71417
4,66335	-0,701791	-0,060191	-0,060191	0,701791	4,66335
4,58346	-0,874782	-0,065794	-0,065794	0,874782	4,58346
4,470928	-1,06334	-0,073687	-0,073687	1,06334	4,470928
4,32437	-1,254514	-0,083966	-0,083966	1,254514	4,32437
4,14445	-1,437706	-0,096585	-0,096585	1,437706	4,14445
3,933555	-1,604318	-0,111377	-0,111377	1,604318	3,933555
3,695478	-1,747449	-0,128075	-0,128075	1,747449	3,695478
3,43515	-1,861712	-0,146334	-0,146334	1,861712	3,43515
3,158413	-1,943154	-0,165744	-0,165744	1,943154	3,158413
2,871825	-1,989263	-0,185845	-0,185845	1,989263	2,871825
2,582512	-1,999037	-0,206137	-0,206137	1,999037	2,582512
2,298058	-1,973159	-0,226088	-0,226088	1,973159	2,298058
2,026501	-1,914333	-0,245135	-0,245135	1,914333	2,026501
1,776499	-1,827949	-0,26267	-0,26267	1,827949	1,776499
1,557829	-1,723377	-0,278007	-0,278007	1,723377	1,557829
1,382418	-1,616278	-0,29031	-0,29031	1,616278	1,382418
1,265521	-1,53116	-0,298509	-0,298509	1,53116	1,265521
1,223813	-1,497714	-0,301434	-0,301434	1,497714	1,223813

Slika 4.9. Koeficijenti (otvorena konfiguracija)

G2	H2	I2	J2	K2	L2
0,49902	-0,048115	-0,35227	-0,35227	0,048115	0,49902
0,4984	0,003095	-0,352313	-0,352313	-0,003095	0,4984
0,503754	0,141064	-0,351938	-0,351938	-0,141064	0,503754
0,528748	0,334801	-0,350185	-0,350185	-0,334801	0,528748
0,583702	0,557666	-0,34633	-0,34633	-0,557666	0,583702
0,673804	0,791083	-0,340011	-0,340011	-0,791083	0,673804
0,80046	1,022063	-0,331127	-0,331127	-1,022063	0,80046
0,962519	1,240976	-0,319761	-0,319761	-1,240976	0,962519
1,157025	1,440367	-0,306119	-0,306119	-1,440367	1,157025
1,379651	1,6144	-0,290504	-0,290504	-1,6144	1,379651
1,624982	1,758656	-0,273297	-0,273297	-1,758656	1,624982
1,886722	1,870093	-0,254939	-0,254939	-1,870093	1,886722
2,157859	1,947104	-0,235922	-0,235922	-1,947104	2,157859
2,430784	1,989656	-0,216779	-0,216779	-1,989656	2,430784
2,697377	1,999499	-0,198081	-0,198081	-1,999499	2,697377
2,949031	1,980479	-0,18043	-0,18043	-1,980479	2,949031
3,176603	1,938955	-0,164469	-0,164469	-1,938955	3,176603
3,370337	1,884256	-0,15088	-0,15088	-1,884256	3,370337
3,519921	1,828811	-0,140389	-0,140389	-1,828811	3,519921
3,615177	1,786976	-0,133708	-0,133708	-1,786976	3,615177
3,647995	1,771309	-0,131406	-0,131406	-1,771309	3,647995
3,615177	1,786976	-0,133708	-0,133708	-1,786976	3,615177
3,519921	1,828811	-0,140389	-0,140389	-1,828811	3,519921
3,370337	1,884256	-0,15088	-0,15088	-1,884256	3,370337
3,176603	1,938955	-0,164469	-0,164469	-1,938955	3,176603
2,949031	1,980479	-0,18043	-0,18043	-1,980479	2,949031
2,697377	1,999499	-0,198081	-0,198081	-1,999499	2,697377
2,430784	1,989656	-0,216779	-0,216779	-1,989656	2,430784
2,157859	1,947104	-0,235922	-0,235922	-1,947104	2,157859
1,886722	1,870093	-0,254939	-0,254939	-1,870093	1,886722
1,624982	1,758656	-0,273297	-0,273297	-1,758656	1,624982
1,379651	1,6144	-0,290504	-0,290504	-1,6144	1,379651
1,157025	1,440367	-0,306119	-0,306119	-1,440367	1,157025
0,962519	1,240976	-0,319761	-0,319761	-1,240976	0,962519
0,80046	1,022063	-0,331127	-0,331127	-1,022063	0,80046
0,673804	0,791083	-0,340011	-0,340011	-0,791083	0,673804
0,583702	0,557666	-0,34633	-0,34633	-0,557666	0,583702
0,528748	0,334801	-0,350185	-0,350185	-0,334801	0,528748
0,503754	0,141064	-0,351938	-0,351938	-0,141064	0,503754
0,4984	0,003095	-0,352313	-0,352313	-0,003095	0,4984
0,49902	-0,048115	-0,35227	-0,35227	0,048115	0,49902

Slika 4.10. Koeficijenti (zatvorena konfiguracija)

051 [rad]	052 [rad]	053 [rad]	054 [rad]	051 [st]	052 [st]	053 [st]	054 [st]
1,915058	-0,33424	1,55176	-1,243888	109,7247	-19,15055	88,90929	-71,26956
1,667425	-0,558938	1,203044	-1,593395	95,53639	-32,0248	68,92934	-91,29481
1,495927	-0,668176	0,773126	-2,01654	85,71033	-38,28366	44,29686	-115,5392
1,393	-0,682245	0,349095	-2,410474	79,813	-39,08975	20,0017	-138,11
1,334441	-0,635742	-0,010503	-2,710735	76,45784	-36,42533	-0,601761	-155,3136
-0,17975	-1,490378	-0,288186	-2,90462	-10,29894	-85,39237	-16,51182	-166,4225
-0,086587	-1,516998	-0,495596	-3,011442	-4,961052	-86,91757	-28,39554	-172,5429
0,025155	-1,528607	-0,651133	-3,055762	1,441293	-87,58271	-37,30715	-175,0823
0,150553	-1,528412	-0,769922	-3,056863	8,626031	-87,57153	-44,11328	-175,1454
0,286756	-1,517937	-0,862508	-3,028054	16,42989	-86,9714	-49,41807	-173,4947
0,432255	-1,49753	-0,935899	-2,978296	24,76638	-85,80214	-53,62309	-170,6438
0,5865	-1,466571	-0,994691	-2,913717	33,60395	-84,02833	-56,9916	-166,9437
0,749712	-1,423519	-1,041847	-2,838659	42,95536	-81,56161	-59,69344	-162,6432
0,922783	-1,365858	-1,079179	-2,756362	52,87155	-78,25788	-61,83237	-157,9279
1,107089	-1,2901	-1,107602	-2,66941	63,43151	-73,91729	-63,46091	-152,9459
1,303929	-1,192179	-1,127242	-2,580056	74,70966	-68,30681	-64,5862	-147,8263
1,512895	-1,069018	-1,137416	-2,49047	86,68251	-61,25021	-65,16915	-142,6934
1,728253	-0,922504	-1,136548	-2,402942	99,02162	-52,8556	-65,11941	-137,6784
1,933825	-0,765761	-1,122126	-2,31999	110,8	-43,87489	-64,29306	-132,9256
2,101722	-0,625967	-1,090982	-2,244252	120,4198	-35,86529	-62,50864	-128,5862
2,202672	-0,533993	-1,040258	-2,177963	126,2038	-30,59555	-59,60238	-124,7881
2,223827	-0,503863	-0,968877	-2,122147	127,4159	-28,86921	-55,51256	-121,5901
1,733243	1,238925	-0,87833	-2,076194	99,30751	70,98518	-50,32462	-118,9572
1,806879	1,268102	-0,77191	-2,038303	103,5265	72,65687	-44,22718	-116,7862
1,887018	1,284344	-0,653256	-2,00631	108,1182	73,58748	-37,42883	-114,9531
1,97274	1,288984	-0,525421	-1,978235	113,0297	73,85337	-30,10443	-113,3445
2,06229	1,283678	-0,390619	-1,952427	118,1605	73,54932	-22,38085	-111,8658
2,15368	1,269804	-0,250312	-1,927495	123,3968	72,75443	-14,34182	-110,4373
2,244948	1,248214	-0,105355	-1,902167	128,6261	71,51742	-6,036404	-108,9862
2,33416	1,219177	0,043896	-1,87513	133,7375	69,85369	2,515063	-107,437
2,419281	1,182379	0,197559	-1,844838	138,6146	67,74531	11,3193	-105,7014
2,497985	1,136889	0,356278	-1,809268	143,124	65,13893	20,41323	-103,6634
2,567388	1,081046	0,52138	-1,765561	147,1005	61,93939	29,87289	-101,1592
2,623677	1,012233	0,695132	-1,709497	150,3256	57,9967	39,82815	-97,94698
2,661548	0,926487	0,88099	-1,634857	152,4955	53,08378	50,47699	-93,6704
2,673366	0,817894	1,083182	-1,533252	153,1726	46,86185	62,06179	-87,84886
2,647997	0,677814	1,303054	-1,397178	151,7191	38,8359	74,65947	-80,05241
2,569769	0,494525	1,525865	-1,233704	147,2369	28,33419	87,42564	-70,68604
2,420205	0,256102	1,697404	-1,092262	138,6676	14,67356	97,25408	-62,58201
2,191093	-0,03527	1,726712	-1,069727	125,5404	-2,020823	98,93332	-61,29083
1,915058	-0,33424	1,55176	-1,243888	109,7247	-19,15055	88,90929	-71,26956

*Slika 4.11. Kut  $\vartheta_5$  (otvorena i zatvorena konfiguracija)*

$\theta 61$ [rad]	$\theta 62$ [rad]	$\theta 63$ [rad]	$\theta 64$ [rad]	$\theta 61$ [st]	$\theta 62$ [st]	$\theta 63$ [st]	$\theta 64$ [st]
2,807352	-1,226535	1,897704	-1,589833	160,8494	-70,27528	108,7304	-91,09071
2,582654	-1,474168	1,548198	-1,938549	147,9752	-84,46361	88,70519	-111,0707
2,473417	-1,645665	1,125053	-2,368467	141,7163	-94,28967	64,46077	-135,7031
2,459348	-1,748593	0,731119	-2,792497	140,9103	-100,187	41,89002	-159,9983
2,505851	-1,807152	0,430858	-3,152095	143,5747	-103,5422	24,68635	-180,6018
1,651215	-3,321343	0,236973	-3,429778	94,60763	-190,2989	13,57754	-196,5118
1,624595	-3,228179	0,13015	-3,637188	93,08243	-184,9611	7,457063	-208,3955
1,612986	-3,116437	0,08583	-3,792725	92,41729	-178,5587	4,917723	-217,3072
1,613181	-2,99104	0,08473	-3,911515	92,42847	-171,374	4,854645	-224,1133
1,623655	-2,854837	0,113538	-4,004101	93,0286	-163,5701	6,505268	-229,4181
1,644063	-2,709338	0,163296	-4,077492	94,19786	-155,2336	9,356195	-233,6231
1,675022	-2,555093	0,227876	-4,136284	95,97167	-146,396	13,05631	-236,9916
1,718074	-2,39188	0,302933	-4,18344	98,43839	-137,0446	17,3568	-239,6934
1,775735	-2,21881	0,385231	-4,220771	101,7421	-127,1284	22,0721	-241,8324
1,851492	-2,034504	0,472183	-4,249195	106,0827	-116,5685	27,05409	-243,4609
1,949414	-1,837663	0,561537	-4,268835	111,6932	-105,2903	32,1737	-244,5862
2,072575	-1,628698	0,651123	-4,279009	118,7498	-93,31749	37,30657	-245,1691
2,219088	-1,413339	0,738651	-4,278141	127,1444	-80,97838	42,32159	-245,1194
2,375831	-1,207768	0,821603	-4,263718	136,1251	-69,19999	47,07438	-244,2931
2,515625	-1,03987	0,897341	-4,232574	144,1347	-59,58017	51,41385	-242,5086
2,6076	-0,938921	0,96363	-4,18185	149,4045	-53,79621	55,21192	-239,6024
2,63773	-0,917766	1,019446	-4,11047	151,1308	-52,58409	58,40993	-235,5126
4,380518	-1,40835	1,065398	-4,019923	250,9852	-80,69249	61,04282	-230,3246
4,409694	-1,334714	1,103289	-3,913503	252,6569	-76,47347	63,21383	-224,2272
4,425936	-1,254574	1,135283	-3,794849	253,5875	-71,88181	65,0469	-217,4288
4,430577	-1,168853	1,163358	-3,667014	253,8534	-66,97032	66,65548	-210,1044
4,425271	-1,079303	1,189165	-3,532212	253,5493	-61,83951	68,13416	-202,3808
4,411397	-0,987913	1,214097	-3,391905	252,7544	-56,60324	69,56266	-194,3418
4,389807	-0,896644	1,239425	-3,246948	251,5174	-51,37393	71,01384	-186,0364
4,36077	-0,807432	1,266463	-3,097697	249,8537	-46,26247	72,56298	-177,4849
4,323971	-0,722312	1,296755	-2,944034	247,7453	-41,38541	74,29858	-168,6807
4,278482	-0,643608	1,332325	-2,785315	245,1389	-36,87603	76,33657	-159,5868
4,222639	-0,574205	1,376032	-2,620212	241,9394	-32,89951	78,84082	-150,1271
4,153826	-0,517915	1,432095	-2,44646	237,9967	-29,67437	82,05302	-140,1719
4,068079	-0,480044	1,506736	-2,260603	233,0838	-27,50452	86,3296	-129,523
3,959486	-0,468227	1,608341	-2,05841	226,8619	-26,82742	92,15114	-117,9382
3,819407	-0,493595	1,744414	-1,838539	218,8359	-28,28093	99,94759	-105,3405
3,636118	-0,571823	1,907888	-1,615727	208,3342	-32,76306	109,314	-92,57436
3,397695	-0,721387	2,049331	-1,444189	194,6736	-41,33245	117,418	-82,74592
3,106323	-0,9505	2,071866	-1,414881	177,9792	-54,45962	118,7092	-81,06668
2,807352	-1,226535	1,897704	-1,589833	160,8494	-70,27528	108,7304	-91,09071

*Slika 4.12. Kut  $\theta_6$  (otvorena i zatvorena konfiguracija)*

Odredivši kutove gornjeg 4-segmentnog mehanizma možemo odrediti koordinate točke G za zatvorenu i otvorenu konfiguraciju.



Gx1	Gy1	Gx2	Gy2	Gx3	Gy3	Gx4	Gy4
30,76967	292,5083	184,629	140,1831	235,4134	19,17898	166,9932	-214,4441
105,291	309,3592	218,6066	126,2846	243,8483	-11,03452	82,83454	-242,9804
157,6892	311,9438	242,9077	117,9333	254,4746	-46,86641	76,78248	-238,9464
187,688	311,1814	259,6038	117,4087	258,439	-86,29638	264,8128	-207,4665
202,3148	311,3278	270,7713	123,4111	252,2184	-120,0222	108,9508	-168,88
293,4282	175,6099	185,0014	77,45181	240,5229	-142,1426	5,874224	-136,2084
291,5982	189,3038	178,5004	79,85481	228,4072	-153,4322	6,418564	-111,9394
285,582	204,9362	170,6813	82,02464	217,9694	-156,8794	201,9977	-94,43594
275,6315	221,2998	162,0736	83,40941	209,4328	-155,0637	208,2625	-81,68955
261,9302	237,4351	153,1703	83,6617	202,3511	-149,7569	33,0599	-72,21504
244,6494	252,546	144,4707	82,59762	196,1635	-142,1418	190,0504	-65,03446
223,964	265,9453	136,5024	80,18263	190,388	-133,0454	16,40935	-59,52354
200,0491	277,0127	129,8324	76,54036	184,6763	-123,0921	214,3681	-55,29007
173,0771	285,1493	125,0654	71,98632	178,8254	-112,7934	201,5331	-52,09774
143,239	289,7207	122,8099	67,08915	172,7825	-102,5997	53,53676	-49,82386
110,8463	289,9995	123,5574	62,74605	166,6562	-92,92953	-3,082782	-48,44022
76,60758	285,1924	127,3816	60,18607	160,739	-84,18662	80,76932	-48,01
42,12693	274,8096	133,4029	60,64016	155,5417	-76,76119	207,2524	-48,69374
10,25905	259,6873	139,3745	64,33795	151,817	-71,00282	166,7346	-50,7485
-15,65477	243,1037	142,3527	69,31729	150,5146	-67,13411	-22,00911	-54,48501
-33,68588	229,9178	140,487	72,01028	152,5733	-65,09138	168,715	-60,13938
-44,16579	223,3091	133,8327	70,06216	158,5538	-64,37915	19,06344	-67,68725
0,197223	242,4659	58,70273	237,4979	168,3702	-64,11962	201,1642	-76,75656
-18,18819	237,3502	45,65049	235,2232	181,3678	-63,31912	-7,097112	-86,74186
-37,47437	231,4187	33,74914	232,4789	196,6219	-61,13372	67,5931	-96,99907
-57,11649	224,1776	23,20004	229,0077	213,1788	-56,98199	225,7178	-106,9693
-76,47148	215,3983	14,14446	224,6905	230,1611	-50,54007	159,1398	-116,2157
-94,91388	205,1019	6,714277	219,5216	246,7879	-41,69776	24,17706	-124,4196
-111,8922	193,5216	1,057954	213,5836	262,3656	-30,5166	75,15331	-131,369
-126,9469	181,0736	-2,654024	207,0298	276,272	-17,20004	253,8522	-136,9515
-139,7101	168,3439	-4,229663	200,0705	287,9389	-2,076607	223,3388	-141,152
-149,8952	156,0929	-3,452588	192,9622	296,8301	14,40334	64,37089	-144,0553
-157,2738	145,284	-0,070224	185,998	302,4078	31,65073	295,4409	-145,8498
-161,6263	137,1414	6,232221	179,4951	304,0826	48,88231	110,1035	-146,8237
-162,6353	133,25	15,87924	173,7735	301,1535	64,98356	325,3346	-147,3346
-159,6523	135,6989	29,4833	169,1071	292,8247	78,21221	355,7996	-147,7176
-151,1949	147,2068	47,95473	165,6024	278,658	85,72762	239,9314	-148,1928
-133,9566	170,8862	72,57656	162,8999	260,2247	83,62007	254,8097	-149,5053
-101,5137	208,4232	104,6793	159,5693	243,1882	69,52469	374,6147	-156,0353
-45,82795	254,546	143,8506	152,6698	234,3775	46,3751	256,5843	-177,4176
30,76967	292,5083	184,629	140,1831	235,4134	19,17898	166,9932	-214,4441

*Slika 4.13. Koordinate točke G (otvorena i zatvorena konfiguracija)*

## 4.2. Analiza kutnih brzina

Kutne brzine računaju se prema formulama iz se računaju unošanjem formula (2.61), (2.62), (2.63), (2.64), (2.65), (2.66) i (2.67) u ćelije.

$\omega 2$	$\omega 31$	$\omega 32$	$\omega 41$	$\omega 42$	$\omega 21'$	$\omega 22'$	$\omega 51$	$\omega 52$	$\omega 53$	$\omega 54$	$\omega 61$	$\omega 62$	$\omega 63$	$\omega 64$
1	-1,75	-1,75	-1,75	-1,75	-1,75	-1,75	-0,889345	0,673547	3,913018	4,166986	0,673547	-0,889345	4,166986	3,913018
1,145805	-1,720843	-1,743208	-1,3583	-2,105751	-1,3583	-2,105751	-0,426009	0,783731	5,0237	4,68637	0,783731	-0,426009	4,68637	5,0237
1,27202	-1,376431	-1,242626	-0,682313	-1,936743	-0,682313	-1,936743	-0,179035	0,430439	3,945093	2,931278	0,430439	-0,179035	2,931278	3,945093
1,381297	-1,02488	-0,627326	-0,079374	-1,572832	-0,079374	-1,572832	-0,025538	0,047719	1,817915	0,612887	0,047719	-0,025538	0,612887	1,817915
1,474982	-0,75976	-0,10385	0,368004	-1,231614	0,368004	-1,231614	0,159476	-0,196253	0,343922	-0,672551	-0,196253	0,159476	-0,672551	0,343922
1,553774	-0,572701	0,295681	0,687535	-0,964556	0,687535	-0,964556	0,12162	0,511259	-0,262326	-0,994591	0,511259	0,12162	-0,994591	-0,262326
1,618034	-0,439859	0,592155	0,91636	-0,764064	0,91636	-0,764064	0,082193	0,723895	-0,416213	-0,904063	0,723895	0,082193	-0,904063	-0,416213
1,667937	-0,342569	0,810616	1,080832	-0,612784	1,080832	-0,612784	-0,009735	0,872794	-0,405642	-0,713281	0,872794	-0,009735	-0,713281	-0,405642
1,703559	-0,268442	0,970001	1,197543	-0,495984	1,197543	-0,495984	-0,141544	0,941343	-0,349791	-0,530879	0,941343	-0,141544	-0,530879	-0,349791
1,724928	-0,209424	1,083173	1,276692	-0,402943	1,276692	-0,402943	-0,304896	0,916568	-0,288751	-0,382348	0,916568	-0,304896	-0,382348	-0,288751
1,732051	-0,160117	1,158593	1,324524	-0,326047	1,324524	-0,326047	-0,49408	0,79064	-0,233518	-0,267423	0,79064	-0,49408	-0,267423	-0,233518
1,724928	-0,116679	1,201727	1,344794	-0,259746	1,344794	-0,259746	-0,704329	0,561939	-0,18536	-0,179982	0,561939	-0,704329	-0,179982	-0,18536
1,703559	-0,076119	1,215971	1,339592	-0,19974	1,339592	-0,19974	-0,929864	0,236549	-0,142491	-0,113938	0,236549	-0,929864	-0,113938	-0,142491
1,667937	-0,035826	1,203203	1,309768	-0,14239	1,309768	-0,14239	-1,160978	-0,168957	-0,102181	-0,064651	-0,168957	-1,160978	-0,064651	-0,102181
1,618034	0,006771	1,164085	1,255129	-0,084274	1,255129	-0,084274	-1,379218	-0,622256	-0,061278	-0,029034	-0,622256	-1,379218	-0,029034	-0,061278
1,553774	0,054415	1,098233	1,174543	-0,021894	1,174543	-0,021894	-1,550389	-1,06686	-0,016242	-0,005324	-1,06686	-1,550389	-0,005324	-0,016242
1,474982	0,109992	1,004492	1,066162	0,048322	1,066162	0,048322	-1,619471	-1,414616	0,036752	0,007377	-1,414616	-1,619471	0,007377	0,036752
1,381297	0,175802	0,881769	0,928309	0,129262	0,928309	0,129262	-1,523851	-1,558106	0,100899	0,010091	-1,558106	-1,523851	0,010091	0,100899
1,27202	0,251292	0,731324	0,761986	0,22063	0,761986	0,22063	-1,247193	-1,433777	0,175826	0,006103	-1,433777	-1,247193	0,006103	0,175826
1,145805	0,328629	0,561054	0,575624	0,314059	0,575624	0,314059	-0,876241	-1,105261	0,251969	0,003904	-1,105261	-0,876241	0,003904	0,251969
1	0,388889	0,388889	0,388889	0,388889	0,388889	0,388889	-0,544167	-0,729587	0,306725	0,016475	-0,729587	-0,544167	0,016475	0,306725
0,828934	0,405895	0,237747	0,227206	0,416436	0,227206	0,416436	-0,307067	-0,416793	0,312876	0,049936	-0,416793	-0,307067	0,049936	0,312876
0,618034	0,355327	0,122095	0,107197	0,370225	0,107197	0,370225	-0,148954	0,181097	0,255799	0,087382	0,181097	-0,148954	0,087382	0,255799
0,303346	0,193645	0,038608	0,028387	0,203866	0,028387	0,203866	-0,035257	0,044337	0,124893	0,076135	0,044337	-0,035257	0,076135	0,124893
#NUM!	#NUM!	#NUM!	#NUM!	#NUM!	#NUM!	#NUM!	#NUM!	#NUM!	#NUM!	#NUM!	#NUM!	#NUM!	#NUM!	#NUM!
#NUM!	#NUM!	#NUM!	#NUM!	#NUM!	#NUM!	#NUM!	#NUM!	#NUM!	#NUM!	#NUM!	#NUM!	#NUM!	#NUM!	#NUM!
#NUM!	#NUM!	#NUM!	#NUM!	#NUM!	#NUM!	#NUM!	#NUM!	#NUM!	#NUM!	#NUM!	#NUM!	#NUM!	#NUM!	#NUM!
#NUM!	#NUM!	#NUM!	#NUM!	#NUM!	#NUM!	#NUM!	#NUM!	#NUM!	#NUM!	#NUM!	#NUM!	#NUM!	#NUM!	#NUM!
#NUM!	#NUM!	#NUM!	#NUM!	#NUM!	#NUM!	#NUM!	#NUM!	#NUM!	#NUM!	#NUM!	#NUM!	#NUM!	#NUM!	#NUM!
#NUM!	#NUM!	#NUM!	#NUM!	#NUM!	#NUM!	#NUM!	#NUM!	#NUM!	#NUM!	#NUM!	#NUM!	#NUM!	#NUM!	#NUM!
#NUM!	#NUM!	#NUM!	#NUM!	#NUM!	#NUM!	#NUM!	#NUM!	#NUM!	#NUM!	#NUM!	#NUM!	#NUM!	#NUM!	#NUM!
#NUM!	#NUM!	#NUM!	#NUM!	#NUM!	#NUM!	#NUM!	#NUM!	#NUM!	#NUM!	#NUM!	#NUM!	#NUM!	#NUM!	#NUM!
#NUM!	#NUM!	#NUM!	#NUM!	#NUM!	#NUM!	#NUM!	#NUM!	#NUM!	#NUM!	#NUM!	#NUM!	#NUM!	#NUM!	#NUM!
#NUM!	#NUM!	#NUM!	#NUM!	#NUM!	#NUM!	#NUM!	#NUM!	#NUM!	#NUM!	#NUM!	#NUM!	#NUM!	#NUM!	#NUM!
#NUM!	#NUM!	#NUM!	#NUM!	#NUM!	#NUM!	#NUM!	#NUM!	#NUM!	#NUM!	#NUM!	#NUM!	#NUM!	#NUM!	#NUM!
#NUM!	#NUM!	#NUM!	#NUM!	#NUM!	#NUM!	#NUM!	#NUM!	#NUM!	#NUM!	#NUM!	#NUM!	#NUM!	#NUM!	#NUM!
0,303346	-0,137767	-0,225074	-0,345409	-0,017431	-0,345409	-0,017431	-0,318344	-0,143356	0,037216	0,036899	-0,143356	-0,318344	0,036899	0,037216
0,618034	-0,603752	-0,668764	-0,941002	-0,331514	-0,941002	-0,331514	-0,853148	-0,199626	0,712795	0,775299	-0,199626	-0,853148	0,775299	0,712795
0,828934	-1,261125	-1,244945	-1,523407	-0,982664	-1,523407	-0,982664	-1,152	0,121771	2,058494	2,317144	0,121771	-1,152	2,317144	2,058494
1	-1,75	-1,75	-1,75	-1,75	-1,75	-1,75	-0,889345	0,673547	3,913018	4,166986	0,673547	-0,889345	4,166986	3,913018

Slika 4.14. Kutne brzine Wattovog I. tipa mehanizma



### 4.3. Analiza kutnih ubrzanja

Kutna ubrzanja se računaju unošenjem formula (2.73), (2.74), (2.75), (2.76), (2.77), (2.78) i (2.79) u Python kao što je i prikazano na slici 4.18.

ε31	ε32	ε41	ε42	ε21'	ε22'	ε51	ε52	ε53	ε54	ε61	ε62	ε63	ε64
-1,549305	-1,950695	0,591443	-4,091443	0,591443	-4,091443	-2,205652	-2,684059	-13,47015	-5,43576	-2,684059	-2,205652	-5,43576	-13,47015
1,712603	2,149676	4,486308	-0,399134	4,486308	-0,399134	-2,109582	-2,36904	3,151649	15,10338	-2,36904	-2,109582	15,10338	3,151649
2,69165	4,556932	5,416052	2,532115	5,416052	2,532115	-0,376072	-1,062527	19,75744	26,94385	-1,062527	-0,376072	26,94385	19,75744
2,133584	4,482728	4,603106	3,136369	4,603106	3,136369	0,314056	-0,606108	10,59351	12,81064	-0,606108	0,314056	12,81064	10,59351
1,334404	3,55928	3,584366	2,705808	3,584366	2,705808	0,299122	-0,616124	1,747893	2,61042	-0,616124	0,299122	2,61042	1,747893
0,694959	2,66274	2,788511	2,102553	2,788511	2,102553	0,288475	0,648397	-0,105539	0,612149	0,648397	0,288475	0,612149	-0,105539
0,244244	1,999921	2,223443	1,588248	2,223443	1,588248	0,240092	0,701036	0,128285	0,760887	0,701036	0,240092	0,760887	0,128285
-0,061959	1,558992	1,82404	1,200367	1,82404	1,200367	0,172413	0,815046	0,462715	0,959985	0,815046	0,172413	0,959985	0,462715
-0,265512	1,285659	1,533627	0,920542	1,533627	0,920542	0,144977	1,002905	0,636184	0,986443	1,002905	0,144977	0,986443	0,636184
-0,395212	1,128775	1,312803	0,724299	1,312803	0,724299	0,215393	1,292286	0,703806	0,914405	1,292286	0,215393	0,914405	0,703806
-0,46865	1,047512	1,135024	0,59245	1,135024	0,59245	0,415	1,715035	0,72279	0,803938	1,715035	0,415	0,803938	0,72279
-0,495561	1,009634	0,981732	0,512286	0,981732	0,512286	0,728359	2,277225	0,72389	0,68346	2,277225	0,728359	0,68346	0,72389
-0,479841	0,988574	0,838857	0,476644	0,838857	0,476644	1,073811	2,91718	0,721539	0,564311	2,91718	1,073811	0,564311	0,721539
-0,42077	0,960993	0,694542	0,482858	0,694542	0,482858	1,286837	3,461089	0,722229	0,450444	3,461089	1,286837	0,450444	0,722229
-0,31375	0,905171	0,537903	0,53175	0,537903	0,53175	1,121068	3,598682	0,728751	0,3431	3,598682	1,121068	0,3431	0,728751
-0,151498	0,800729	0,35923	0,625959	0,35923	0,625959	0,314801	2,939091	0,741938	0,243067	2,939091	0,314801	0,243067	0,741938
0,072368	0,631337	0,153219	0,765758	0,153219	0,765758	-1,186789	1,263782	0,760965	0,152159	1,263782	-1,186789	0,152159	0,760965
0,353785	0,393754	-0,071786	0,939185	-0,071786	0,939185	-2,868895	-0,999541	0,782736	0,07469	-0,999541	-2,868895	0,07469	0,782736
0,660444	0,115366	-0,277909	1,105751	-0,277909	1,105751	-3,701556	-2,676104	0,801416	0,018691	-2,676104	-3,701556	0,018691	0,801416
0,919482	-0,133558	-0,392612	1,191031	-0,392612	1,191031	-3,245481	-2,986179	0,810563	-0,005223	-2,986179	-3,245481	-0,005223	0,810563
1,051935	-0,274157	-0,356766	1,134544	-0,356766	1,134544	-2,286061	-2,491117	0,807134	0,011763	-2,491117	-2,286061	0,011763	0,807134
1,048648	-0,294272	-0,205813	0,970795	-0,205813	0,970795	-1,645408	-2,037543	0,785713	0,076348	-2,037543	-1,645408	0,076348	0,785713
0,967524	-0,243606	-0,046638	0,806055	-0,046638	0,806055	-1,488538	1,794635	0,728921	0,194924	1,794635	-1,488538	0,194924	0,728921
0,826748	-0,114112	0,052798	0,70793	0,052798	0,70793	-1,247122	1,567423	0,625914	0,360064	1,567423	-1,247122	0,360064	0,625914
#NUM!	#NUM!	#NUM!	#NUM!	#NUM!	#NUM!	#NUM!	#NUM!	#NUM!	#NUM!	#NUM!	#NUM!	#NUM!	#NUM!
#NUM!	#NUM!	#NUM!	#NUM!	#NUM!	#NUM!	#NUM!	#NUM!	#NUM!	#NUM!	#NUM!	#NUM!	#NUM!	#NUM!
#NUM!	#NUM!	#NUM!	#NUM!	#NUM!	#NUM!	#NUM!	#NUM!	#NUM!	#NUM!	#NUM!	#NUM!	#NUM!	#NUM!
#NUM!	#NUM!	#NUM!	#NUM!	#NUM!	#NUM!	#NUM!	#NUM!	#NUM!	#NUM!	#NUM!	#NUM!	#NUM!	#NUM!
#NUM!	#NUM!	#NUM!	#NUM!	#NUM!	#NUM!	#NUM!	#NUM!	#NUM!	#NUM!	#NUM!	#NUM!	#NUM!	#NUM!
#NUM!	#NUM!	#NUM!	#NUM!	#NUM!	#NUM!	#NUM!	#NUM!	#NUM!	#NUM!	#NUM!	#NUM!	#NUM!	#NUM!
#NUM!	#NUM!	#NUM!	#NUM!	#NUM!	#NUM!	#NUM!	#NUM!	#NUM!	#NUM!	#NUM!	#NUM!	#NUM!	#NUM!
#NUM!	#NUM!	#NUM!	#NUM!	#NUM!	#NUM!	#NUM!	#NUM!	#NUM!	#NUM!	#NUM!	#NUM!	#NUM!	#NUM!
#NUM!	#NUM!	#NUM!	#NUM!	#NUM!	#NUM!	#NUM!	#NUM!	#NUM!	#NUM!	#NUM!	#NUM!	#NUM!	#NUM!
#NUM!	#NUM!	#NUM!	#NUM!	#NUM!	#NUM!	#NUM!	#NUM!	#NUM!	#NUM!	#NUM!	#NUM!	#NUM!	#NUM!
#NUM!	#NUM!	#NUM!	#NUM!	#NUM!	#NUM!	#NUM!	#NUM!	#NUM!	#NUM!	#NUM!	#NUM!	#NUM!	#NUM!
#NUM!	#NUM!	#NUM!	#NUM!	#NUM!	#NUM!	#NUM!	#NUM!	#NUM!	#NUM!	#NUM!	#NUM!	#NUM!	#NUM!
#NUM!	#NUM!	#NUM!	#NUM!	#NUM!	#NUM!	#NUM!	#NUM!	#NUM!	#NUM!	#NUM!	#NUM!	#NUM!	#NUM!
-0,963777	-1,113958	-1,344842	-0,282235	-1,344842	-0,282235	0,949973	0,421183	-2,135325	-2,116361	0,421183	0,949973	-2,116361	-2,135325
-2,62149	-2,277142	-2,479755	-1,941585	-2,479755	-1,941585	1,034598	0,221543	-2,612409	-2,516024	0,221543	1,034598	-2,516024	-2,612409
-3,59202	-3,343578	-2,590758	-4,15395	-2,590758	-4,15395	0,17444	-0,773746	-7,282268	-5,121459	-0,773746	0,17444	-5,121459	-7,282268
-1,549305	-1,950695	0,591443	-4,091443	0,591443	-4,091443	-2,205652	-2,684059	-13,47015	-5,43576	-2,684059	-2,205652	-5,43576	-13,47015

Slika 4.15. Kutna ubrzanja Wattovog I. tipa mehanizma

## 4.4. Analiza sila

Za određivanje inercijskih momenata i inercijskih sila potrebna je odrediti ubrzanja točaka zglobova (slika 4.22. i 4.23.) za koje je potrebno znati udaljenosti od težišta (slika 4.21.) i masu svakog pojedinog elementa mehanizma .

g2	xT31	yT31	xT32	yT32	g31	g32	xT41	yT41	xT42	yT42	g41	g42	g5	g6
42	97,25661	95,8185	151,2097	-69,5685	96,73118	96,73118	181,0297	72,58739	89,18422	-76,4176	87,59476	87,59476	60	60
42	120,4333	102,3207	129,7437	-71,528	96,73118	96,73118	196,5631	59,19837	69,18042	-61,0454	87,59476	87,59476	60	60
42	134,5559	105,7599	109,1216	-66,2508	96,73118	96,73118	203,8844	50,05466	55,30929	-42,3247	87,59476	87,59476	60	60
42	140,2322	109,419	93,70076	-56,7403	96,73118	96,73118	206,02	46,83886	48,21141	-25,5405	87,59476	87,59476	60	60
42	139,9695	113,9587	83,06652	-46,1699	96,73118	96,73118	205,2155	48,0868	45,28856	-12,4084	87,59476	87,59476	60	60
42	135,6656	118,8951	75,53409	-35,9787	96,73118	96,73118	202,4354	52,07398	44,44163	-2,52464	87,59476	87,59476	60	60
42	128,5098	123,5852	69,74569	-26,6043	96,73118	96,73118	198,0528	57,53144	44,54412	4,93061	87,59476	87,59476	60	60
42	119,2839	127,4926	64,83827	-18,1279	96,73118	96,73118	192,2465	63,58613	45,05421	10,64295	87,59476	87,59476	60	60
42	108,5642	130,2181	60,30169	-10,5402	96,73118	96,73118	185,1541	69,62387	45,71618	15,09784	87,59476	87,59476	60	60
42	96,82435	131,4832	55,84775	-3,82711	96,73118	96,73118	176,9242	75,19745	46,40786	18,6233	87,59476	87,59476	60	60
42	84,48352	131,1111	51,32707	2,009428	96,73118	96,73118	167,7325	79,97519	47,06902	21,43761	87,59476	87,59476	60	60
42	71,92691	129,0143	46,68017	6,94997	96,73118	96,73118	157,7839	83,71401	47,66769	23,6834	87,59476	87,59476	60	60
42	59,51243	125,1858	41,90912	10,96086	96,73118	96,73118	147,3101	86,2464	48,18355	25,44888	87,59476	87,59476	60	60
42	47,56964	119,6954	37,06098	13,99673	96,73118	96,73118	136,5658	87,47569	48,59911	26,77935	87,59476	87,59476	60	60
42	36,39389	112,6877	32,21893	16,00051	96,73118	96,73118	125,8236	87,37674	48,89412	27,68132	87,59476	87,59476	60	60
42	26,23672	104,3836	27,499	16,89977	96,73118	96,73118	115,3696	86,00158	49,04154	28,12004	87,59476	87,59476	60	60
42	17,29234	95,08391	23,05225	16,59958	96,73118	96,73118	105,499	83,48975	49,00453	28,01061	87,59476	87,59476	60	60
42	9,679475	85,17361	19,07283	14,97387	96,73118	96,73118	96,50841	80,08239	48,73662	27,2039	87,59476	87,59476	60	60
42	3,420257	75,11566	15,8104	11,86508	96,73118	96,73118	88,67975	76,13277	48,19144	25,47484	87,59476	87,59476	60	60
42	-1,57464	65,41283	13,57754	7,11549	96,73118	96,73118	82,24322	72,09095	47,35367	22,53532	87,59476	87,59476	60	60
42	-5,49116	56,50914	12,72895	0,657523	96,73118	96,73118	77,31375	68,42701	46,29728	18,10764	87,59476	87,59476	60	60
42	-8,54749	48,65621	13,59258	-7,36152	96,73118	96,73118	73,8329	65,49375	45,23907	12,05749	87,59476	87,59476	60	60
42	-10,9095	41,85688	16,38218	-16,5325	96,73118	96,73118	71,58329	63,42447	44,52045	4,491194	87,59476	87,59476	60	60
42	-12,6522	35,95279	21,15763	-26,2817	96,73118	96,73118	70,28359	62,16049	44,50973	-4,27735	87,59476	87,59476	60	60
42	-13,7821	30,76316	27,8475	-36,0196	96,73118	96,73118	69,68329	61,55867	45,50555	-13,8402	87,59476	87,59476	60	60
42	-14,2775	26,16677	36,29147	-45,232	96,73118	96,73118	69,60215	61,47643	47,69682	-23,7869	87,59476	87,59476	60	60
42	-14,1157	22,11908	46,27168	-53,5064	96,73118	96,73118	69,92785	61,80526	51,16569	-33,744	87,59476	87,59476	60	60
42	-13,286	18,64042	57,53068	-60,5281	96,73118	96,73118	70,60108	62,47411	55,90421	-43,3852	87,59476	87,59476	60	60
42	-11,7926	15,7997	69,78179	-66,0712	96,73118	96,73118	71,60294	63,44318	61,83025	-52,4314	87,59476	87,59476	60	60
42	-9,65344	13,70249	82,71676	-69,9924	96,73118	96,73118	72,94835	64,69733	68,79886	-60,6503	87,59476	87,59476	60	60
42	-6,89586	12,48507	96,01234	-72,2291	96,73118	96,73118	74,68565	66,24129	76,60928	-67,858	87,59476	87,59476	60	60
42	-3,54888	12,31475	109,3363	-72,8022	96,73118	96,73118	76,90276	68,09652	85,00773	-73,9227	87,59476	87,59476	60	60
42	0,369726	13,39679	122,3518	-71,8238	96,73118	96,73118	79,74147	70,29857	93,68496	-78,7706	87,59476	87,59476	60	60
42	4,876395	15,98922	134,7193	-69,512	96,73118	96,73118	83,42384	72,8917	102,2658	-82,3937	87,59476	87,59476	60	60
42	10,06459	20,42637	146,0895	-66,2184	96,73118	96,73118	88,29783	75,91418	110,2838	-84,8602	87,59476	87,59476	60	60
42	16,18763	27,14709	156,0792	-62,4745	96,73118	96,73118	94,91201	79,35568	117,1285	-86,3231	87,59476	87,59476	60	60
42	23,8186	36,69976	164,2015	-59,0696	96,73118	96,73118	104,1224	83,04023	121,9397	-87,0151	87,59476	87,59476	60	60
42	34,12614	49,60836	169,6889	-57,1475	96,73118	96,73118	117,1674	86,3298	123,4161	-87,1732	87,59476	87,59476	60	60
42	49,12364	65,75097	171,0983	-58,1715	96,73118	96,73118	135,3511	87,53064	119,5836	-86,7103	87,59476	87,59476	60	60
42	70,81679	82,82472	165,8144	-63,0708	96,73118	96,73118	158,3083	83,55068	108,1252	-84,2783	87,59476	87,59476	60	60
42	97,25661	95,8185	151,2097	-69,5685	96,73118	96,73118	181,0297	72,58739	89,18422	-76,4176	87,59476	87,59476	60	60

Slika 4.16. Težišta elemenata



Uvrštavanjem ubrzanja točaka težišta u matricu dobijemo matricu koju onda prebacimo u njen inverzni oblik kako bi dobili Matricu A.

-1	0	42	0	0	0	0	0	0	0	0	0	0	0	0	0	0	0	0	0
0	-1	-42	0	0	0	0	0	0	0	0	0	0	0	0	0	0	0	0	0
1	0	0	-1	0	95,8185	0	0	0	0	0	0	0	0	0	0	0	0	0	0
0	1	42	0	-1	-95,8185	0	0	0	0	0	0	0	0	0	0	0	0	0	0
0	0	0	1	0	-12,0877	-1	0	-35,3188	0	0	0	0	0	0	0	0	0	0	0
0	0	0	0	1	39,24339	0	-1	-73,1235	0	0	0	0	0	0	0	0	0	0	0
0	0	0	0	0	0	1	0	72,58739	0	0	0	0	0	0	0	0	0	0	0
0	0	0	0	0	0	0	-1	-49,0297	0	0	0	0	0	0	0	0	0	0	0
0	0	0	1	0	83,73078	0	0	0	1	0	56,4795	0	0	0	0	0	0	0	0
0	0	0	0	1	-25,9868	0	0	0	0	1	20,25009	0	0	0	0	0	0	0	0
0	0	0	0	0	0	0	0	0	0	-1	0	-56,4795	-1	0	-162,969	0	0	0	0
0	0	0	0	0	0	0	0	0	0	-1	-20,2501	0	0	-1	-187,14	0	0	0	0
0	0	0	0	0	0	1	0	37,26857	0	0	0	1	0	0	-19,6831	0	0	0	0
0	0	0	0	0	0	0	1	93,55944	0	0	0	0	0	0	1	-56,6796	0	0	0
0	0	1	0	0	0	0	0	0	0	0	0	0	0	0	0	0	0	0	0

*Slika 4.19. Matrica A*

Umnožak mase i akceleracija pojedinih elemenata mehanizma te inercijski momenti daju nam vektor B.

m2	m3	m4	m5	m6
0,1	0,2	0,1	0,1	0,15

*Slika 4.20. Mase pojedinih elemenata mehanizma*

I2	I3	I4	I5	I6
235,2	2400	972	480	720

*Slika 4.21. Inercijski momenti*

-4,2
4,2
235,2
-82,2363
5,54005
-3718,33
0,902216
-27,3067
574,8827
-55,2238
-2,0771
-1058,71
14,56259
-62,6892
-1932,52

*Slika 4.22. Vektor B*

Umnoškom Matrice A i Vektora B dobijemo rješenje odnosno vrijednosti nepoznatih sila za svaki kut pogonskog člana  $\vartheta_2$ .

9882,6
-9882,6
-356207
366162
24558,81
-187925
41730,14
-28159
-371272
75191,86
374778
383155,9
59478,54
163230,3
235,2

*Slika 4.23. Rješenje, matrice sila otvorene konfiguracije*

Ukupno se dobivaju 4 rješenja, 2 za otvorenu konfiguraciju i 2 za zatvorenu konfiguraciju.

## 5. PRIKAZ GIBANJA WATT I. MEHANIZMA U EXCELLU

Za prikaz gibanja Wattovog mehanizma koristimo se funkcijom crtanja grafova u Excelu. Kao rješenje ove analize imati ćemo 4 grafa koji će se gibati po koordinatama ovisno o vrijednostima kutova

### 5.1 Oslonci i segmenti mehanizma

Određimo koordinate fiksnih oslonaca koji će se prikazivati na sva 4 grafa.

Oslonac 1.			Oslonac 2.		
	x	y		x	y
O1s	0	0	O3s	132	0
O1l	-10	-10	O3l	122	-10
O1d	10	-10	O3d	142	-10
O1s	0	0	O3s	132	0

*Slika 5.1. Koordinate oslonaca Watt I. mehanizma*

Također postavimo koordinate krajnjih točaka svakog segmenta za svaku konfiguraciju gdje će se ovisno o promjeni pogonskog kuta mijenjati i vrijednosti i kordinata točaka.

Štap R2		
	x	y
A	0	0
B	84	0
Ploča R3		
	x	y
B	84	0
C	136,5	107,9062
E	71,26984	179,5493
B	84	0
Ploča R4		
	x	y
C	136,5	107,9062
D	132	0
F	274,5892	109,856
C	136,5	107,9062
Štap R5		
	x	y
E	71,26984	179,5493
G	30,76967	292,5083
Štap R6		
	x	y
F	274,5892	109,856
G	30,76967	292,5083

*Slika 5.2. Koordinate segmenata mehanizma*



## 5.2 Prikaz gibanja mehanizma (otvoreno-otvorena konfiguracija)

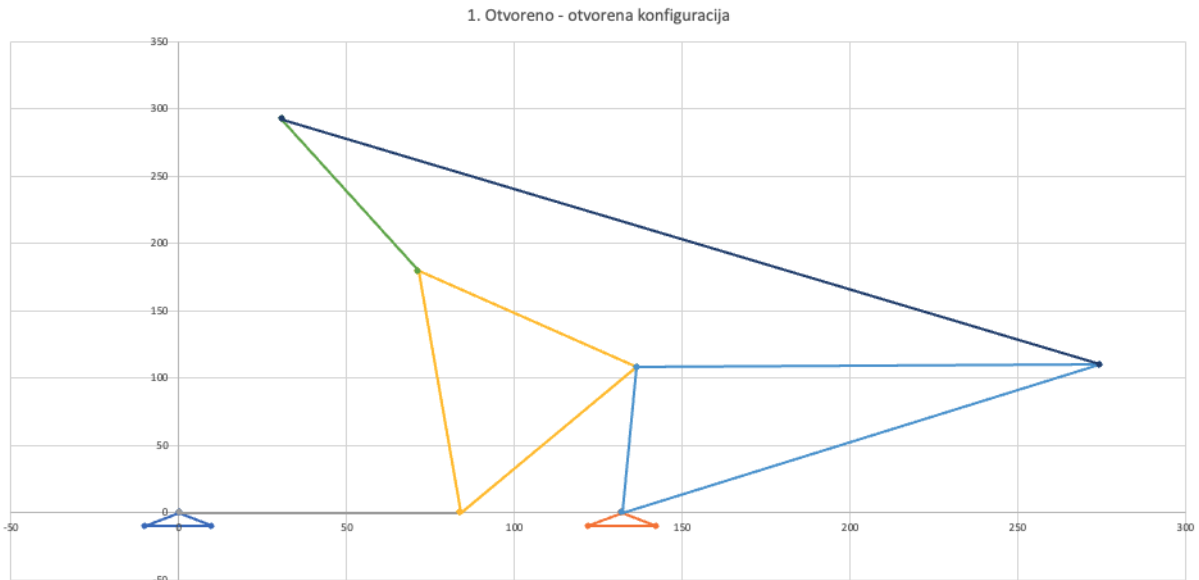

*Slika 5.3. Otvoreno - otvorena konfiguracija ( $\theta_2 = 0^\circ$ )*

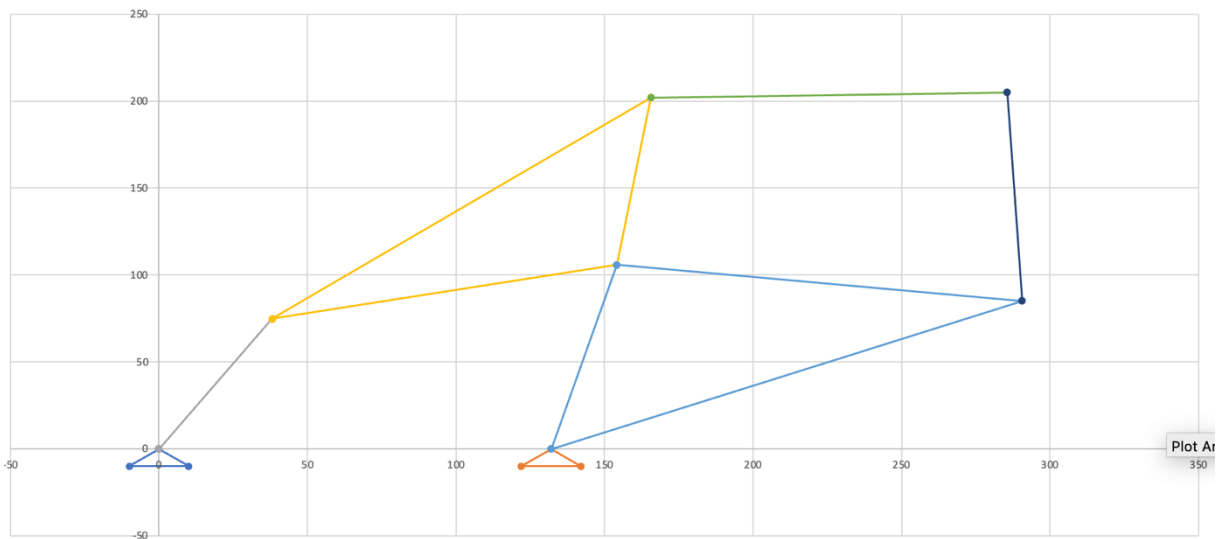

*Slika 5.4. Otvoreno - otvorena konfiguracija ( $\theta_2 = 63^\circ$ )*

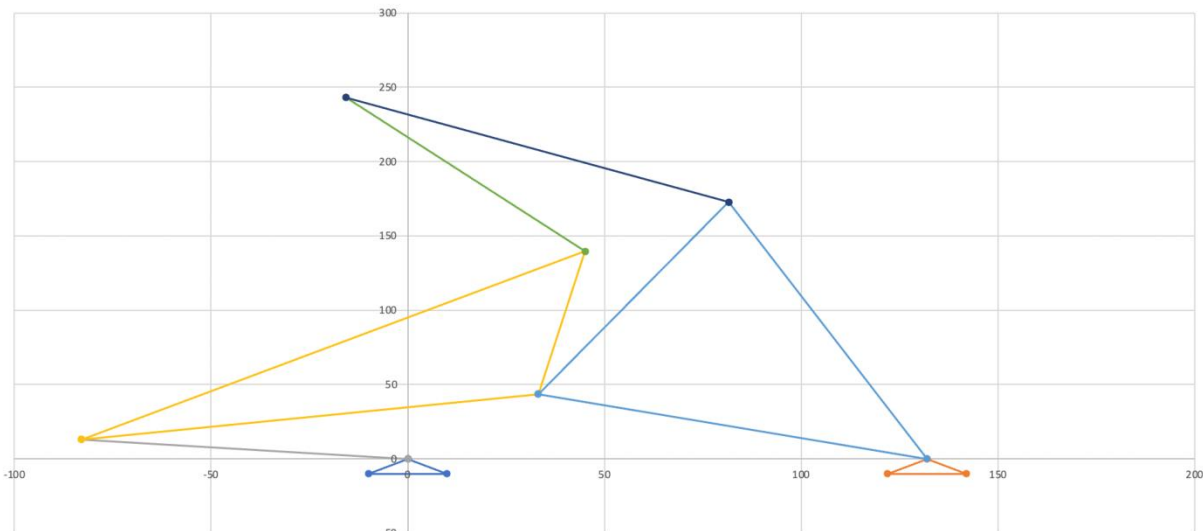

*Slika 5.5. Otvoreno - otvorena konfiguracija ( $\theta_2 = 171^\circ$ )*

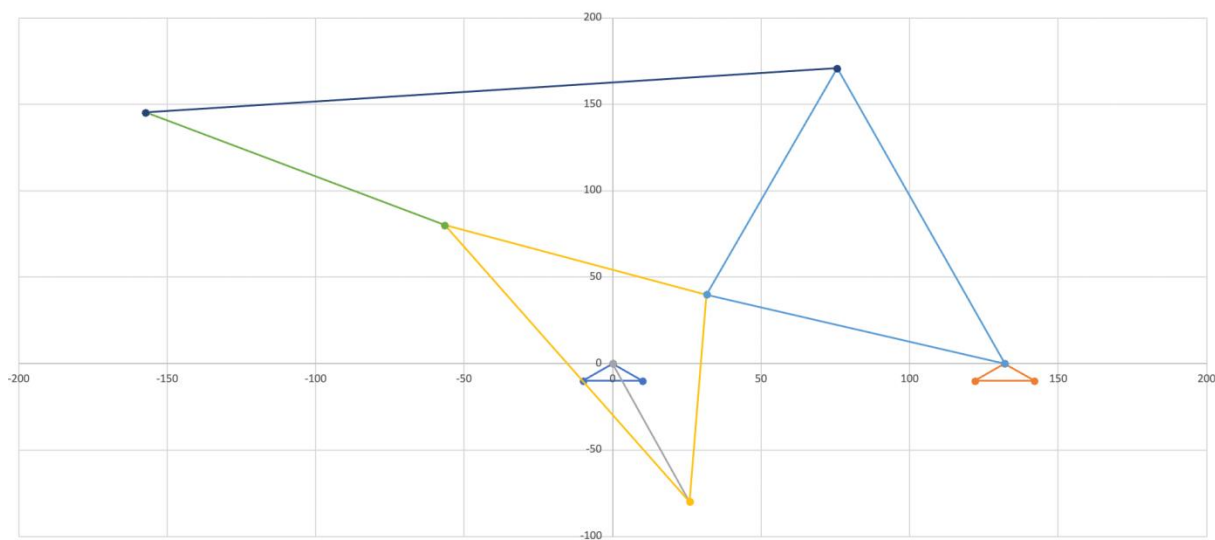

*Slika 5.6. Otvoreno - otvorena konfiguracija ( $\theta_2 = 288^\circ$ )*



### 5.3 Prikaz gibanja mehanizma (otvoreno-zatvorena konfiguracija)

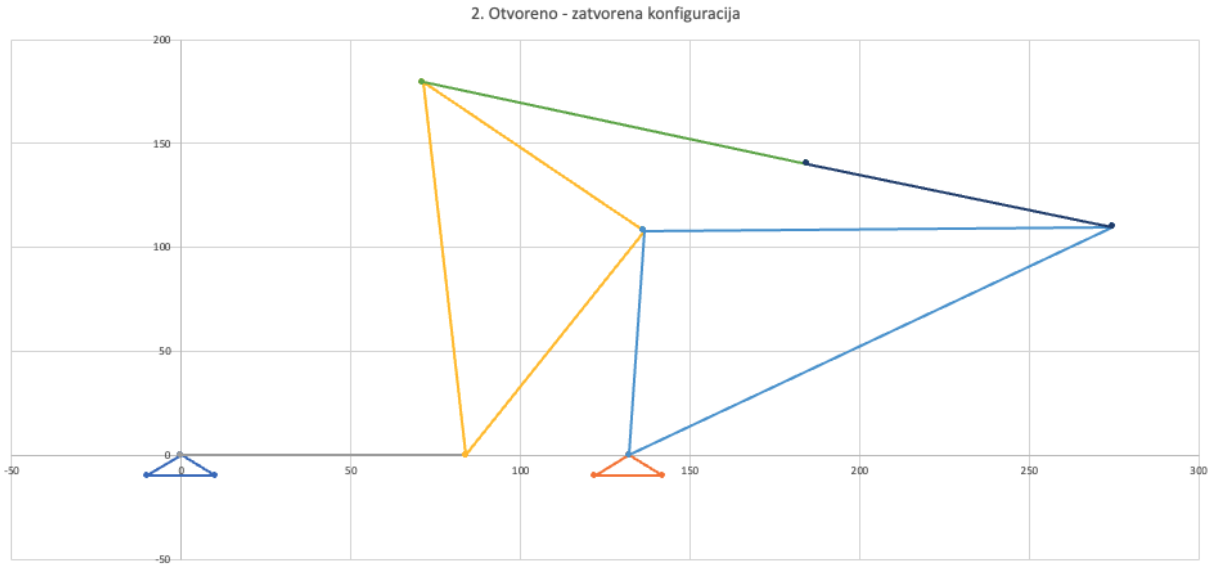

*Slika 5.7. Otvoreno - zatvorena konfiguracija ( $\theta_2 = 0^\circ$ )*

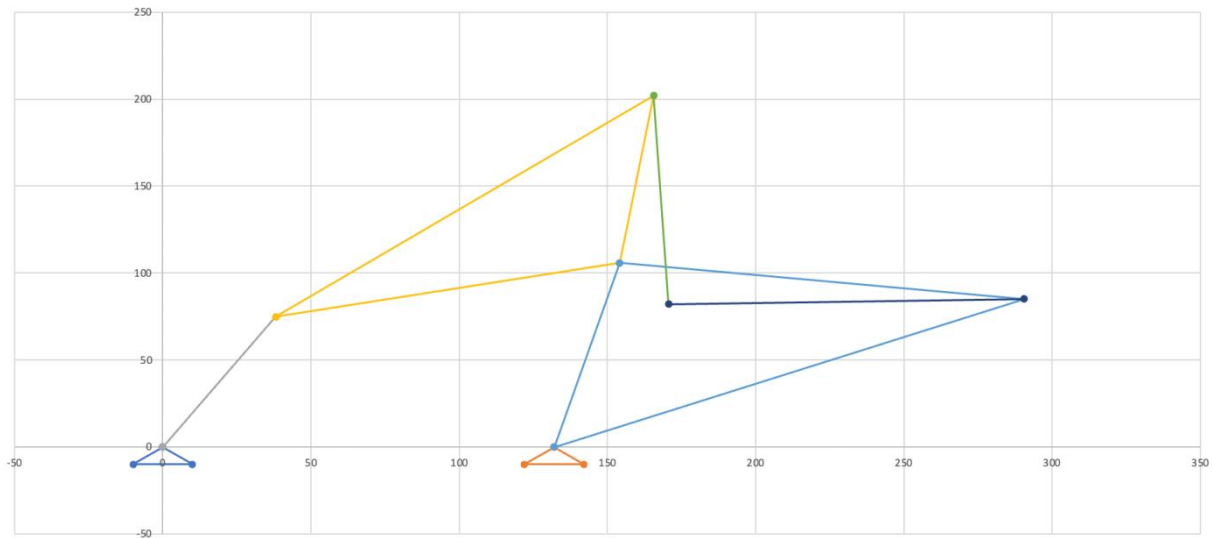

*Slika 5.8. Otvoreno - zatvorena konfiguracija ( $\theta_2 = 63^\circ$ )*

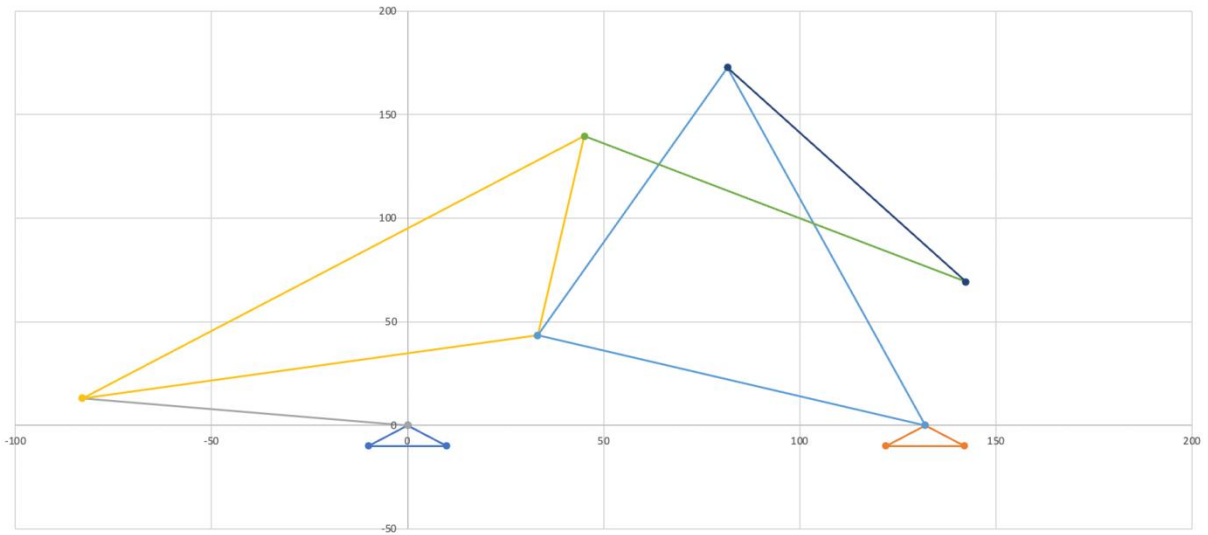

*Slika 5.9. Otvoreno - zatvorena konfiguracija ( $\theta_2 = 171^\circ$ )*

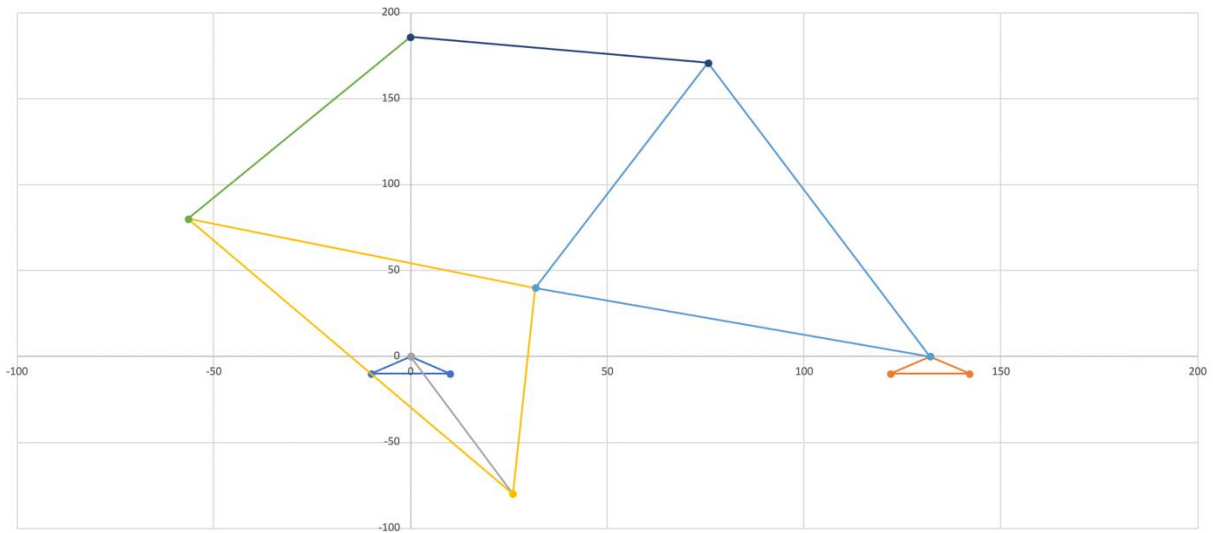

*Slika 5.10. Otvoreno - zatvorena konfiguracija ( $\theta_2 = 288^\circ$ )*

## 5.4 Prikaz gibanja mehanizma (zatvoreno-otvorena konfiguracija)

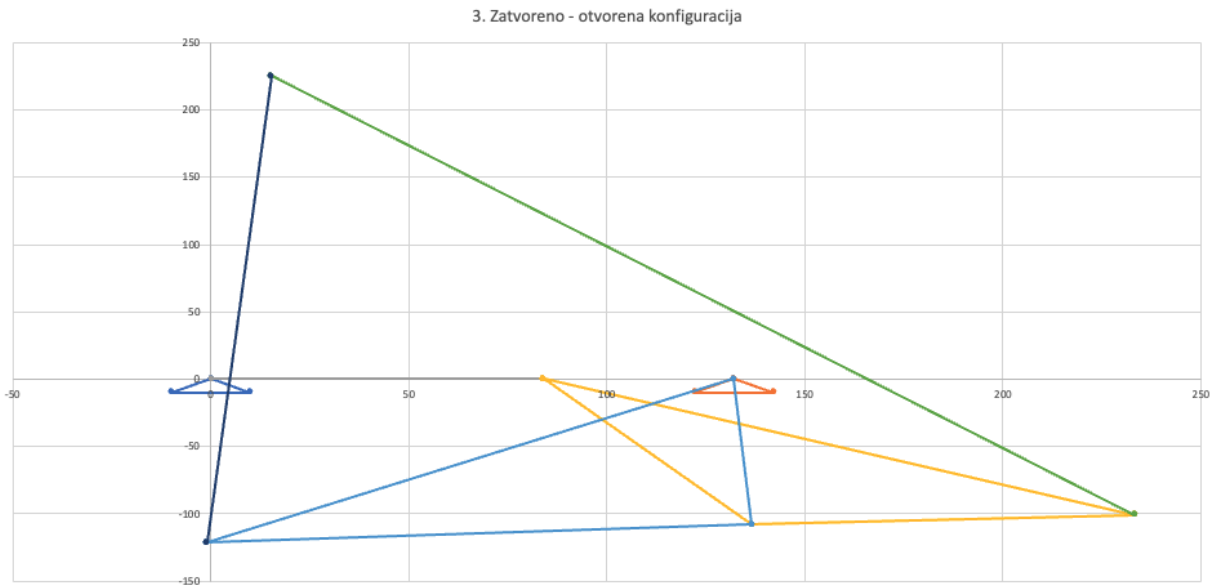

*Slika 5.11. Zatvoreno - otvorena konfiguracija ( $\theta_2 = 0^\circ$ )*

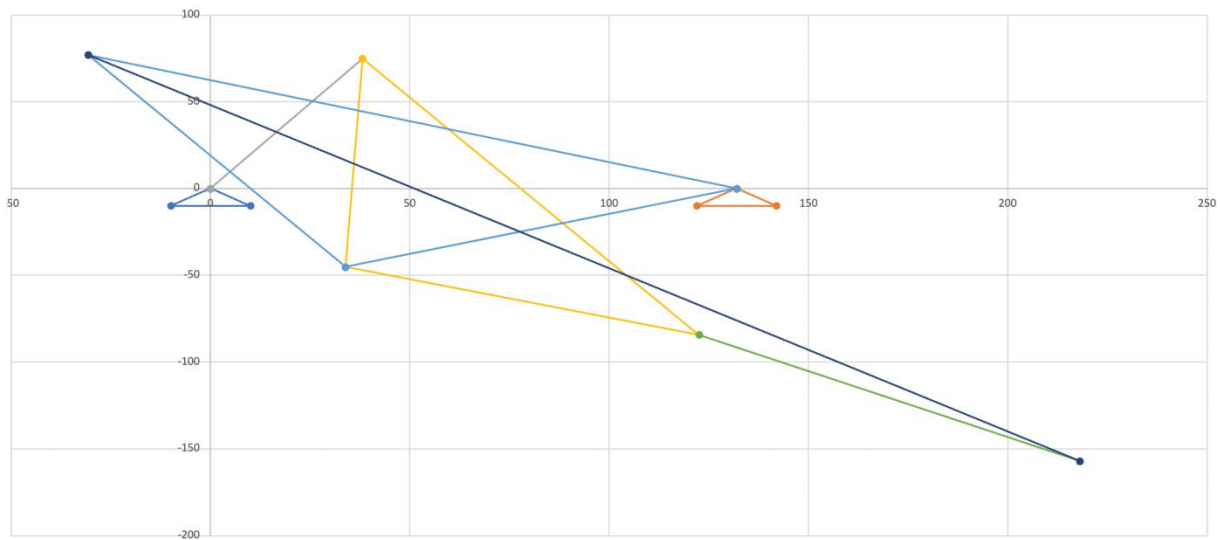

*Slika 5.12. Zatvoreno - otvorena konfiguracija ( $\theta_2 = 63^\circ$ )*

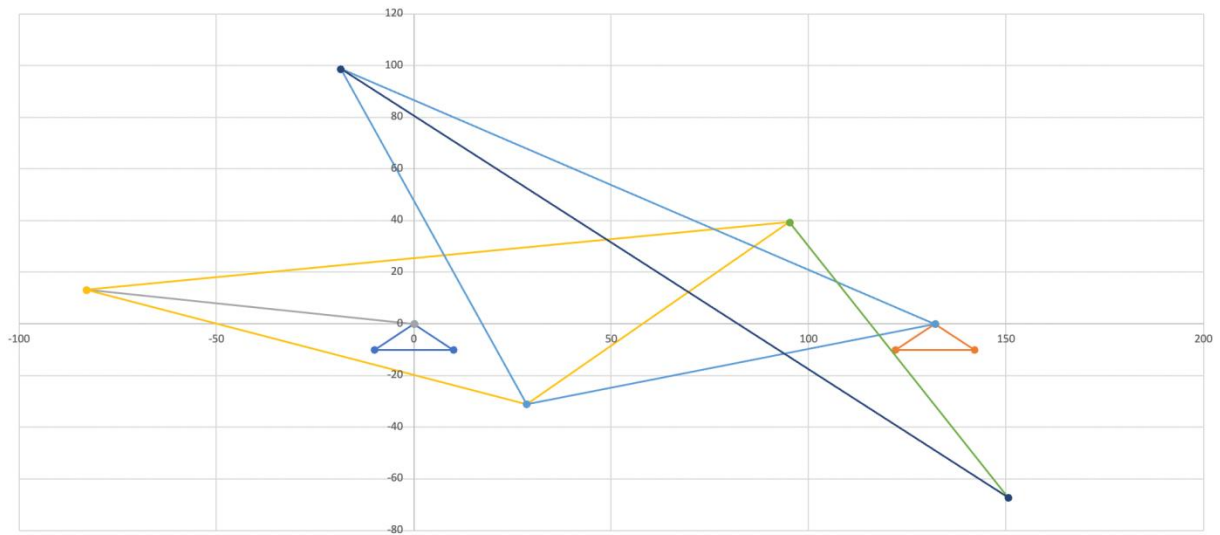

*Slika 5.13. Zatvoreno - otvorena konfiguracija ( $\theta_2 = 171^\circ$ )*

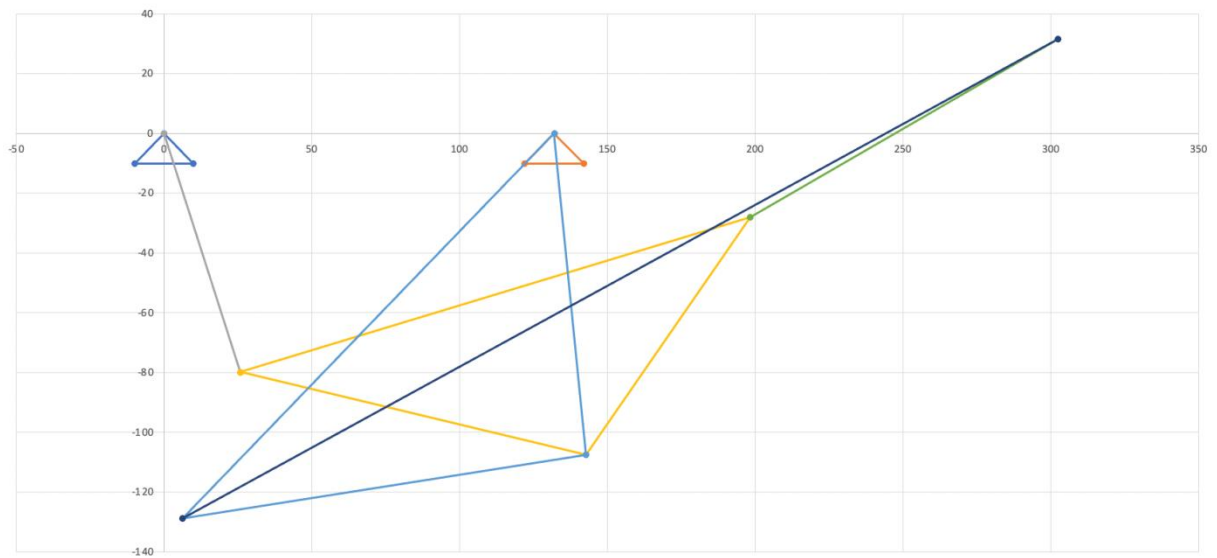

*Slika 5.14. Zatvoreno - otvorena konfiguracija ( $\theta_2 = 288^\circ$ )*

## 5.5 Prikaz gibanja mehanizma (zatvoreno-zatvorena konfiguracija)

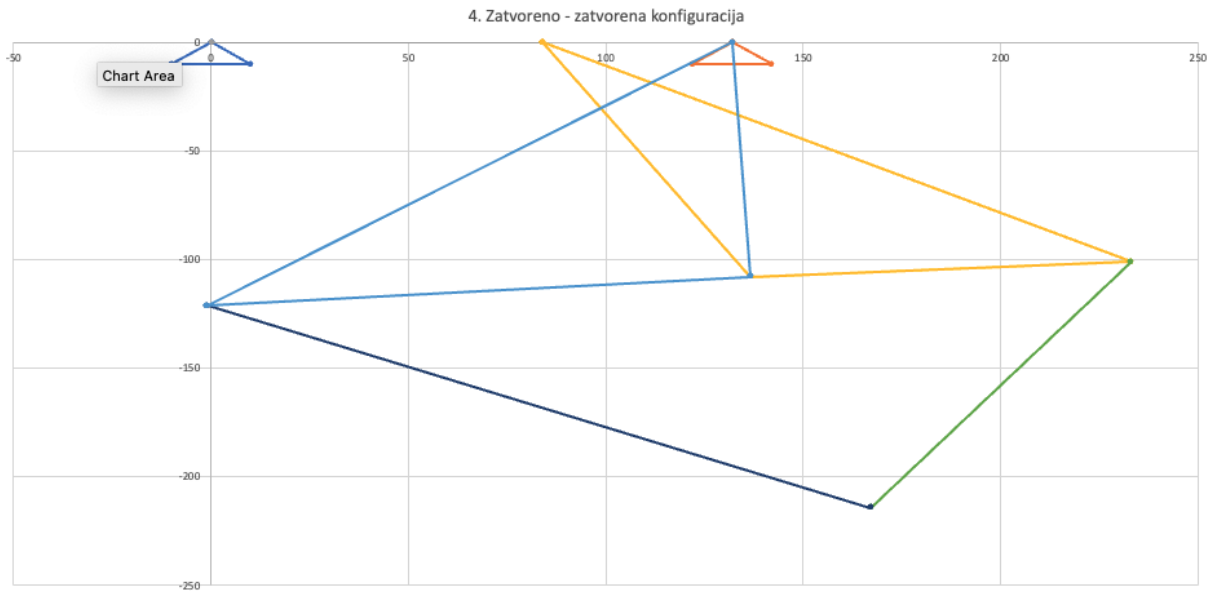

*Slika 5.15. Zatvoreno - zatvorena konfiguracija ( $\theta_2 = 0^\circ$ )*

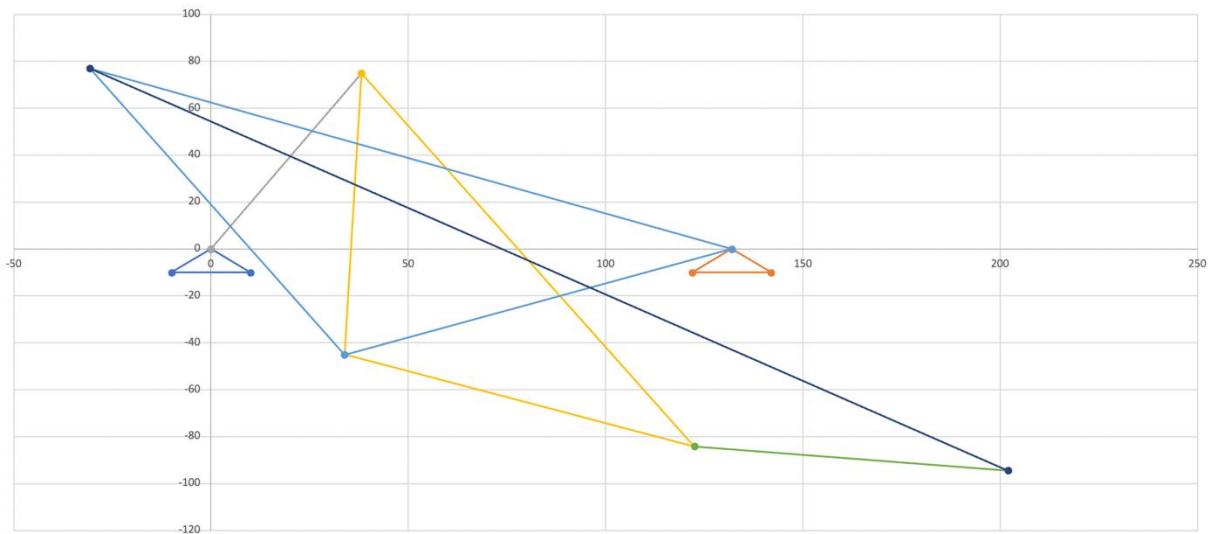

*Slika 5.16. Zatvoreno - zatvorena konfiguracija ( $\theta_2 = 63^\circ$ )*

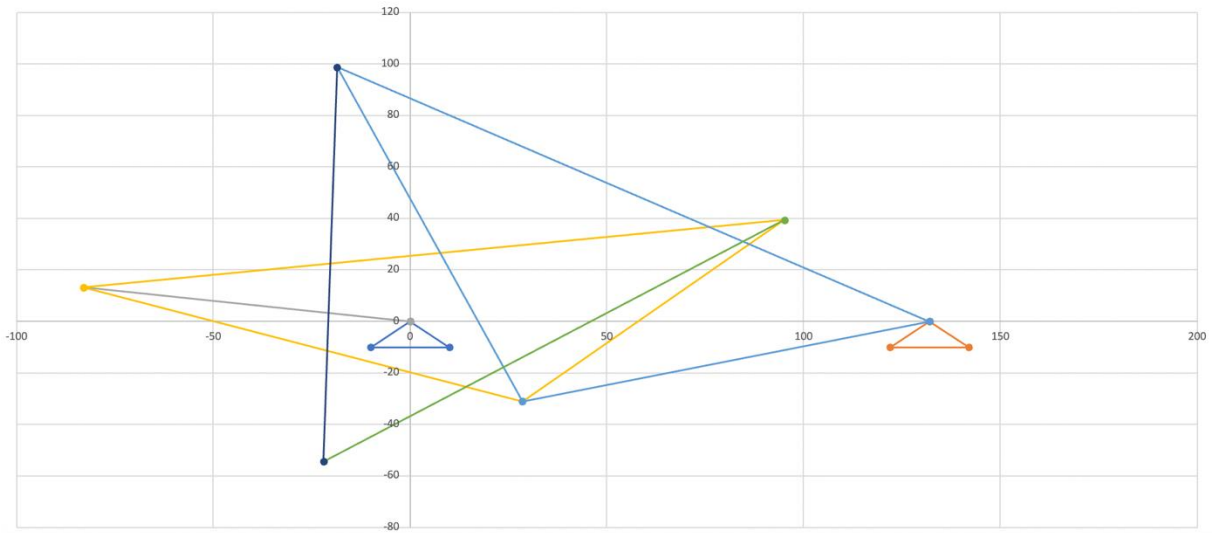

**Slika 5.17.** *Zatvoreno - zatvorena konfiguracija ( $\theta_2 = 171^\circ$ )*

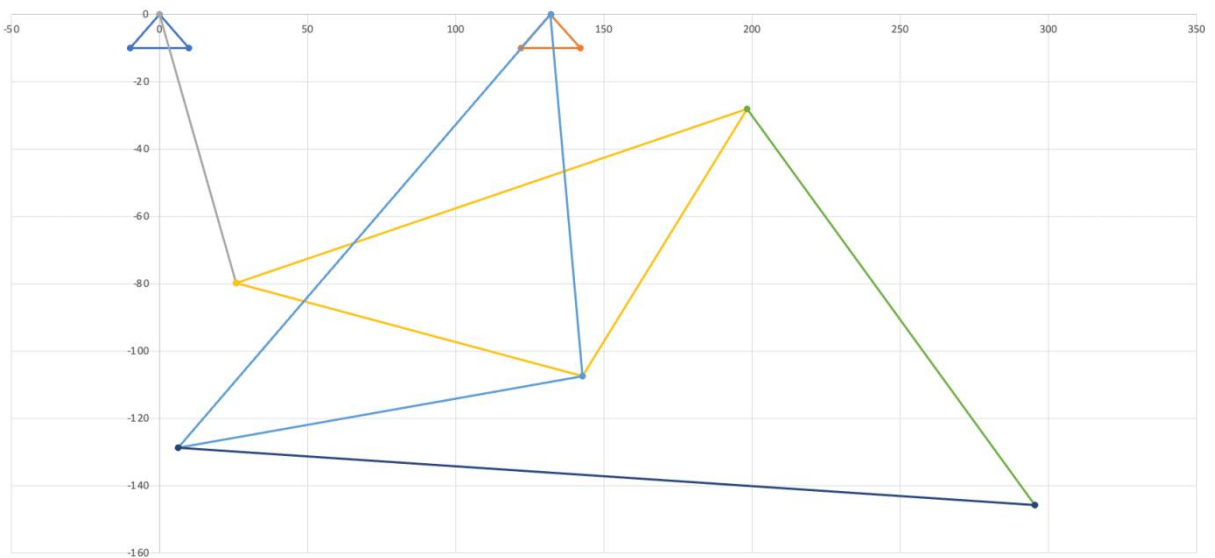

**Slika 5.18.** *Zatvoreno - zatvorena konfiguracija ( $\theta_2 = 288^\circ$ )*

## 6. ZAKLJUČAK

Wattov 6-segmentni mehanizmi su mehanizma sa složenim putanjama gibanja zglobova koji su jako učinkoviti ukoliko u slučaju kompleksnih gibanja segmenata ili zglobova. Proračuni kinematičke i dinamičke analize su zahtjevni i zahtijevaju puno koraka. Program Excel pruža nam savršen alat za rješavanje takvih kompleksnih proračuna. Sva rješenja su spremljena u tablicu i lako se prikazuju.

Rješenja matrica odnosno simulaciju gibanja mehanizma u Excelu lako je prikazati te se ulazni podaci mogu lako korigirati po potrebi.

Ovim završnim radom, analizirali smo uspješno kompleksni Wattov I. mehanizam čija rješenja pružaju nam uvid u kompleksnost ovakvog tipa mehanizma.

## LITERATURA

- [1] Žigulić, R.; Braut, S.: „Kinematika“, Tehnički fakultet Sveučilište u Rijeci, 2012.
- [2] Krpan, M.; Butković, M.; Franulović, A.; Žigulić, R.; Braut, S.: „Dinamika – teorija i primjena“, Tehnički fakultet Sveučilište u Rijeci, 2001.
- [3] Dyer, K.B.; Constans. E.: „Introduction to mechanism design with computer applications“, CRC Press, Taylor & Francis Group, Broken Sound Parkway NW, 2019.
- [4] Russel, K.; Shen, Q.; Sodhi, R.S.: „Kinematics and Dynamics of Mechanical Systems Implementation in MATLAB and SimMechanics“, CRC Press, Taylor & Francis Group, Broken Sound Parkway NW, 2016.
- [5] Mata, A. S. „i drugi“: „Fundamentals of Machine Teory and Mechanisms“, Springer, Switzerland, 2016.



## POPIS SLIKA

- Slika 1.1. Klannov hodajući mehanizam
- Slika 2.2. Stephensonov I. tip i Wattov I. tip mehanizma
- Slika 1.3. Stephensonov II. tip i Wattov II. tip mehanizma
- Slika 1.4. Stephensonov III. tip mehanizma
- Slika 2.1. Wattov I. mehanizma – primjer
- Slika 2.2. Otvoreno-otvorena konfiguracija Wattovog I. mehanizma
- Slika 2.3. Otvoreno-zatvorena konfiguracija Wattovog I. mehanizma
- Slika 2.4. Početni položaj mehanizma
- Slika 2.5. Vektorski prikaz donjeg 4-segmentnog mehanizma
- Slika 2.6. Vektorski zbroj gornjeg 5-članog mehanizma
- Slika 3.1. Segmenti Wattovog I. mehanizma
- Slika 3.2. Segmenti Wattovog II. mehanizma
- Slika 3.3. Sile koje se javljaju u pojedinim segmentima
- Slika 3.4. Vektor „r“ i sile u zglobovima
- Slika 4.1. Ulazni podaci Wattovog I. tipa mehanizma
- Slika 4.2. Konstante
- Slika 4.3. Konstante ovisne o kutu pogonske ploče,  $\vartheta_2$
- Slika 4.4. Promjena kuta  $\vartheta_3$  u ovisnosti o  $\vartheta_2$
- Slika 4.5. Promjena kuta  $\vartheta_4$  u ovisnosti o kutu  $\vartheta_2$
- Slika 4.6. Koordinate točaka
- Slika 4.7. Kut  $\alpha$  i  $\beta$
- Slika 4.8. Kutovi  $\vartheta'_{21}$  i  $\vartheta'_{22}$
- Slika 4.9. Koeficijenti (otvorena konfiguracija)
- Slika 4.10. Koeficijenti (zatvorena konfiguracija)
- Slika 4.11. Kut  $\vartheta_5$  (otvorena i zatvorena konfiguracija)
- Slika 4.12. Kut  $\vartheta_6$  (otvorena i zatvorena konfiguracija)
- Slika 4.13. Koordinate točke G (otvorena i zatvorena konfiguracija)
- Slika 4.14. Kutne brzine Wattovog I. tipa mehanizma
- Slika 4.15. Kutna ubrzanja Wattovog I. tipa mehanizma
- Slika 4.16. Težišta elemenata

Slika 4.17. Ubrzanja točaka težišta  
Slika 4.18. Ubrzanja točaka težišta  
Slika 4.19. Matrica A  
Slika 4.20. Mase pojedinih elemenata mehanizma  
Slika 4.21. Inercijski momenti  
Slika 4.22. Vektor B  
Slika 4.23. Rješenje, matrice sila otvorene konfiguracije  
Slika 5.1. Koordinate oslonaca Watt I. mehanizma  
Slika 5.2. Koordinate segmenata mehanizma  
Slika 5.3. Otvoreno - otvorena konfiguracija ( $\theta_2 = 0^\circ$ )  
Slika 5.4. Otvoreno - otvorena konfiguracija ( $\theta_2 = 63^\circ$ )  
Slika 5.5. Otvoreno - otvorena konfiguracija ( $\theta_2 = 171^\circ$ )  
Slika 5.6. Otvoreno - otvorena konfiguracija ( $\theta_2 = 288^\circ$ )  
Slika 5.7. Otvoreno - zatvorena konfiguracija ( $\theta_2 = 0^\circ$ )  
Slika 5.8. Otvoreno - zatvorena konfiguracija ( $\theta_2 = 63^\circ$ )  
Slika 5.9. Otvoreno - zatvorena konfiguracija ( $\theta_2 = 171^\circ$ )  
Slika 5.10. Otvoreno - zatvorena konfiguracija ( $\theta_2 = 288^\circ$ )  
Slika 5.11. Zatvoreno - otvorena konfiguracija ( $\theta_2 = 0^\circ$ )  
Slika 5.12. Zatvoreno - otvorena konfiguracija ( $\theta_2 = 63^\circ$ )  
Slika 5.13. Zatvoreno - otvorena konfiguracija ( $\theta_2 = 171^\circ$ )  
Slika 5.14. Zatvoreno - otvorena konfiguracija ( $\theta_2 = 288^\circ$ )  
Slika 5.15. Zatvoreno - zatvorena konfiguracija ( $\theta_2 = 0^\circ$ )  
Slika 5.16. Zatvoreno - zatvorena konfiguracija ( $\theta_2 = 63^\circ$ )  
Slika 5.17. Zatvoreno - zatvorena konfiguracija ( $\theta_2 = 171^\circ$ )  
Slika 5.18. Zatvoreno - zatvorena konfiguracija ( $\theta_2 = 288^\circ$ )

## POPIS OZNAKA

$r$  - duljina štapa

$\theta$  - kut položaja štapa

$\gamma$  - kut ploče

$\alpha$  i  $\beta$  - kutovi virtualne poluge

$\omega$  - kutna brzina

$\varepsilon$  - kutno ubrzanje

$F$  - sila

$m$  - masa

$a$  - ubrzanje

$T_x$  - koordinata težišta po osi  $x$

$T_y$  - koordinata težišta po osi  $y$

$r_x$  - udaljenost po osi  $x$

$r_y$  - udaljenost po osi  $y$

$s_x$  - krak sile po  $x$  osi

$s_y$  - krak sile po  $y$  osi

$J$  - moment tromosti

## SAŽETAK

Cilj ovog završnog rada je bila kinematička i dinamička analiza Wattovog 6-segmentnog mehanizma prvog tipa u programu Microsoft Office Excell. Iz ulaznih podataka, koji su veličina štapova i kut pogonskog člana, postavljanjem vektorskih jednadžbi položaja segmenata dobivena su prvo rješenja kinematičke analize i nakon toga derivacijom istih vektorskih jednadžbi dobivena su i rješenja dinamičke analize.

Dobivene jednadžbe su upisane u program Microsoft Office Excell, te su dobiveni rezultati u tablici za određeni broj kutova pogonskog člana, koordinate položaja, kutne brzine, kutna ubrzanja i sile. Gibanje mehanizma je prikazano pomoću programa.

Ključne riječi: 6-segmentni mehanizam, Wattov mehanizam, kinematička analiza, dinamička analiza

## **SUMMARY**

The aim of this work was the kinematic and dynamic analysis of Watt's 6-segment mechanism of its first type in Microsoft Office Excel. From the input data, which are the size of the rods and the angle of the drive member, the solutions of the kinematic analysis were first obtained by setting the vector equations of the position of the segments, and then the solutions of the dynamic analysis were obtained by deriving the same vector equations.

The resulting equations were entered into the Microsoft Office Excel program, and the results were obtained in a table for a certain number of angles of the driving member, position coordinates, angular velocities, angular accelerations and forces. The movement of the mechanism is shown using the program.

**Key words:** 6-segment mechanism, Watt mechanism, kinematic analysis, dynamic analysis