

Radionički nacrt sekcije dvoboka 3350

Marelić, Dario

Supplement / Prilog

Publication year / Godina izdavanja: **2022**

Permanent link / Trajna poveznica: <https://urn.nsk.hr/urn:nbn:hr:190:531470>

Rights / Prava: [Attribution 4.0 International](#)/[Imenovanje 4.0 međunarodna](#)

Download date / Datum preuzimanja: **2025-01-08**



Repository / Repozitorij:

[Repository of the University of Rijeka, Faculty of Engineering](#)



ORD. 87, ORD. 91, ORD. 95, ORD. 99,
ORD. 107, ORD. 111

PROFILI 150*11 OSIM OZNAČENIH
DESNO SIMETRIČNO

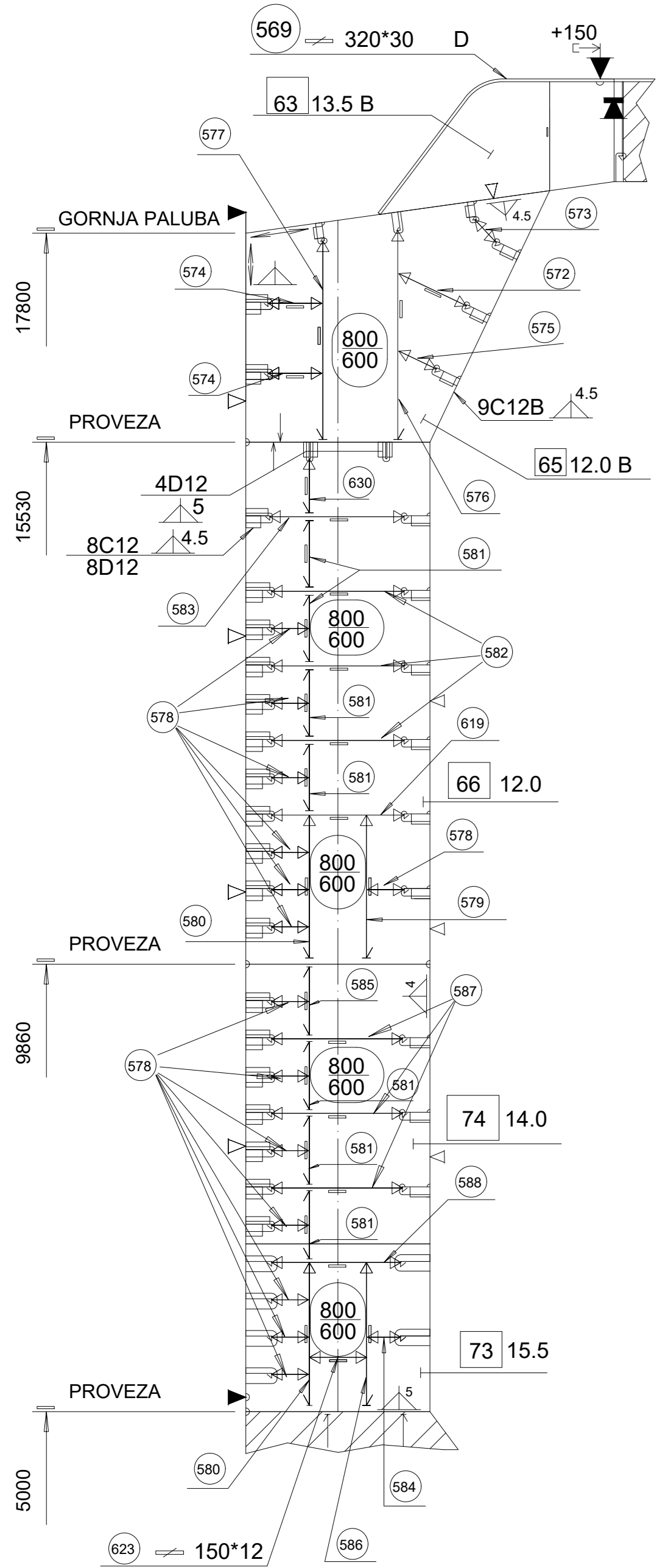

ORD. 103

PROFILI 150*12 OSIM OZNAČENIH
DESNO SIMETRIČNO

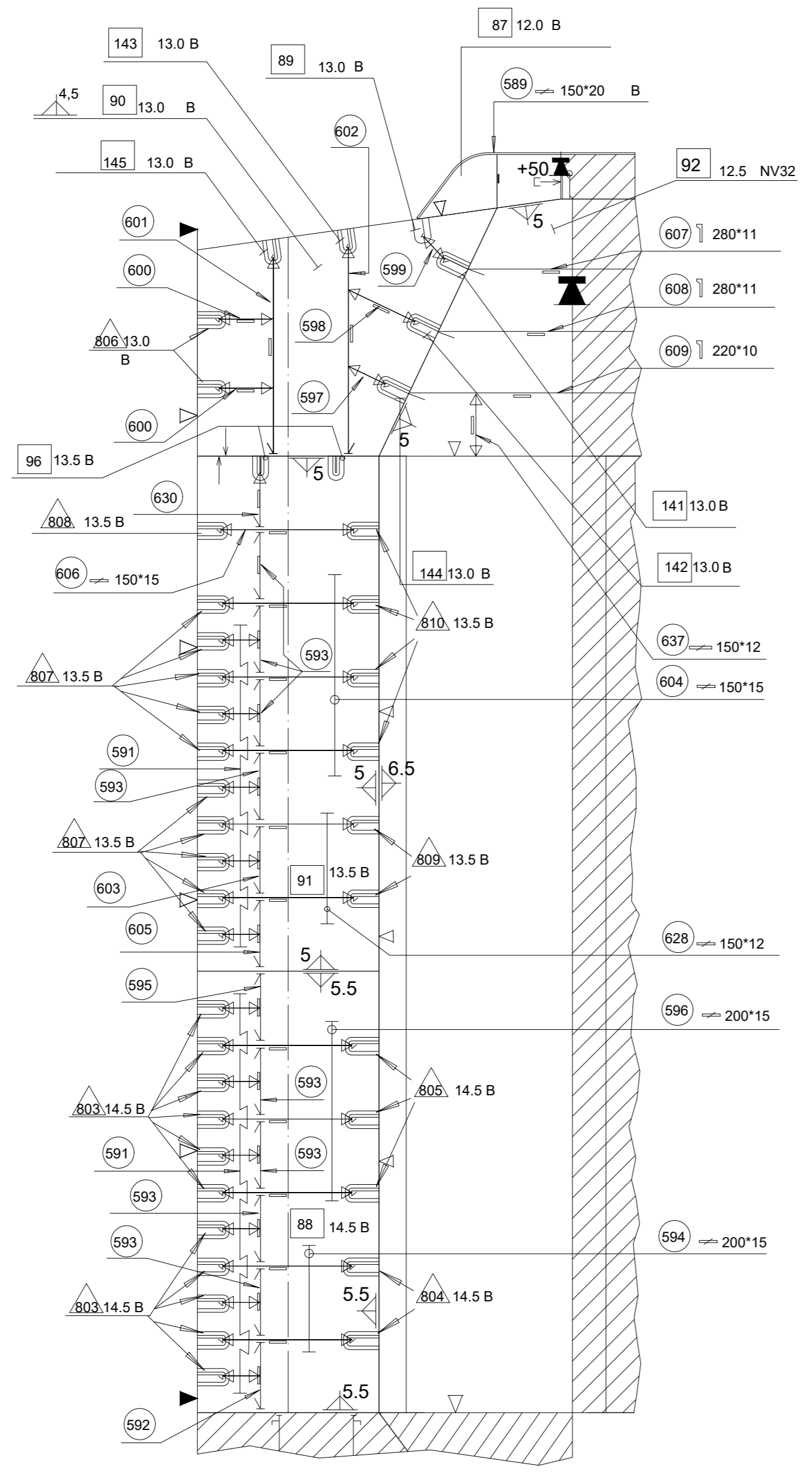

GORNJA PALUBA
200*11,5 B

T11,21 T12,22

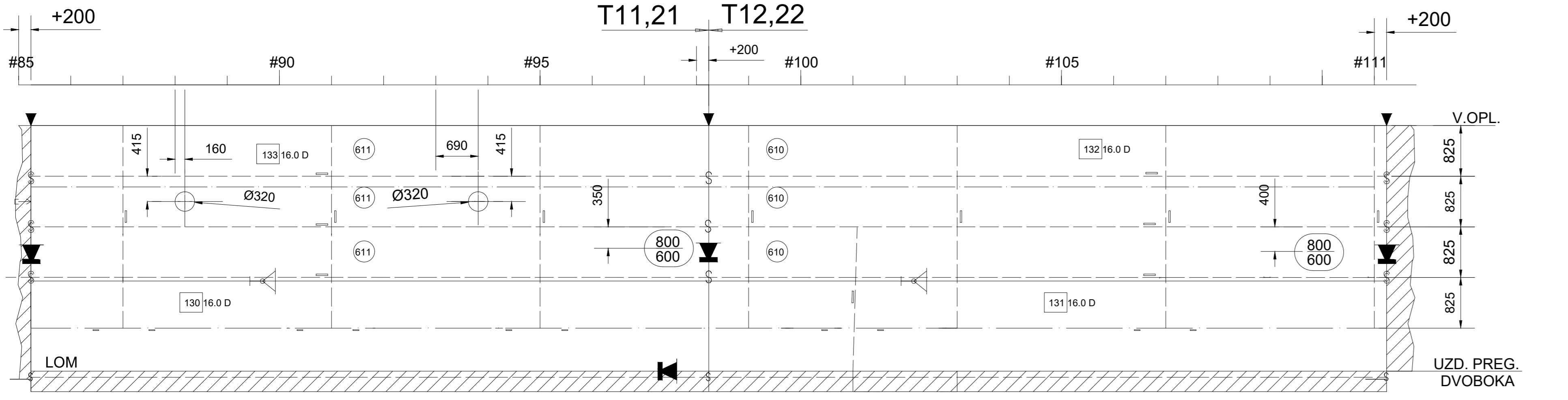

PROVEZA NA 15530 OD OSN.
180*12

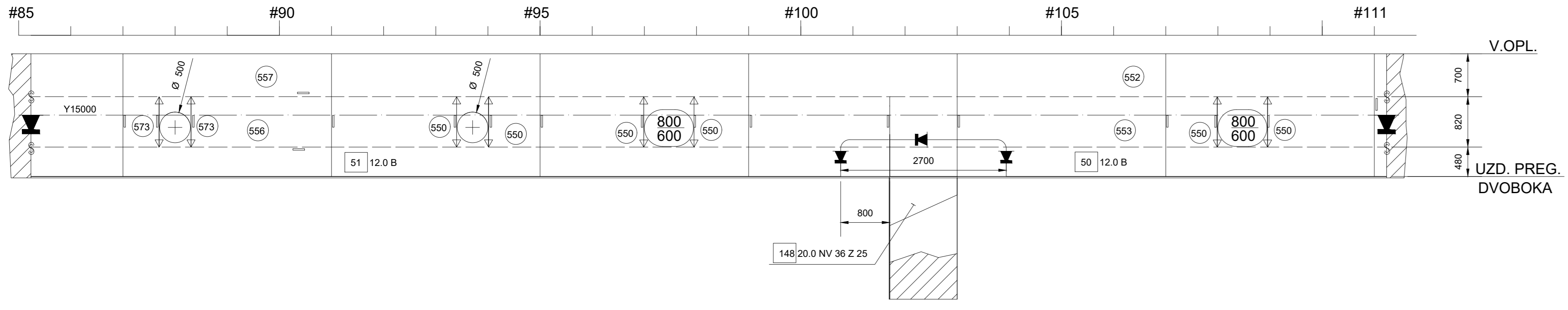

PROVEZA NA 9860 OD OSN.
180*12

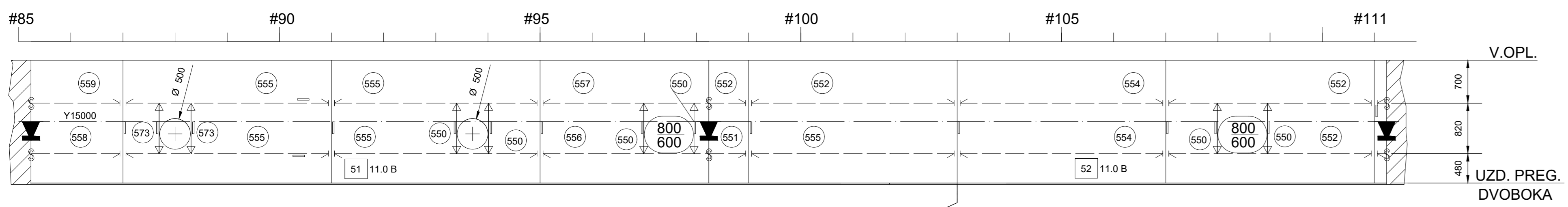

UZDUŽNA PREGRADA DVOBOKA

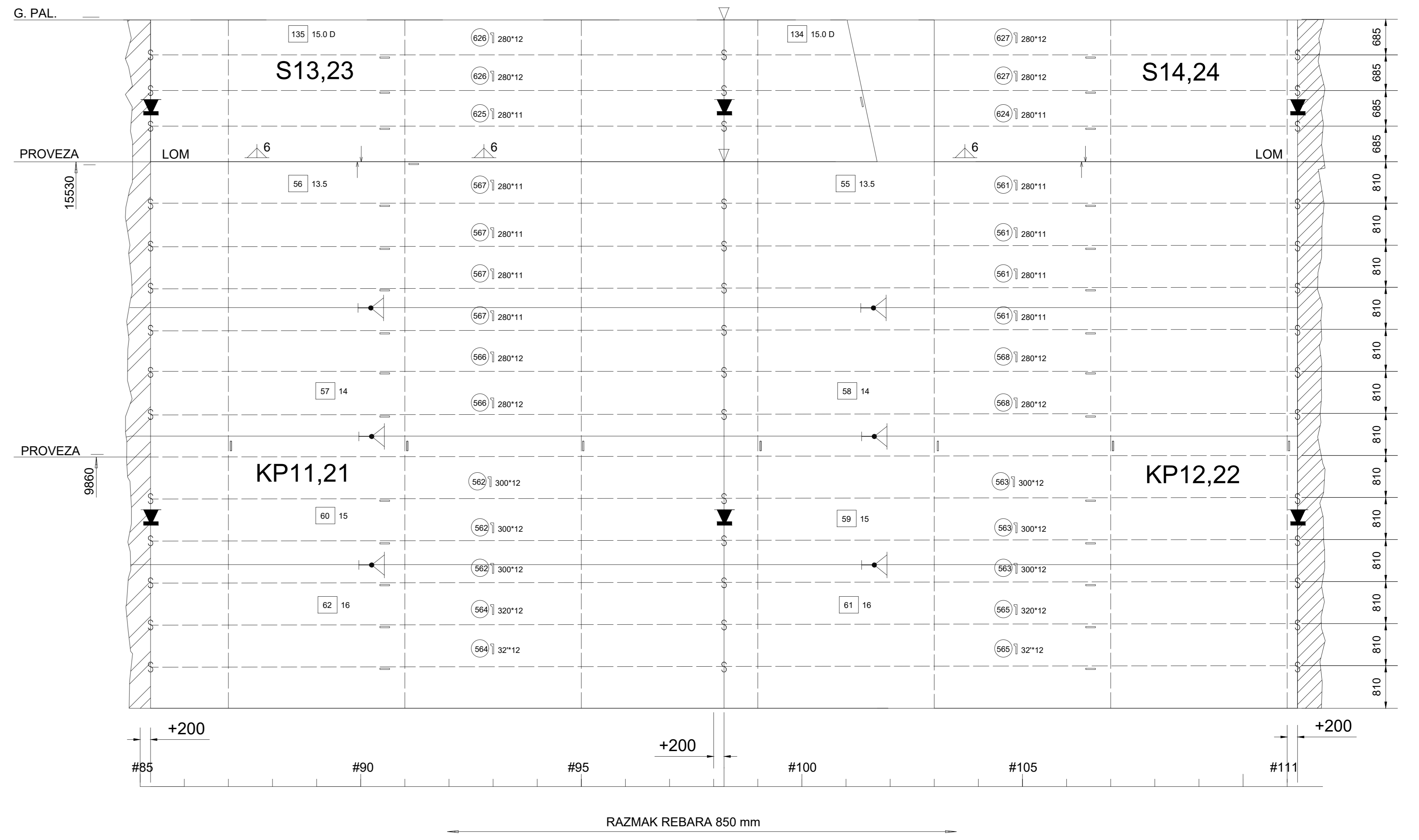

IZOMETRIJSKI PRIKAZ
M 1:100

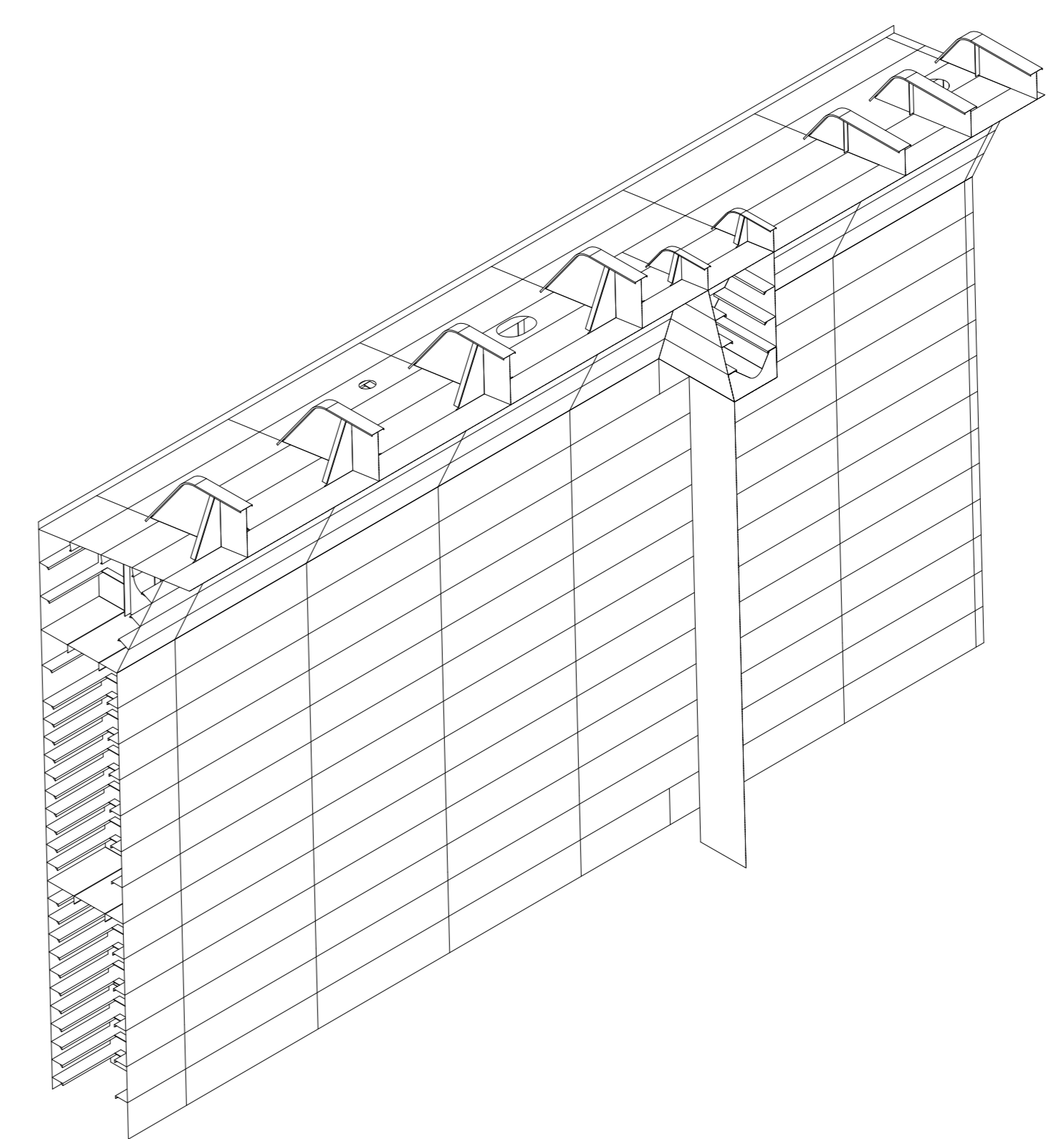

DESIGNED BY: Student Dario Blaretić	DVOBOK	M	—
DATE: 7/19/2022		L	—
CHECKED BY: XXX	DASSAULT SYSTEMES	K	—
DATE: XXX		J	—
SIZE: A0	WEIGHT (KG): XXX	H	—
SCALE: 1:50	DRAWING NUMBER: XXX	G	—
		F	—
		E	—
		D	—
		C	—
		B	—
		A	—