

# Radionički nacrt sekcije dvoboka 3350

---

**Marelić, Dario**

## Supplement / Prilog

Publication year / Godina izdavanja: **2022**

Permanent link / Trajna poveznica: <https://urn.nsk.hr/urn:nbn:hr:190:531470>

Rights / Prava: [Attribution 4.0 International](#)/[Imenovanje 4.0 međunarodna](#)

Download date / Datum preuzimanja: **2024-08-04**



Repository / Repozitorij:

[Repository of the University of Rijeka, Faculty of Engineering](#)



ORD. 87, ORD. 91, ORD. 95, ORD.99,  
ORD. 107, ORD. 111

PROFILI 150\*11 OSIM OZNAČENIH  
DESNO SIMETRIČNO

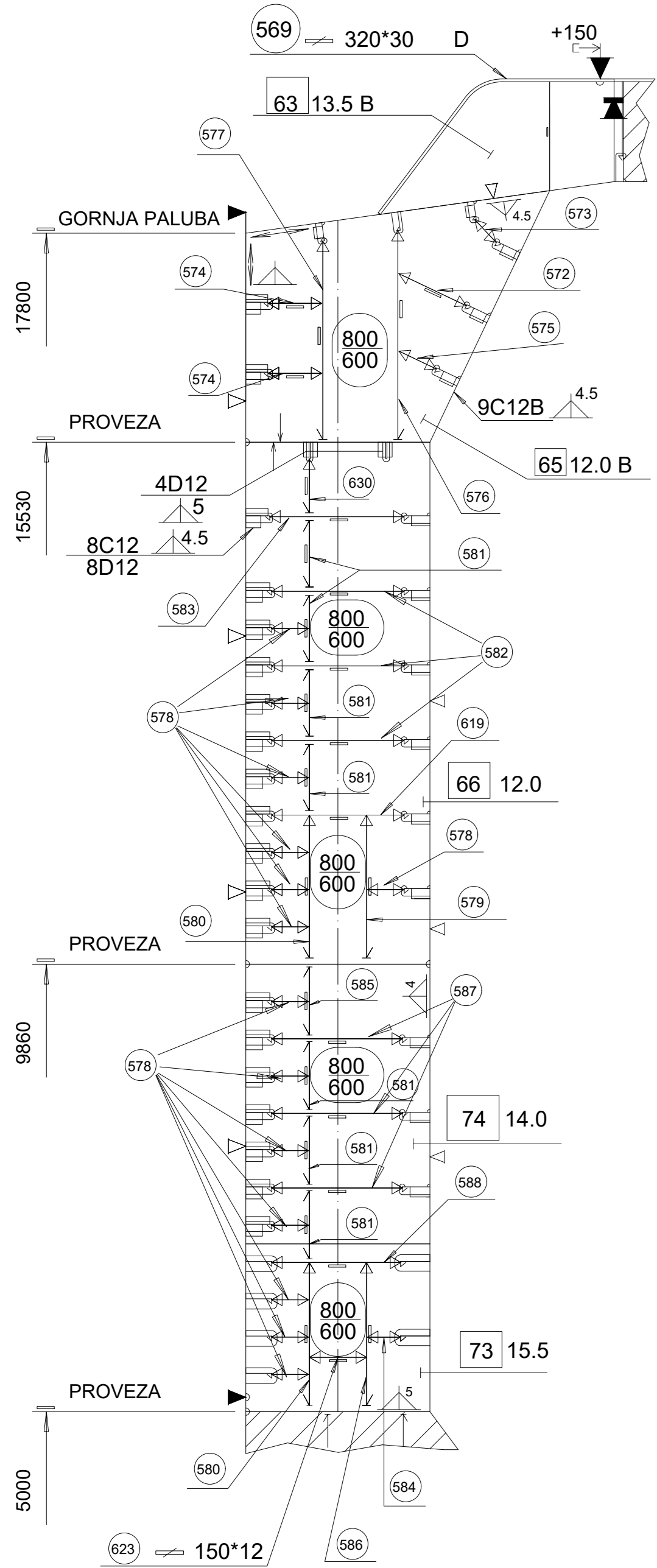

ORD. 103

PROFILI 150\*12 OSIM OZNAČENIH  
DESNO SIMETRIČNO

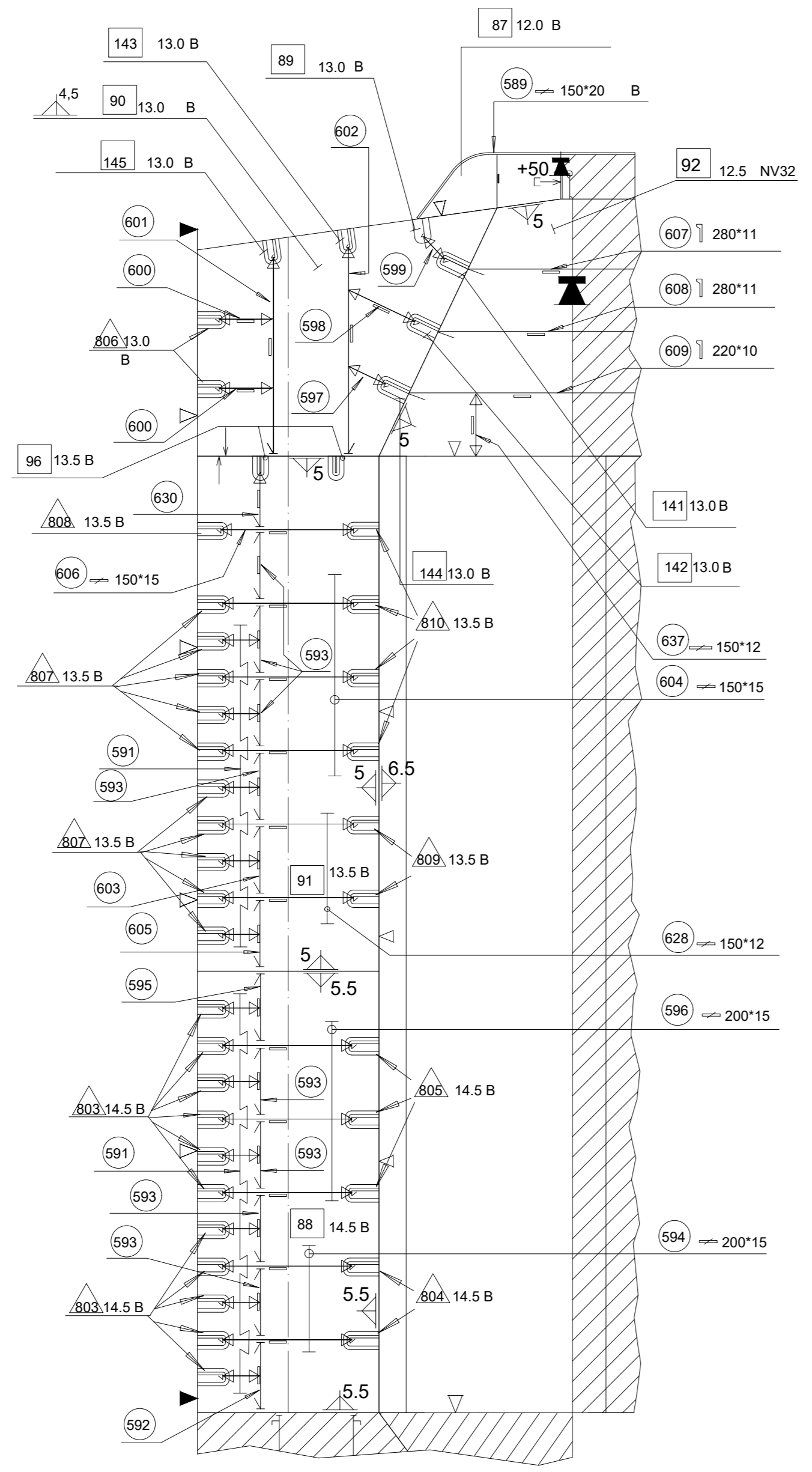

GORNJA PALUBA  
200\*11,5 B

T11,21 T12,22

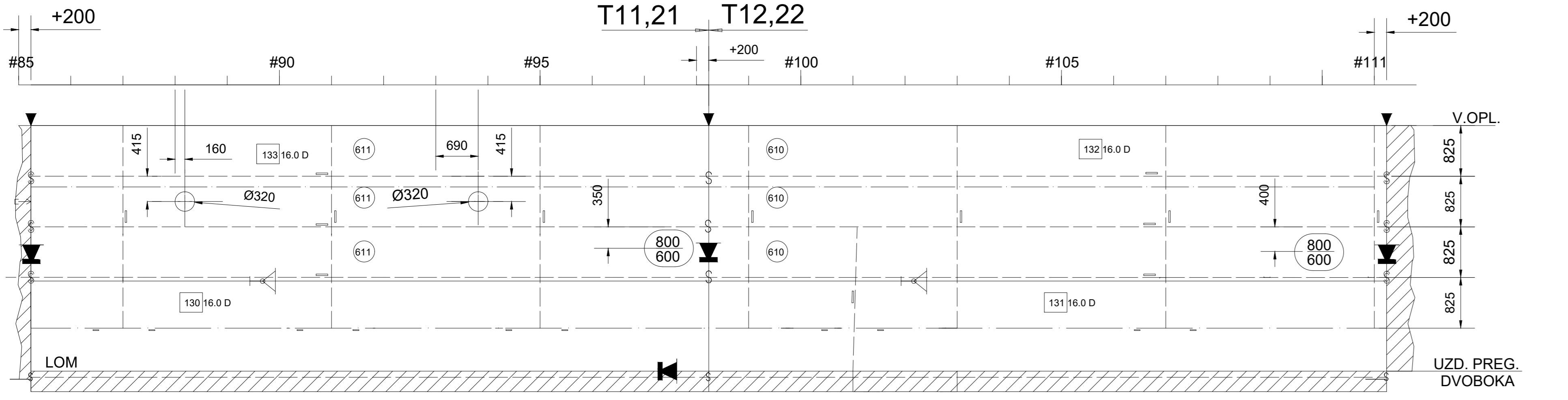

PROVEZA NA 15530 OD OSN.  
180\*12

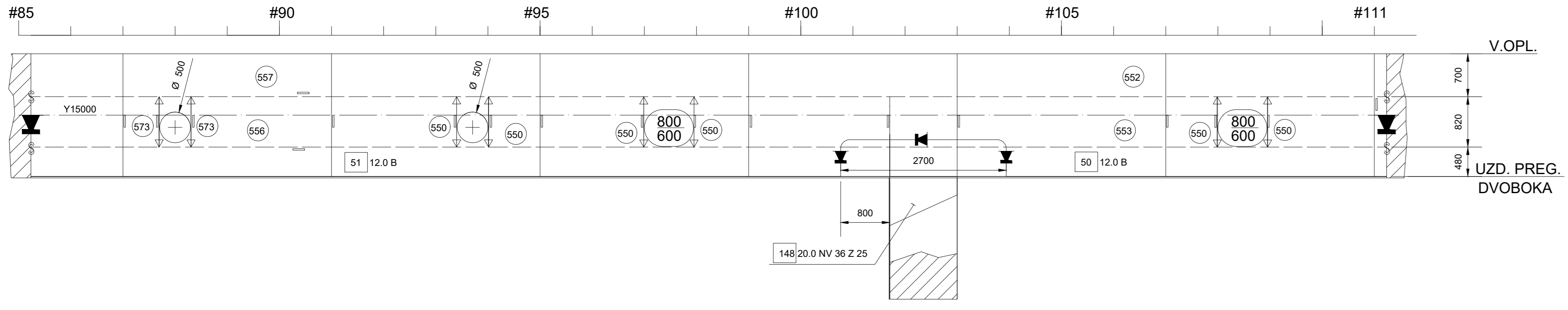

PROVEZA NA 9860 OD OSN.  
180\*12

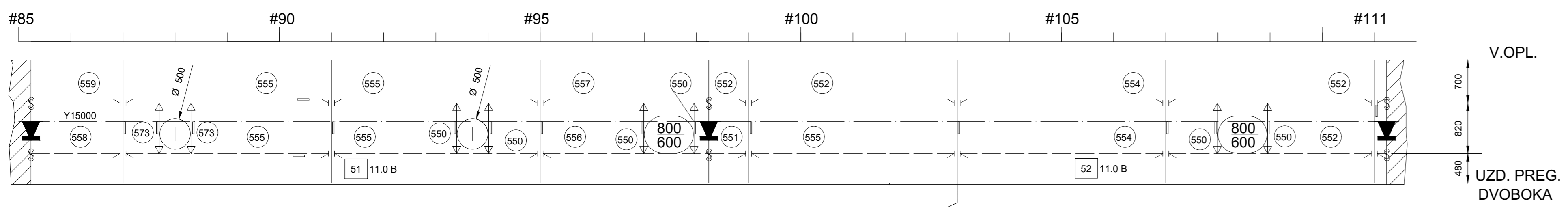

UZDUŽNA PREGRADA DVOBOKA

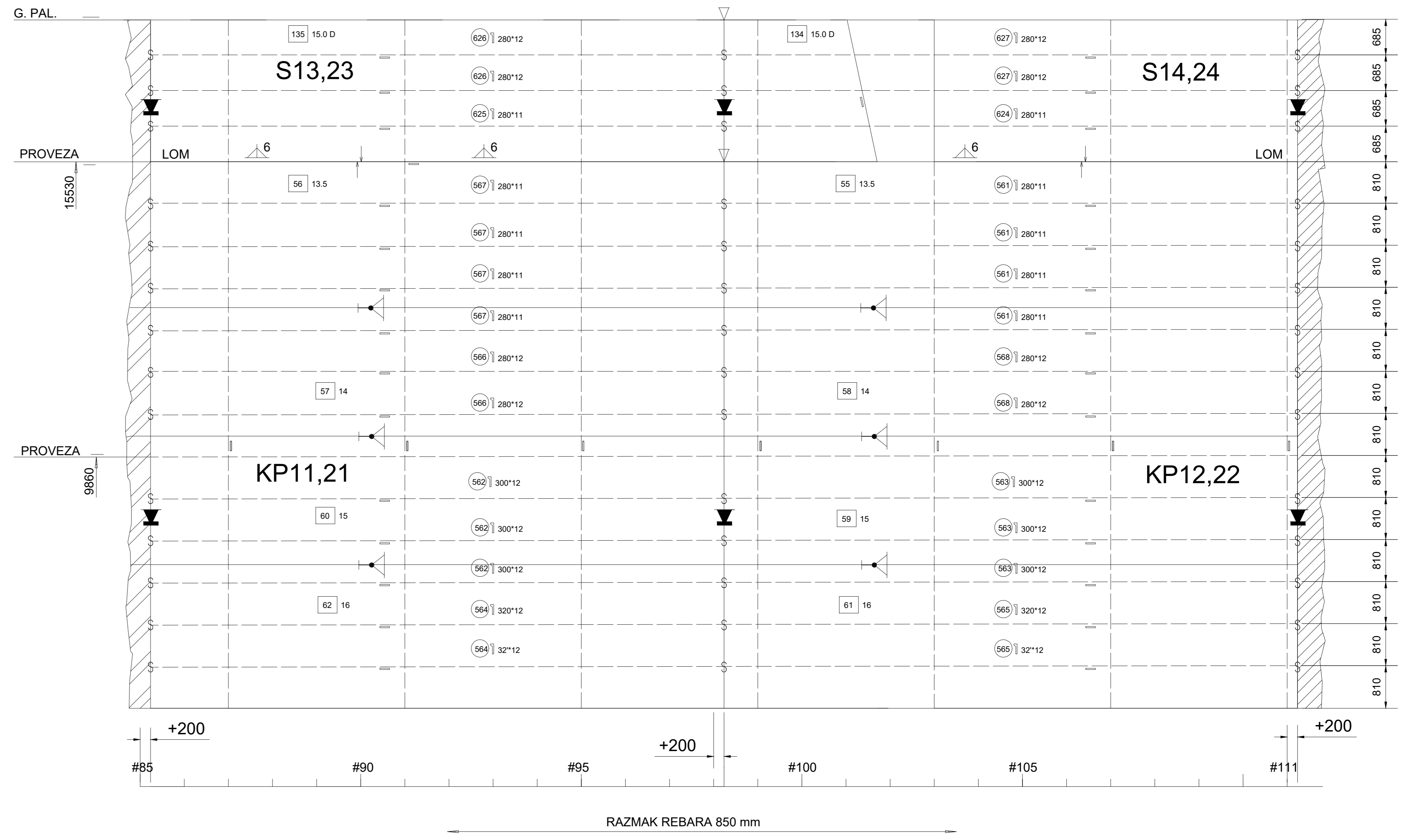

IZOMETRIJSKI PRIKAZ  
M 1:100

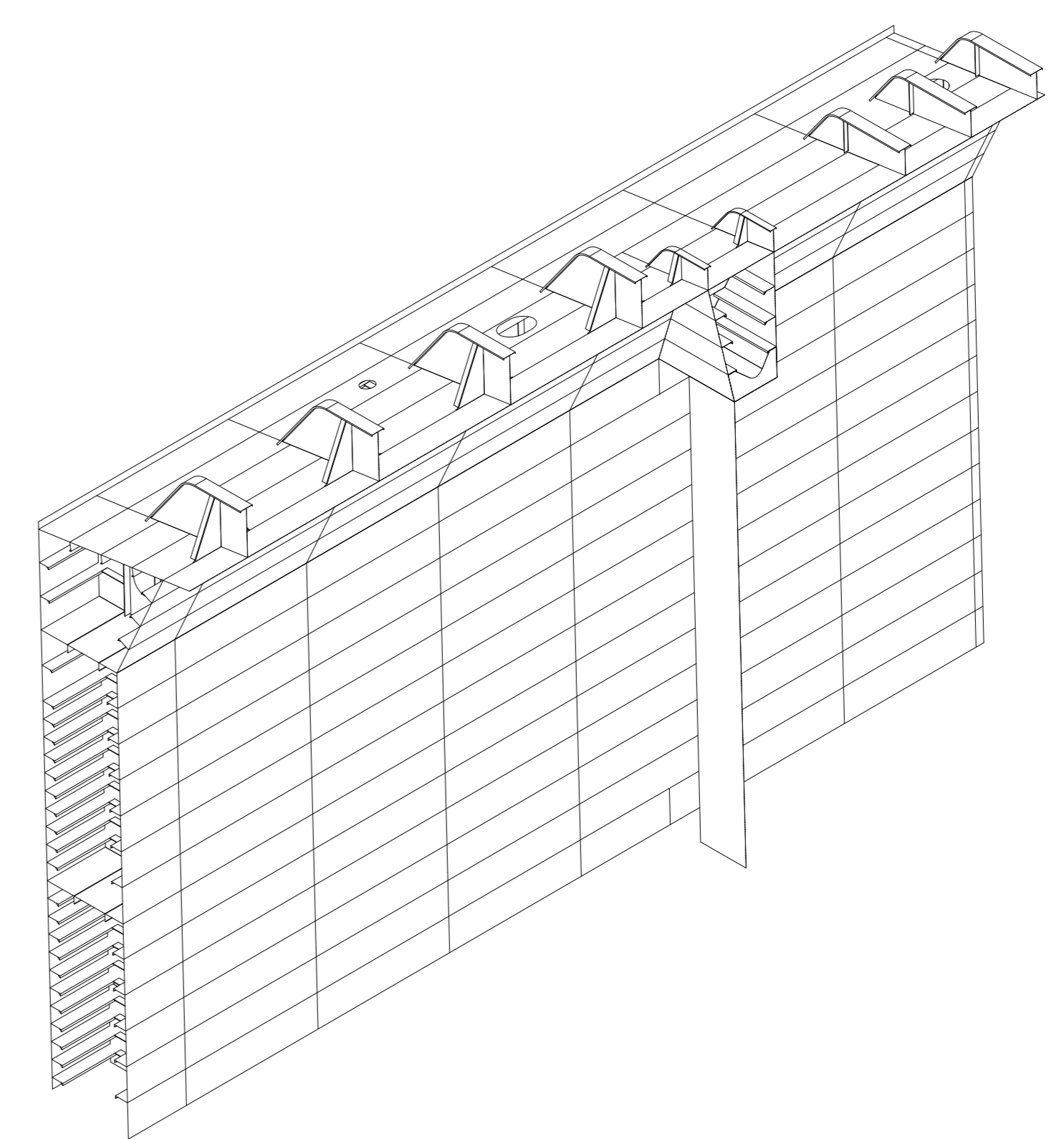

DESIGNED BY: Student Dario Blaretić	<b>DVOBOK</b>	M	—
DATE: 7/19/2022		L	—
CHECKED BY: XXX	<b>DASSAULT SYSTEMES</b>	K	—
DATE: XXX		J	—
SIZE: A0	WEIGHT (KG): XXX	H	—
SCALE: 1:50	DRAWING NUMBER: XXX	G	—
		F	—
		E	—
		D	—
		C	—
		B	—
		A	—